

INSTRUCTION MANUAL FOR



BLUED &
STAINLESS
STEEL

CALIBER
9mm, 40 S&W, &
45 Auto

RUGER® SR-SERIES

SR9®, SR9c®, SR40®, SR40c®, SR45™ & 9E™
MANUAL SAFETY MODEL PISTOLS



– Rugged, Reliable Firearms® –



**READ THE INSTRUCTIONS AND
WARNINGS IN THIS MANUAL CAREFULLY
BEFORE USING THIS FIREARM**

© 2014 Sturm, Ruger & Co., Inc.

This manual may not be reproduced in whole or in part without the express written permission of Sturm, Ruger & Co., Inc.

**For Service on This Model Please Call:
(928) 541-8892 (See p. 36)**

THIS INSTRUCTION MANUAL SHOULD ALWAYS ACCOMPANY THIS FIREARM AND BE
TRANSFERRED WITH IT UPON CHANGE OF OWNERSHIP, OR WHEN THE FIREARM IS LOANED
OR PRESENTED TO ANOTHER PERSON

www.ruger.com

VS & KVS 7/15A
R8

State-By-State Warnings

Certain states require by law that their own specified warning notices in larger-than-normal type be conspicuously included by the manufacturer, distributor or retailer with firearms sold in that state. Sturm, Ruger & Co., Inc. sells its products in compliance with applicable laws and regulations. Because our products may be sold in these states, we include the following:

California:

WARNING

“Children are attracted to and can operate firearms that can cause severe injuries or death. Prevent child access by always keeping guns locked away and unloaded when not in use. If you keep a loaded firearm where a child obtains and improperly uses it, you may be fined or sent to prison.”

ADVERTENCIA

“A los niños los atraen las armas de fuego y las pueden hacer funcionar. Ellos pueden causarse lesiones graves y la muerte. Evite que los niños tengan acceso a las armas de fuego guardándolas siempre con llave y descargadas cuando no las esté utilizando. Si usted tiene un arma de fuego cargada en un lugar en que un niño tiene acceso a ella y la usa indebidamente, le pueden dar una multa o enviarlo a la cárcel.”

Connecticut:

“UNLAWFUL STORAGE OF A LOADED FIREARM MAY RESULT IN IMPRISONMENT OR FINE.”

Florida:

“IT IS UNLAWFUL, AND PUNISHABLE BY IMPRISONMENT AND FINE, FOR ANY ADULT TO STORE OR LEAVE A FIREARM IN ANY PLACE WITHIN THE REACH OR EASY ACCESS OF A MINOR UNDER 18 YEARS OF AGE OR TO KNOWINGLY SELL OR OTHERWISE TRANSFER OWNERSHIP OR POSSESSION OF A FIREARM TO A MINOR OR A PERSON OF UNSOUND MIND.”

Maine:

“ENDANGERING THE WELFARE OF A CHILD IS A CRIME. IF YOU LEAVE A FIREARM AND AMMUNITION WITHIN EASY ACCESS OF A CHILD, YOU MAY BE SUBJECT TO FINE, IMPRISONMENT OR BOTH. KEEP FIREARMS AND AMMUNITION SEPARATE. KEEP FIREARMS AND AMMUNITION LOCKED UP. USE TRIGGER LOCKS.”

Maryland:

“WARNING: Children can operate firearms which may cause death or serious injury. It is a crime to store or leave a loaded firearm in any location where an individual knew or should have known that an unsupervised minor would gain access to the firearm. Store your firearm responsibly!”

Massachusetts:

“WARNING FROM THE MASSACHUSETTS ATTORNEY GENERAL: This handgun is not equipped with a device that fully blocks use by unauthorized users. More than 200,000 firearms like this one are stolen from their owners every year in the United States. In addition, there are more than a thousand suicides each year by younger children and teenagers who get access to firearms. Hundreds more die from accidental discharge. It is likely that many more children sustain serious wounds, or inflict such wounds accidentally on others. In order to limit the chance of such misuse, it is imperative that you keep this weapon locked in a secure place and take other steps necessary to limit the possibility of theft or accident. Failure to take reasonable preventive steps may result in innocent lives being lost, and in some circumstances may result in your liability for these deaths.”

“IT IS UNLAWFUL TO STORE OR KEEP A FIREARM, RIFLE, SHOTGUN OR MACHINE GUN IN ANY PLACE UNLESS THAT WEAPON IS EQUIPPED WITH A TAMPER-RESISTANT SAFETY DEVICE OR IS STORED OR KEPT IN A SECURELY LOCKED CONTAINER.”

New Jersey:

“IT IS A CRIMINAL OFFENSE TO LEAVE A LOADED FIREARM WITHIN EASY ACCESS OF A MINOR.”

New York City:

“THE USE OF A LOCKING DEVICE OR SAFETY LOCK IS ONLY ONE ASPECT OF RESPONSIBLE FIREARM STORAGE. FOR INCREASED SAFETY, FIREARMS SHOULD BE STORED UNLOADED AND LOCKED IN A LOCATION THAT IS BOTH SEPARATE FROM THEIR AMMUNITION AND INACCESSIBLE TO CHILDREN AND OTHER UNAUTHORIZED PERSONS.”

North Carolina:

“IT IS UNLAWFUL TO STORE OR LEAVE A FIREARM THAT CAN BE DISCHARGED IN A MANNER THAT A REASONABLE PERSON SHOULD KNOW IS ACCESSIBLE TO A MINOR.”

Texas:

“IT IS UNLAWFUL TO STORE, TRANSPORT, OR ABANDON AN UNSECURED FIREARM IN A PLACE WHERE CHILDREN ARE LIKELY TO BE AND CAN OBTAIN ACCESS TO THE FIREARM.”

Wisconsin:

“IF YOU LEAVE A LOADED FIREARM WITHIN THE REACH OR EASY ACCESS OF A CHILD YOU MAY BE FINED OR IMPRISONED OR BOTH IF THE CHILD IMPROPERLY DISCHARGES, POSSESSES, OR EXHIBITS THE FIREARM.”

* * * * *

Please check with your licensed retailer or state police for additional warnings which may be required by local law or regulation. Such regulations change constantly, and local authorities are in the best position to advise you on such legal matters.

FIREARMS SAFETY IS YOUR RESPONSIBILITY
**SAFETY MUST BE THE FIRST AND CONSTANT
CONSIDERATION OF EVERY PERSON WHO HANDLES
FIREARMS AND AMMUNITION.**

This Instruction Manual is designed to assist you in learning how to use and care for your **RUGER® SR-SERIES** pistol properly. Please contact us if you have any questions.

Only when you are certain you fully understand the manual and can properly carry out its instructions should you practice loading, unloading, etc. with live ammunition. If you have any doubts about your ability to handle or use a particular type of gun safely, you should seek supervised instruction. Such personalized instruction often is available from local gun retailers, gun clubs or police departments. If none of these sources can help, visit www.nra.org or write to the following address:

National Rifle Association
11250 Waples Mill Road
Fairfax, VA 22030-7400

The person possessing a gun has a full-time job. You cannot guess; you cannot forget. You must know how to use your firearm safely. **Do not use any firearm without having a complete understanding of its particular characteristics and safe use.** Remember: There is no such thing as a foolproof gun.

TABLE OF CONTENTS

State-By-State Warnings	3
Nomenclature	8
Locking Device Installation Instructions	9
General Information and Mechanical Characteristics	11
Operation of Manual Safety	12
Striker Status Indicator	14
Ammunition	15
To Load and Fire	16
Operation of Loaded Chamber Indicator	18
Operation of Magazine Disconnect	19
Dry Firing	20
To Unload	20
Magazine Loader – SR9’s and SR40’s	22
Magazine Loader – SR45	23
To Reload The Pistol	23
To Extract and Eject a Chambered Cartridge	24
To Clear a Malfunction (“Jam”)	24
To Minimize Malfunctions (“Jams”)	25
To Disassemble	26
To Reassemble	29
Reversing the Backstrap	31
Magazine Inspection and Care	32
Care and Cleaning	33
Storage	34
Sight Adjustment	35
Service and Parts Policy	36
Shipping Firearms for Repair	36
Ordering Parts	38
SR9, SR40 & SR45 Parts List	39
SR9, SR40 & SR45 Exploded View	41
SR9c & SR40c Parts List	42
SR9c & SR40c Exploded View	44
9E™ Supplemental Parts List & Exploded View	45
The Basic Rules of Safe Firearms Handling	46
Warranty Information	52

“Ruger” is a registered U.S. trademark.

	WARNINGS OF GREAT IMPORTANCE ARE FOUND ON THE FOLLOWING PAGES:			
Locking Devices	9	Slide Retraction	21	
Alterations	11	Malfunctions	25	
Manual Safety	13	Disassembly	28	
Ammunition	15	Lubrication	34	
Lead Exposure	15	Storage	34	
Firing	17	Shipping	36	
Handling	19	Parts Purchasers	37	
Unloading	20			
OTHER CAUTIONS AND WARNINGS APPEAR THROUGHOUT THE MANUAL.				

NOMENCLATURE

Sights have high-visibility white dots both front and rear. Both sights can be adjusted for windage.

Slide's open-top design minimizes possibility of jamming, enables shooter to clear any malfunction easily by hand.

Elevation click-adjustable **rear sight** is drift adjustable for windage. (Does not apply to the 9E™ model.)



Frame is a rigid one-piece glass reinforced nylon.

Takedown pin.

Over-size **trigger guard** permits shooting with gloved hand.

Ambidextrous **magazine latch** permits positive retention and quick removal of magazine.

When ambidextrous **manual safety** is in "safe" position, locks the trigger and trigger bar.

Slide stop holds the slide open and is activated automatically when last shot is fired (if magazine is in pistol), or can be manually operated.

Magazine has **gripping grooves** on floorplate.

Ambidextrous **manual safety.**

Loaded Chamber Indicator protrudes from the top of the slide and provides a visual and tactile indication when a round is present in the firing chamber. (Does not apply to the 9E™ model. The 9E™ has a loaded chamber **View Port**.)



Unique **Reversible Backstrap** changes from flat to arched (shown) in seconds.

The **Magazine latch.**

The **Accessory Rail** accepts most lights and sighting devices designed to fit the M1913 Picatinny Standard Rail.

Trigger safety and **firing pin block** prevent firing unless trigger is completely pulled.

The **Magazine Disconnect** is designed to prevent the pistol from being fired when the magazine is removed, even if a live round remains in the firing chamber.

LOCKING DEVICE INSTALLATION INSTRUCTIONS



WARNING – USE OF LOCKING DEVICES



**Do not store keys
in lock.**

- Always keep your firearm pointed in a safe direction, including when you are installing or removing your locking device.
- Always verify that your firearm is completely **unloaded** (see pgs. 18 - 19) before installing your locking device.
- Do **not** install locking devices in the trigger guard; always keep your fingers and locking device outside the trigger guard during device installation and removal.
- Store firearms, ammunition and keys separately and securely, away from children and careless adults; do **not** store your firearm with the keys in the locking device.
- Do not attempt to work the action of your firearm with the locking device in place; this may damage your firearm.
- While locking devices are an important aid to security measures, they are not a substitute for safe firearm handling and proper storage. Remember that any mechanical device can be bypassed with enough time, knowledge, determination and equipment.

**LOCKING DEVICES MUST BE USED
SAFELY AND RESPONSIBLY**

It is important to use the locking device on your Ruger® firearm!

Keep the muzzle pointed in a safe direction and your fingers outside the trigger guard at all times!

To Install the Factory-Supplied Locking Device:

1. Remove the magazine from your pistol.
2. Open the action completely, and verify that the firearm is completely unloaded and contains no cartridges or cartridge cases!

Use the slide stop to keep the action open during installation of the locking device.

3. Insert the cable directly to your pistol as shown in Figure 1.
4. To lock: With the key turned to the farthest clockwise position, insert the loose end of the cable into the lock. Turn the key counterclockwise and remove the key.
5. Once the lock is securely closed, pull firmly on the cable to test the connection and be sure it is locked. **Do not leave or store your firearm with the key in the lock!** Store your locked unloaded firearm and the key in secure, separate locations, away from ammunition, children, and unauthorized adults.



Figure 1

Correct Installation of Cable Lock
For Ruger® SR-Series & 9E™ Pistols

**FIREARMS ARE DANGEROUS WEAPONS
READ THE INSTRUCTIONS AND WARNINGS
IN THIS MANUAL THOROUGHLY AND
CAREFULLY BEFORE USING.**

 WARNING - ALTERATIONS	
	This product was designed to function properly in its original condition. Alterations can make it unsafe. Do not alter any part or add or substitute parts or accessories not made by Sturm, Ruger & Co., Inc.
	DO NOT ALTER ANY GUN

GENERAL INFORMATION AND MECHANICAL CHARACTERISTICS

RUGER® SR-SERIES pistols are centerfire, striker-fired, magazine-fed, autoloading, recoil-operated pistols chambered for the 9mm Parabellum (SR9, SR9c, & 9E), 40 S&W (SR40 & SR40c) or 45 Auto (SR45) cartridges. **SR-SERIES** pistols incorporate a different “link-less” design in the barrel locking/unlocking system than earlier Ruger P-Series pistols, and features a streamlined slide and high performance glass-filled nylon grip frame. They have a unique, new modular construction in which the entire steel camblock assembly (which contains the barrel locking system, recoil absorption block, and steel slide rails) and trigger mechanism assembly can be inserted and removed as units. They include the following features with which users should be thoroughly familiar:

Action: The action of the Ruger **SR-SERIES** of pistols is of the improved striker-fired type that utilizes a tilting barrel design in which the barrel and slide are locked together at the moment of firing. The internal striker is partially cocked by the closing action of the slide. Pulling the trigger fully to the rear completes the cocking of the striker, releases the internal striker block, and disengages the internal trigger safety. The last bit of trigger pull fires the pistol. After firing, the barrel and slide recoil to the rear a short distance while still locked together. After this initial movement, the barrel is cammed downward from its locked position, permitting full recoil of the slide and the extraction and ejection of the spent cartridge case. Upon return of the slide to its forward position by the recoil spring, the barrel is cammed back upward into its locked position in the slide.

The user of this or any autoloading pistol must always remember that when fired, it automatically reloads and recocks itself, so that simply pulling the trigger will fire the pistol again. Therefore, an autoloading pistol user must be particularly conscious to always keep the pistol pointed in a safe direction.

Slide Stop: When the last shot has been fired and the magazine is empty, the slide stop automatically holds the slide open. When there is an empty magazine in the pistol and the slide is retracted manually, the slide stop will also automatically hold the slide open. If a loaded magazine is inserted in the pistol when the slide is closed and the slide is then retracted fully, the slide stop will not automatically hold open the slide. The user can actuate the slide stop mechanism to hold the slide open at any time by retracting the slide and pushing the slide stop up.

The slide stop can be released by drawing back slightly on the slide and depressing the slide stop thumbpiece. When the slide is released, it will move forward under pressure from the recoil spring.

The slide stop is spring loaded downward. Therefore, when there is a loaded magazine in place and the pistol is jarred, the slide can fly forward and chamber a cartridge. For this reason and as an essential safety practice, **the user should always be careful to keep fingers away from the trigger, keep the safety on, and always keep the pistol pointed in a safe direction.**

Magazines: The 17-rd and extended 10-rd 9mm Parabellum magazines designed for the SR9, SR9c, and 9E are interchangeable with each other, but are not interchangeable with other Ruger 9mm Parabellum magazines or Ruger pistol magazines of any other caliber even though they may appear similar. The 15-rd and extended 10-rd 40 S&W magazines designed for the SR40 and SR40c are interchangeable with each other, but are not interchangeable with other Ruger 40 S&W magazines or Ruger pistol magazines of any other caliber even though they may appear similar. The 45 Auto magazines are not interchangeable with Ruger pistol magazines of any other caliber even though they may appear similar. Use of incorrect magazines in any pistol will result in malfunctions.

OPERATION OF MANUAL SAFETY

The model you have selected is equipped with ambidextrous manual safety levers. To engage the manual safety, **point the pistol in a safe direction.** **NOTE:** The slide must be fully forward before the safety can be moved upwards. Move either the right- or left-hand safety lever upward and fully to the “safe” position. When the safety is moved fully upward to the “safe” position, the red oval on the left side of the slide will be fully covered by the left safety lever and a white dot will be visible. If any red is showing, the safety is not in the “safe” position. **Do not attempt to engage the safety while pulling the trigger.**

The safety mechanism provides that the trigger cannot be pulled unless the safety is disengaged. Like the 1911 pistols, the manual safety lever locks the slide shut, ensuring that the pistol will be ready to fire when the safety is disengaged. To disengage the manual safety, point the pistol in a safe direction and push either safety lever fully downward. The red oval signifies that the safety is disengaged and the pistol is ready to fire.

Additionally, the pistol has a separate internal striker block which will not allow the striker to move forward and contact the cartridge until the operator pulls the trigger with the safety off (in its “fire” position).

The safety should be in its “safe” position at all times except when the user is deliberately positioned to fire at a selected target. When the safety is in the “fire” position (safety lever down) the red oval is exposed just above the safety lever. See Figures 2 and 3, below, which illustrate the two positions of the safety.

“SAFE” POSITION



Figure 2

“FIRE” POSITION



Figure 3



WARNING - MANUAL SAFETY



Placing the safety in an intermediate position between “safe” and “fire” can result in the user thinking the pistol is in a safe or fire position when it is not. Pulling the trigger with the safety in an intermediate position may cause the pistol to fire. Therefore, always move the safety fully to its intended position and then check to be sure it is where you want it to be. Unless the red oval is fully covered by the safety lever, the safety is not “ON.” Unless the red oval is fully visible, the pistol is not absolutely ready to fire.

NEVER PUT SAFETY 1/2 ON

STRIKER STATUS INDICATOR

Your **SR-SERIES** pistol is equipped with a Striker Status Indicator. The back of the striker is visible when the action is semi-cocked. (See Figure 4.)

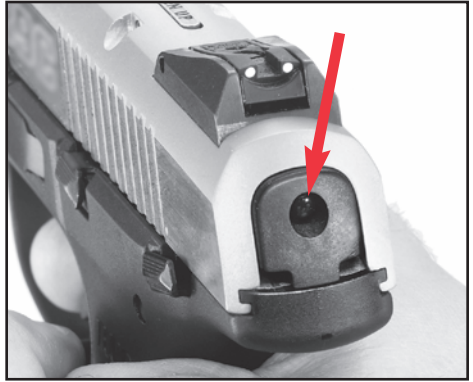

Figure 4

As the trigger is pulled, the striker can be seen moving backward. (See Figure 5.)



Figure 5

When the striker is released by the trigger, it disappears from view. (See Figure 6.)

Your **SR-SERIES** pistol also is equipped with an internal striker blocker that prevents the striker from contacting the primer of a cartridge in the chamber until the trigger is pulled. An additional trigger safety blocks trigger bar movement until the trigger is pulled. An internal trigger bar interlock prevents the trigger bar from moving down to release the striker until it is moved back by trigger movement.

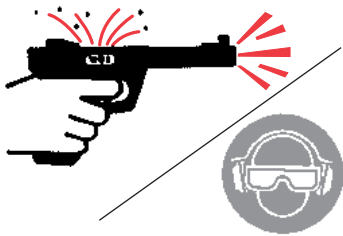

Figure 6

AMMUNITION



The **RUGER® SR-SERIES** pistols are chambered for the 9mm Parabellum (SR9, SR9c, & 9E), 40 S&W (SR40 & SR40c) or 45 Auto (SR45) cartridges. Do not attempt to load any other cartridges into the magazine or chamber of the pistol.

The **SR-SERIES** pistols are compatible with all factory ammunition of the correct caliber loaded to U.S. Industry Standards, including high-velocity and hollow-point loads, loaded in brass, aluminum, or steel cartridge cases. No 9mm Parabellum, 40 S&W or 45 Auto ammunition manufactured in accordance with NATO, U.S., SAAMI, or CIP standards is known to be beyond the design limits or known not to function in these pistols.

 WARNING – AMMUNITION	
	<p>Death, serious injury, and damage can result from the wrong ammunition, bore obstructions, powder overloads or incorrect cartridge components.</p> <p><u>Always</u> wear shooting glasses and hearing protection.</p>
IMPROPER AMMUNITION DESTROYS GUNS	

AMMUNITION (CARTRIDGES) NOTICE

WE SPECIFICALLY DISCLAIM RESPONSIBILITY FOR ANY DAMAGE OR INJURY WHATSOEVER OCCURRING IN CONNECTION WITH, OR AS A RESULT OF, THE USE IN RUGER FIREARMS OF FAULTY OR NON-STANDARD OR "RE-MANUFACTURED" OR HAND-LOADED (RELOADED) AMMUNITION, OR OF CARTRIDGES OTHER THAN THOSE FOR WHICH THE FIREARM WAS ORIGINALLY CHAMBERED.

 WARNING - LEAD EXPOSURE	
	<p>Discharging firearms in poorly ventilated areas, cleaning firearms, or handling ammunition may result in exposure to lead and other substances known to the State of California to cause birth defects, reproductive harm, and other serious physical injury. Have adequate ventilation at all times. Wash hands thoroughly after exposure.</p>
SHOOTING OR CLEANING GUNS MAY EXPOSE YOU TO LEAD	

TO LOAD AND FIRE

Practice this important aspect of safe gun handling with an unloaded pistol until you can perform each of the steps described below with skill and confidence. **But before you do anything with the pistol, first read completely through this manual.**

1. **Be certain the muzzle is pointed in a safe direction.** (See “The Basic Rules of Safe Firearms Handling,” page 46.)
2. Pull the slide fully to the rear until the slide stops, and lock it open. (See Figure 7.)
3. Press the magazine latch inward from either side and remove the magazine from the frame. **NOTE:** The magazine is designed to fall free of the frame of its own weight when unloaded, the slide is locked open and the pistol is held in the normal firing position. You should always prevent possible damage to the magazine by not letting it drop to the ground unless rapid reloading is absolutely necessary.
4. For the 10-rd magazines, place ten or fewer cartridges into the magazine from the top. For the 17-rd magazine, place seventeen or fewer cartridges in the magazine. For the 15-rd magazine, place fifteen or fewer cartridges in the magazine. The magazine has holes on the side to assist in counting the number of cartridges in the magazine. **NOTE:** When using the 17-round magazine in the **SR9c™**, use the Magazine Adapter to ensure reliable feeding.
5. Insert the magazine into the frame, taking care that the magazine is locked in place by the magazine latch. Slamming the magazine into the frame forcibly is not necessary.
6. Hold the pistol firmly in the shooting hand but **do not touch the trigger. Keep the pistol pointed in a safe direction.** With the thumb and forefinger of the other hand grasp the rear of the slide and pull the slide to the rear as far as it will go (see Figure 7, below and “Slide Retraction Warning”, p. 21). When released, the slide will fly forward to strip the top cartridge from the magazine and chamber it.

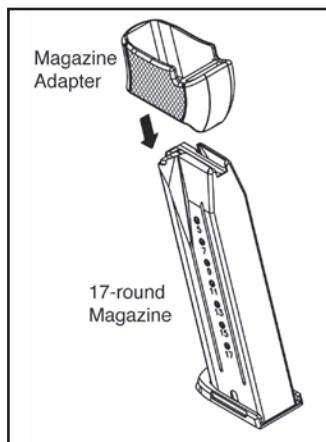



Figure 7
Retracting the Slide

- Engage the safety by moving the safety lever fully upward.

WARNING: The pistol is ready for instant use once the slide moves forward if the safety is in the “fire” position. Be careful!

- If the pistol is not to be fired immediately, the safety should be immediately placed into the fully upward “safe” position (see Figure 2, p. 13). If the pistol is to be fired immediately, the manual safety can remain downward to its “fire” position (see Figure 3, p. 13). The striker is still blocked at all times by the internal striker blocker and the trigger bar cannot move to complete cocking of the striker unless the trigger is pulled all the way to the rear to fire the pistol.
- The pistol is ready for instant use once the safety is disengaged. When the pistol is in the semi-cocked mode (See Figure 4, p. 13), the first shot can be fired by pulling the trigger all the way to the rear, which fully cocks the striker and then fires the pistol. Subsequent shots are fired until the magazine is empty, the striker being semi-cocked by the slide as it recoils from each shot.

 WARNING - FIRING	
	The slide automatically opens and shuts quickly while firing. Keep face and hands away from rear. Hot brass is ejected quickly and can burn you. Always shooting glasses and hearing protection.
SLIDE OPENS FAST - HOT BRASS EJECTED	

- Immediately following the firing of a shot, and if a subsequent shot is not to be fired at once, put the safety in its “safe” position (lever fully upward and red oval completely covered) while the pistol is still pointing in a safe direction downrange.
- When the last cartridge loaded into the pistol has been fired, the magazine follower presses the slide stop upward to engage the slide, automatically holding the action open. If the slide is shut, the shooter should always assume that there is a cartridge in the chamber!

Don't rely on your memory or the word of others to know if a gun or magazine is loaded. With the pistol pointed in a safe direction, visually inspect the magazine and chamber.

OPERATION OF LOADED CHAMBER INDICATOR

(Does Not Apply to the **RUGER® 9E™**)

You should always treat every gun as though it is loaded and always keep the muzzle pointed in a safe direction. Never rely upon any safety or mechanical device to justify unsafe or careless gun handling. In order to assist you in determining the presence of a cartridge in the chamber of your **RUGER® SR-SERIES** pistol, and to comply with state laws, the **SR-SERIES** is equipped with a loaded chamber indicator. The indicator appears on the top of the slide. (See “Nomenclature,” p. 8.)

When the chamber is empty, the loaded chamber indicator should be flush with the top of the slide. (See Figure 8a, below.)

When the chamber is loaded, the forward portion of the loaded chamber indicator should protrude from the top of the slide. When the chamber contains a cartridge, a red bar should be visible on either side of the loaded chamber indicator. (See Figure 8b, below.)

OPERATION OF LOADED CHAMBER INDICATOR

**Indicator
Flush
With Top**



Figure 8a

**Indicator
Protrudes
From
Top -
Red Bar
Visible**

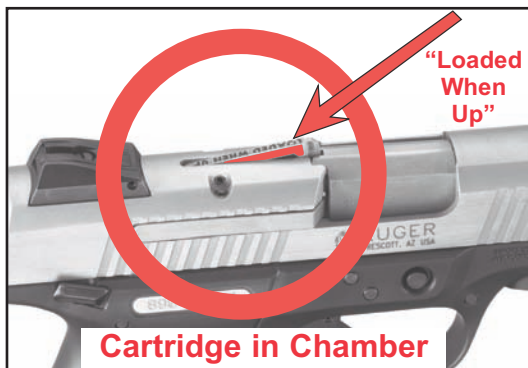

Figure 8b



NEVER RELY ON YOUR MEMORY OR ANY LOADED CHAMBER INDICATOR TO KNOW IF A GUN IS LOADED. ANY MECHANICAL DEVICE CAN FAIL. ALWAYS VISUALLY CHECK THE CHAMBER BY RETRACTING THE SLIDE AND EXAMINING THE CHAMBER TO BE SURE WHETHER IT IS EMPTY OR LOADED.

OPERATION OF MAGAZINE DISCONNECT

Your **RUGER® SR-SERIES** pistol is equipped with a magazine disconnect. This device prevents firing if the magazine is removed from the pistol. You will not be able to use your **SR-SERIES** pistol as a single loader (unless you place one cartridge in the magazine and insert it into the pistol) or to fire the pistol with the magazine out of the pistol.



REMEMBER THAT A ROUND MAY STILL BE IN THE CHAMBER AND THAT THE PISTOL MAY STILL BE LOADED EVEN IF THE MAGAZINE IS REMOVED. AS SOON AS AN EMPTY MAGAZINE IS INSERTED, A ROUND IN THE CHAMBER CAN BE FIRED BY PULLING THE TRIGGER.

BE CAREFUL! AS ALWAYS, YOU SHOULD NOT RELY UPON THE MAGAZINE DISCONNECT OR ANY OTHER MECHANICAL DEVICE OR SAFETY TO JUSTIFY CARELESS OR UNSAFE HANDLING OF ANY FIREARM.

Don't rely on your memory or the word of others to know if a gun or magazine is loaded. Visually inspect the magazine and the chamber to be certain.

WARNING - HANDLING

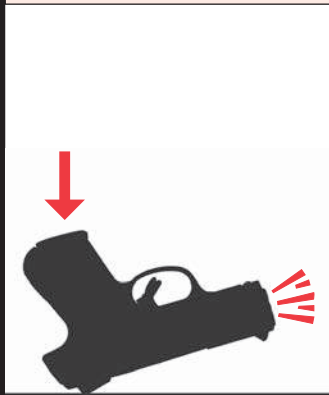

Do not load the pistol until you are ready to use it, and unload it immediately when you have completed shooting. (See "Warning - Unloading" on page 20.)

If dropped or struck, the pistol may fire. Keep chamber empty unless actually firing! Use the safety lever before moving with pistol or when not actually firing.

For maximum safety when carrying the pistol with a loaded magazine in place, the chamber should be empty, the slide should be closed, and the safety should be in the "ON" position. If placed into a holster, check it to be sure that the slide is not retracted far enough to chamber a cartridge from the magazine.

The user should never depend on any mechanical device to justify careless handling or permitting the pistol to point in an unsafe direction. The shooter should always be alert to the possibility of accidental discharge. **The only absolutely safe pistol is one in which the slide is open, the chamber is empty, and there is no magazine in the gun.**

ANY GUN MAY FIRE IF DROPPED

DRY FIRING

Going through the actions of cocking, aiming and pulling the trigger on an unloaded gun is known as “dry firing.” It can be useful to learn the “feel” of your pistol. Be certain that the pistol is fully unloaded (both the chamber and magazine are empty) and that the pistol is pointing in a safe direction even when you are practicing dry firing. The **RUGER® SR-SERIES** pistols can be dry-fired without damage to the striker or other components as long as an empty magazine is inserted.



CAUTION: Dry firing your **RUGER® SR-SERIES** with the magazine removed may result in damage or unnecessary wear to the magazine disconnect mechanism and/or striker.

NOTE: When dry firing the **SR-SERIES** pistols, the trigger will not automatically move forward to reset. The slide must be retracted at least 1/2” to reset the trigger and firing mechanism.

TO UNLOAD

WARNING: This sequence must be followed exactly as outlined. Failure to do so can result in the chamber being unintentionally loaded with a live cartridge!

1. The muzzle of the pistol must be pointing in a safe direction at all times, and fingers should be outside of the trigger guard.
2. Remove the magazine from the pistol by pushing in on the magazine latch. **REMEMBER** that even though the magazine has been removed, a live round may remain in the chamber. (See “Warning - Unloading,” below.)
3. Hold the pistol firmly and grasp the slide. Retract the slide to its rearmost position briskly to extract and eject any chambered cartridge. Always double check visually that the chamber, breech-face, and the interior of the frame are clear of any live rounds. When the slide is fully retracted, push upward on the slide stop, then allow the slide to move forward until it comes to rest with the rear projection of the slide stop resting in the notch on the lower left side of the slide.

 WARNING - UNLOADING	
	Removing magazine does not unload pistol! To unload, first remove magazine, then pull slide to rear, eject chambered cartridge, and visually inspect chamber to be sure it is empty. Always point the pistol in a safe direction when loading or unloading.
	Removing the magazine should prevent the pistol from firing – but never rely on this as any other mechanical safety device to justify careless handling of any firearm.
REMOVING MAGAZINE DOES NOT UNLOAD CHAMBER	

CORRECT UNLOADING SEQUENCE

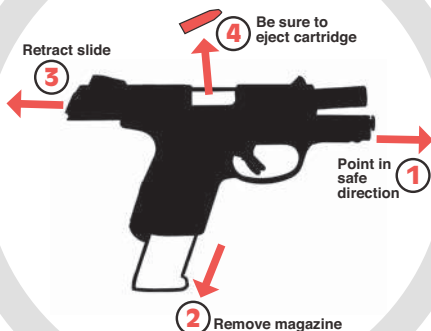

WARNING - SLIDE RETRACTION

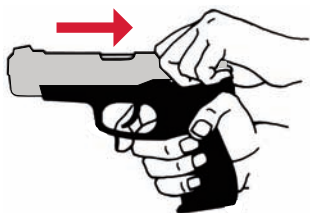

The slide should always be pulled rearward (“retracted”) by pulling the rear portion of the slide in the vicinity of the serrations. **Always keep fingers away from trigger!**

Never put any part of your hands or body over the muzzle while retracting the slide for loading, unloading, inspection, or clearing a malfunction.

KEEP HANDS AWAY FROM MUZZLE AND FINGER OFF TRIGGER

4. To close the slide, **again check to be sure the chamber and breech-face are empty.** Pull the slide to its rearmost position and release it. The slide will snap forward. Keep fingers out of ejection port on top of slide!
5. If the magazine contains cartridges, they can be removed by sliding each cartridge forward and out of magazine, one at a time, until the magazine is empty.
6. Push the empty (unloaded) magazine into frame until the magazine latch locks it in place. **Remember that doing so deactivates the magazine disconnect and a cartridge left in the chamber will now fire if the trigger is pulled. Be careful!**

MAGAZINE LOADER INSTRUCTIONS (For SR9's and SR40's)

SR9 and **SR40** pistols are shipped with a Magazine Loading Tool (Part No. VS06010). The operation of the magazine loader is as follows:

1. Insert the first cartridge in the magazine in the normal manner.
2. Place the magazine loader over the top of the magazine with the curved arm at the rear. (See Figure 9.)
3. Place the base of the magazine on a working surface, then apply downward pressure on the magazine loader, far enough to allow you to insert the next cartridge just under the lips of the magazine. (See Figure 10.)
4. Pull the magazine loader up and then push the top cartridge to the rear of the magazine. (See Figure 11.)
5. Repeat steps 3 and 4 until the magazine is fully loaded.

Figure 9



Figure 10

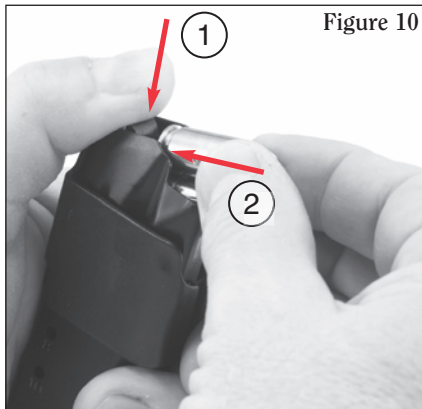
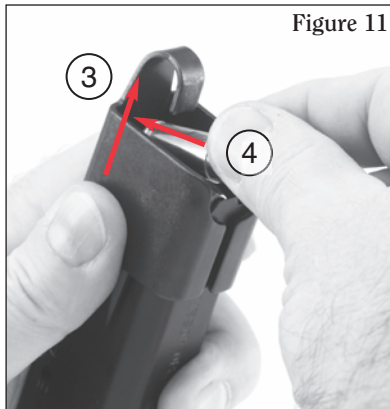

Figure 11



MAGAZINE LOADER INSTRUCTIONS

(For SR45)

The **SR45™** pistol is shipped with a Magazine Loading Tool (Part No. VS06045). The operation of the magazine loader is as follows:

1. Insert the first cartridge in the magazine in the normal manner.
2. Place the magazine loader over the top of the magazine with the arm resting on the loaded cartridge. (See Figure 12.)
3. Apply downward pressure on the thumb tab of the magazine loader until it stops (the arm will catch the forward edge of the magazine) and insert the next cartridge into the magazine. (See Figure 13.)
4. To remove the magazine loader, push up on the thumb tab and lift the magazine loader clear of the magazine. (See Figure 14.)
5. Repeat steps 3 and 4 until the desired number of rounds have been loaded into the magazine.

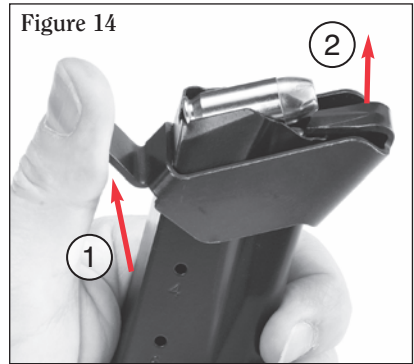
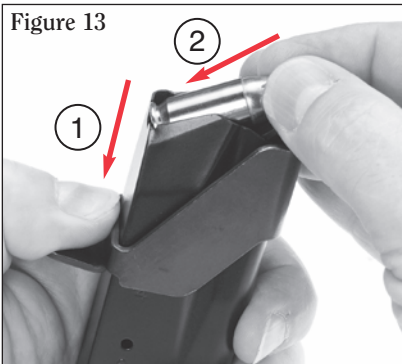
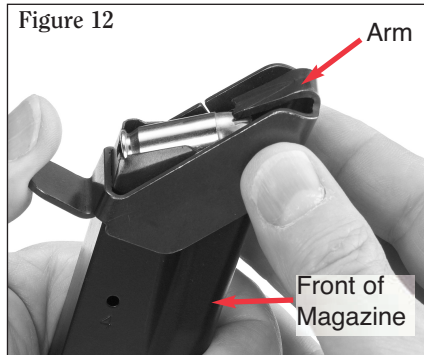

TO RELOAD THE PISTOL

1. Firing all cartridges in the magazine and the chamber will cause the slide to automatically lock open. **Keep the pistol pointed in a safe direction.** Press in on either magazine latch with the thumb or forefinger. The magazine will fall free of the pistol of its own weight if the slide is locked open. To avoid the possibility of damage to the magazine, do not let it fall to the ground unless rapid reloading is absolutely necessary.
2. Insert a loaded magazine. **WARNING: The slide stop is held in place by the slide pressing against the rear of the slide stop. Therefore, when there is a loaded magazine in place and the pistol is jarred, the slide can fly forward and chamber a cartridge. For this reason and as an essential safety practice, the pistol should always be pointed in a safe direction.**

3. Release the slide to move forward by pulling the slide fully to the rear and release it. A cartridge will be chambered when the slide shuts. **WARNING: The pistol is ready to fire. If you are not going to immediately shoot the pistol, engage the safety by moving the safety lever upward so that the red oval is fully covered and the white dot is exposed.** When you are finished firing the pistol, unload it completely (see pages 20 - 22).

TO EXTRACT AND EJECT A CHAMBERED CARTRIDGE

When the pistol is fired, the same gas pressure that drives the bullet forward also acts through the cartridge case to push the slide to the rear. The action causes extraction and ejection of the fired cartridge case. If a cartridge fails to fire or if the shooter wishes to eject the chambered cartridge manually, follow the procedure “To Unload,” p. 20. When the slide is operated by hand, there can be a failure to extract the cartridge from the chamber, or a failure to eject the cartridge clear of the pistol. These failures usually are the result of the slide not being pulled rearward vigorously.

The gun user must:

1. Always visually check the chamber and the breech-face after opening the slide to eject a chambered cartridge. If the slide is not vigorously retracted when being operated by hand, the extracted cartridge can be “ejected” into the magazine-well of the grip frame or remain held to the breech-face by the extractor.
2. Thoroughly clean the chamber and the extractor as often as necessary.

If an empty magazine is in the pistol when the slide is being hand retracted to extract a cartridge, the cartridge may drop on top of the magazine or remain held to the breech-face by the extractor. Then when the slide goes forward, the cartridge will be chambered again! **Remember — always remove the magazine before clearing the chamber, and visually ensure that no cartridges remain anywhere in the gun.**

TO CLEAR A MALFUNCTION (“JAM”)

1. **Be certain the muzzle is continually pointed in a safe direction.**
2. If possible, remove the magazine. It may be necessary to manually remove a jammed cartridge that has only been partially stripped from the magazine. If so, use extreme care. Lock the slide open with the slide stop before attempting to clear the jam. Drawing the slide fully to the rear may bring the jammed cartridge along. **Keep your face away from the ejection port during this operation.** When attempting to clear a jam, use only wood “tools” so that the cartridge will not be damaged or the primer ignited. A 3/16” wooden dowel with a point on one end is useful. Carefully remove the jammed cartridge from the chamber and dispose of it properly.
3. Visually check to make sure that all cartridges have been removed from the pistol. Safely dispose of any cartridges involved in a malfunction incident. Do not use damaged ammunition in any firearm.



WARNING - MALFUNCTIONS



Any autoloading pistol may occasionally malfunction. If a cartridge hangs up, jams, or binds when being chambered, do not attempt to force it into the chamber by pushing or striking the slide. Carefully remove it.

Most failures of a cartridge to feed or to chamber properly are caused by a damaged magazine, incorrect gun handling, insufficient lubrication, or improper ammunition.

Whatever the cause, the user of the pistol must, above all, recognize that any cartridge jam can result in a potentially very dangerous situation of a cartridge discharging before it is properly chambered. If this happens, the cartridge case may rupture and its fragments fly out of the ejection port of the pistol with sufficient force to cause serious injury. **Always wear shooting glasses!**



**HITTING PRIMER
CAN BURST CARTRIDGE**

TO MINIMIZE MALFUNCTIONS (“JAMS”)

1. If it appears that the jam was caused by the type of ammunition being used, try another brand, type, or lot number. Remember — use only factory ammunition of the correct caliber.
2. If changing ammunition does not at once eliminate malfunctions, then the following steps should be taken:
 - a. Thoroughly clean the pistol, paying particular attention to the removal of accumulated grease and dirt. Use a bristle brush and solvent to remove grease and fouling from the breech-face, extractor, chamber, and feed ramp area immediately behind the chamber.
 - b. Check to be sure that the magazine spring firmly returns the magazine follower to the top of the magazine.
 - c. Check the magazine lips to be certain that they are free of nicks and burrs and that they are not deformed or cracked.
 - d. Remove excess oil and solvent from all cleaned components, load the magazine, and try the pistol again. Make sure you are following the correct loading and firing sequence as described in this manual.
 - e. If none of the above steps is effective, try a different magazine of Ruger manufacture. If a new magazine does not function correctly, return the pistol and magazines to the Ruger Customer Service Department. (See “Shipping Firearms For Repair” on page 36.)
 - f. **Alterations to the pistol or use of non-Ruger magazines and accessories may cause malfunctions. See “Warning - Alterations” on page 11.**

TO DISASSEMBLE

Be sure pistol is unloaded!

An on-line video demonstrating the disassembly and reassembly of the SR-Series pistols can be viewed by going to www.ruger.com/resources/videos and then “Ruger Tech Tips.”

1. **Keep pistol pointed in a safe direction.** Press down on the magazine latch and remove the magazine. (See Figure 15.)

NOTE: Trigger should be in the forward position in order to disassemble the pistol.



Figure 15

2. Pull the slide to the rear and lock into the open position by pressing upward on rear of the slide stop. (See Figure 16.) **Again, be sure chamber is empty!**



Figure 16

3. Keep upward pressure on the slide stop to prevent forward movement of slide. The open slide is under strong spring tension and could injure fingers if allowed to slam shut. Insert finger (or another non-metallic object such as the eraser end of a pencil) through the top of the slide and push the ejector downward and forward until it locks in its forward position. (See Figure 17.) This will permit forward movement of the slide off the front of the frame.

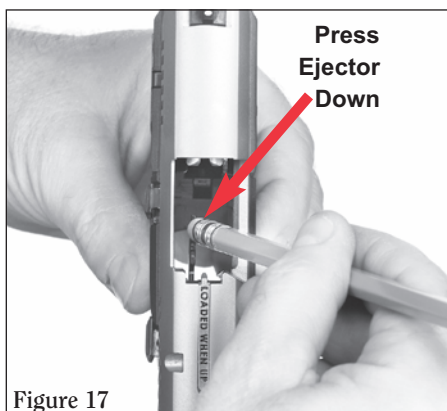
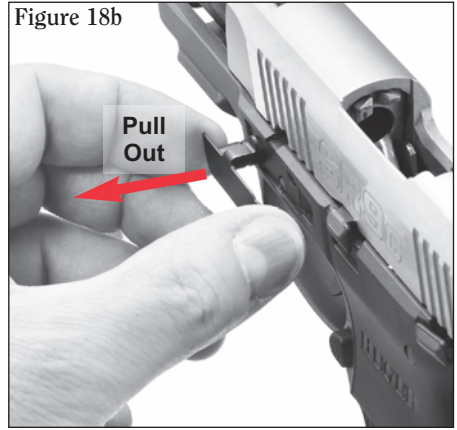

Figure 17

Further disassembly is impossible unless this is done.

4. Remove fingers (or whatever you used to push the ejector forward) from ejection port. From the right side of the pistol, press inward on the takedown pin (see Figure 18a) and remove it from the pistol (see Figure 18b).



5. Carefully allow the slide to move forward until it is no longer under spring tension. Now push the slide forward and remove the entire slide assembly from the frame. (See Figure 19.)

6. With the slide held upside down, slightly depress the recoil spring to disengage it from its seat against the barrel lug. (See Figure 20.) Lift the recoil spring forward and upward to remove it from the slide.

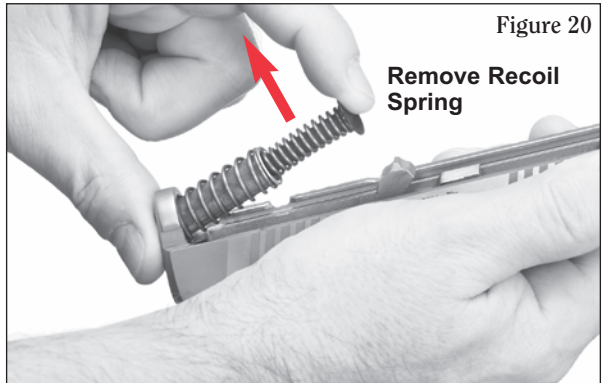

- 7. Move the barrel slightly forward to disengage it from the slide. Lift the barrel up and out of the slide. (See Figure 21.) Your pistol is now field stripped and ready for cleaning.

There is normally no need for further disassembly of the pistol.

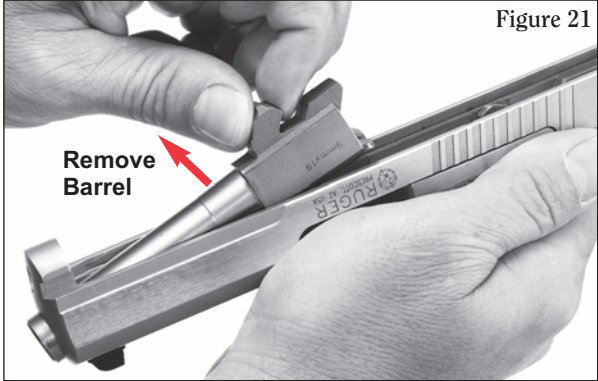



Figure 21

Figure 22



 WARNING - DISASSEMBLY	
	<p style="color: red;">Always unload a firearm before cleaning, lubrication, disassembly or assembly.</p>
UNLOAD BEFORE DISASSEMBLY	

TO REASSEMBLE

1. Be certain the chamber and magazine are empty. Always keep the pistol pointed in a safe direction.

2. With the slide held upside down, replace the barrel and push it rearward into its locked position. (See Figure 23.)

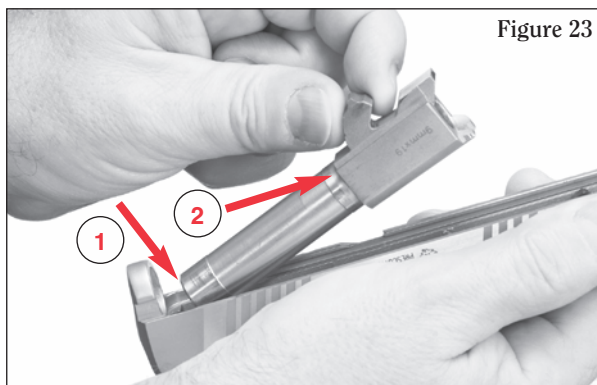

3. Place the recoil spring assembly into position. Make sure that the plastic end of the recoil spring goes into the slide. (See Figure 24.)

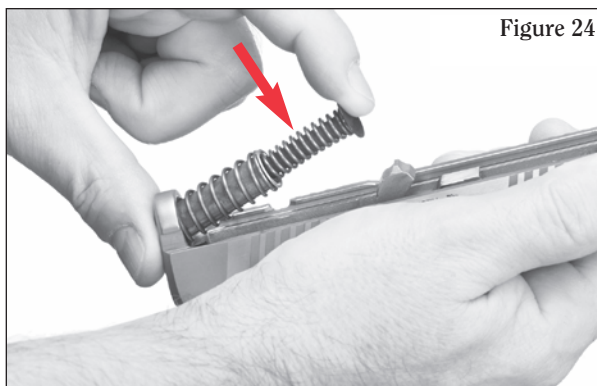

4. Be certain that ejector is pulled down and locked in its lower (forward) position. Push the trigger into its fully forward position. (See Figure 25.)

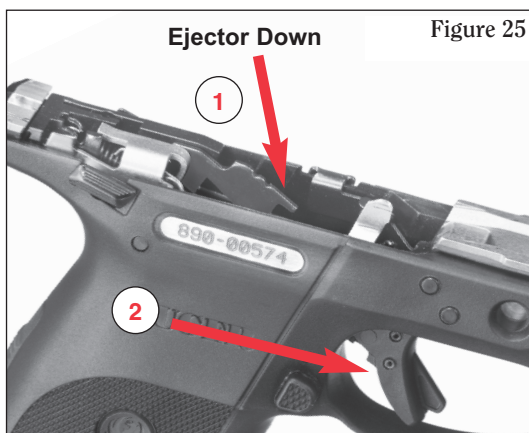

5. Replace the slide onto frame. Pull the slide fully back and lock it into position by pushing upward on the slide stop. (See Figure 26.)

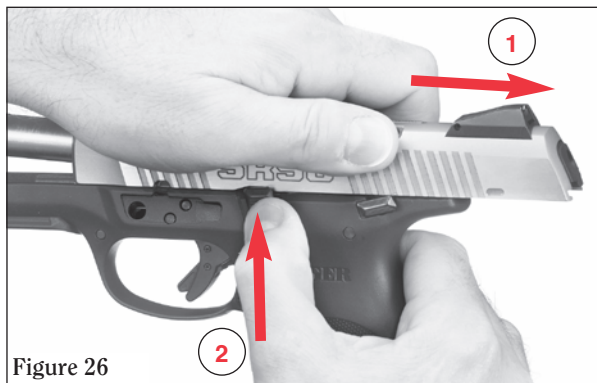

6. Now push the takedown pin all the way through the frame to the right. (See Figure 27.)
7. Allow the slide to move fully forward by retracting the slide and allowing it to move forward. (See Figure 28.)
8. Replace the empty magazine in frame through butt of pistol. (See Figure 29.) This action returns the ejector to its working position. This pistol will not function normally unless the ejector is in its Upward (rearward) position.

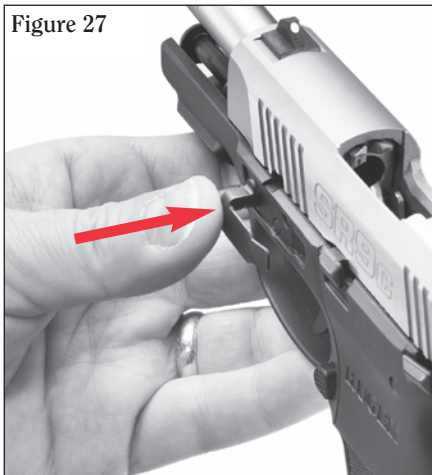

REVERSING THE BACKSTRAP

To accommodate personal grip preferences and styles, the **SR-SERIES** is equipped with a unique reversible backstrap. One side provides an arched surface; the reverse side is flat.

1. To reverse the backstrap, begin by removing the backstrap retaining pin using a correctly sized Allen wrench or large paper clip (shown here). Simply push the pin and set it aside. (See Figure 30.)



2. Slide the backstrap down and out of the grip frame. (See Figure 31a.)

NOTE: The full size **SR9** and **SR40**, **SR45** and **9E** have a backstrap bushing which must remain in the correct position during assembly. (See Figure 31b.)



3. Now reverse the backstrap (see Figure 32a), slide it back into the grip frame (Figure 32b) and reinsert the pin. Be careful to push the pin in far enough so that it is centered in the grip frame.

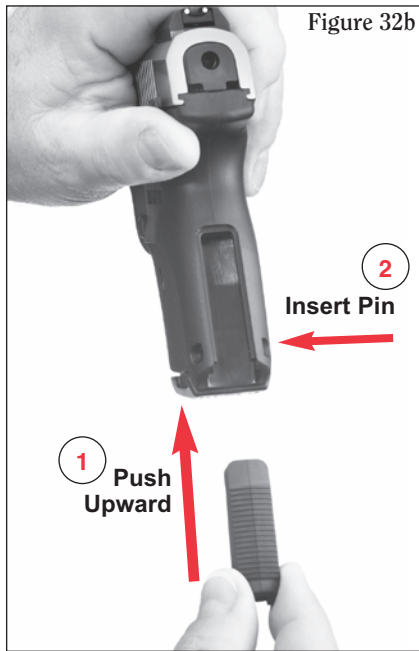

MAGAZINE INSPECTION AND CARE

Check the magazine frequently. The magazine follower must move freely and have adequate tension so that each cartridge is quickly raised to the feeding position. The magazine lips should be clean and free of cracks, dents, or nicks, so that cartridges are held in their proper feeding position.

If the magazine becomes dirty, it should be disassembled and thoroughly cleaned. **Be sure the magazine is unloaded before disassembly.** All **RUGER® SR-SERIES** magazines are manufactured with a snap-on base. The following disassembly instructions apply:

Snap-On Base - Use a punch to press in on the magazine spring seat where it protrudes into the hole in the magazine floorplate. Slide the magazine floorplate toward the front of the magazine, **be careful to prevent the forcible ejection of the magazine spring seat and compressed magazine spring.** Withdraw the magazine spring seat, magazine spring, and magazine follower from the magazine body. Reassemble in reverse order.

When cleaning is necessary, use a solvent that will not rust the metal components or adversely affect the magazine body. After the magazine has been soaked to loosen foreign matter, be certain to shake it vigorously (with the loading opening away from you) to remove solvent or residue from within the magazine.

Penetrating oils and solvents inside a magazine can “kill” or weaken cartridge primers or powder which can result in failures to fire or other possibly dangerous malfunctions, such as leaving a bullet in the bore!

After cleaning, always check to be certain that the magazine follower movement and tension are correct, and that no solvent or debris remain. Improper reassembly of the magazine can cause failure to feed, which is a potentially dangerous malfunction. If cleaning does not restore proper tension, or if you experience a problem with the magazine, don't use it. Get a new one.

DAMAGED, NON-STANDARD, OR IMPROPERLY ASSEMBLED MAGAZINES SHOULD NOT BE USED. THEY CAN CAUSE THE PISTOL TO MALFUNCTION.

CARE AND CLEANING

Make Sure Gun Is Unloaded!

BEFORE CLEANING, BE CERTAIN THE PISTOL AND ITS MAGAZINE ARE UNLOADED. (See “Warning - Unloading,” p. 20.) **KEEP THE PISTOL POINTED IN A SAFE DIRECTION.**

At regular intervals, or whenever the pistol has been exposed to sand, dust, extreme humidity, condensation, immersion in water, or other adverse conditions, disassemble, clean, and oil it. Proper periodic maintenance is essential to the reliable functioning of any firearm.

An on-line video demonstrating the proper cleaning procedure of the SR-Series pistols can be viewed by going to www.ruger.com/resources/videos and then “Ruger Tech Tips.”

To clean the pistol, proceed as follows:

1. Disassemble (fieldstrip) the pistol to the extent described on pages 26 - 28.
2. Using a cleaning rod, run a properly sized solvent-wetted patch through the bore several times. Then attach a solvent-wetted bristle brush to a cleaning rod and run it back and forth the full length of the bore as many times as necessary to remove grease and dirt from the bore and chamber. Clean bore with dry patches and examine. Bore fouling can contribute to reduced accuracy, and grease accumulation in the chamber can interfere with proper feeding of cartridges from the magazine.
3. Using powder solvent on a clean patch or bristle brush, remove powder residue from all components of the pistol. After cleaning, run a dry patch through the bore, then follow with a patch that is very lightly oiled. Wipe all surfaces clean with cloth, then wipe all surfaces with a patch or cloth that has been very lightly oiled.
4. **NOTE:** Only a light application of oil is needed to provide adequate lubrication of moving parts and to prevent rust. Excess accumulations of oil tend to attract particles of dust and dirt and may congeal in cold weather, which can interfere with the safe and reliable function of the pistol.
5. Before firing, remove all oil and grease from the bore.

! WARNING - LUBRICATION	
	<p>Firing a pistol with oil, grease, or any other material even partially obstructing the bore may result in damage to the pistol and serious injury to the shooter and those nearby. Do not spray or apply lubricants directly on ammunition. If the powder of a cartridge is affected by the lubricant, it may not be ignited, but the primer firing may push the bullet into the bore where it may be lodged. Firing a subsequent bullet into the obstructed bore may damage the pistol and cause serious injury or death to the shooter and those nearby. Use lubricants properly. You are responsible for the proper care and maintenance of your firearms.</p>
IMPROPER LUBRICATION DESTROYS GUNS	

STORAGE

GUNS SHOULD NOT BE STORED LOADED!

USE THE LOCKING DEVICE SUPPLIED WITH THE PISTOL TO RENDER IT INOPERATIVE FOR SAFE STORAGE.

(SEE PAGE 9)

Do not keep your pistol in a leather, fabric or canvas holster when it is stored. These materials attract moisture, even though the holster may appear to be perfectly dry.

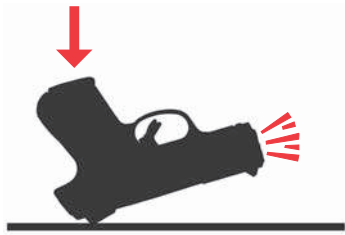
! WARNING - STORAGE	
	<ul style="list-style-type: none"> • Never place or store any firearm in such a manner that it may be dislodged. Firearms should always be stored securely and unloaded, away from children and careless adults. • Use the locking device supplied with the pistol for storage. The use of a locking device or safety lock is only one aspect of responsible firearms storage. • For increased safety, firearms should be stored unloaded in a location that is both separate from their ammunition and inaccessible to children and any other unauthorized person.
STORE SECURELY & UNLOADED	

SIGHT ADJUSTMENT

(Does Not Apply to the **RUGER® 9E™**)

RUGER® SR-SERIES pistols are equipped with a rear sight which is adjustable for both windage and elevation.

To adjust for elevation, rotate the screw in the rear sight clockwise or counter-clockwise to lower or raise the sight, respectively. (See Figure 33.) Note that lowering the rear sight will lower the point of impact, and raising the rear sight will raise the point of impact.

To adjust for windage, after the rear-sight lock screw has been loosened using a 5/64" Allen wrench, the rear sight can be drifted laterally in its dovetail on the top of the slide by tapping it with a wooden- or plastic-headed hammer or similar implement. Move the rear sight in the direction you want the shot to move on the target. After the rear sight is adjusted, tighten the rear-sight lock screw. Both front and rear sights are provided with white-dot inserts for rapid target acquisition and easy alignment of the sights to obtain a correct sight picture.



**REAR SIGHT
ELEVATION ADJUSTMENT**

SERVICE AND PARTS POLICY

If you have any questions with regard to the performance of your **RUGER® SR-SERIES** pistol, please write or call (928-541-8892) our Customer Service Department in Prescott, Arizona, fully describing all circumstances and conditions involved. If you should return your pistol to the factory for repair, or order parts for it, please comply with the following suggestions for prompt service:



WARNING—BEFORE SHIPPING ANY FIREARM, BE ABSOLUTELY CERTAIN THAT IT AND ITS MAGAZINE ARE UNLOADED. DO NOT SHIP CARTRIDGES WITH A FIREARM.

SHIPPING FIREARMS FOR REPAIR:

RUGER® SR-SERIES of pistols returned to the factory for service or repair should be sent to: Sturm, Ruger & Company, Inc., Customer Service Department, 200 Ruger Road, Prescott, AZ 86301-6181. **NOTE:** You must obtain a Repair Authorization Number before returning your firearm. An authorization number can be obtained by contacting Customer Service online at www.ruger.com or calling the Customer Service Dept. at 928-541-8892. Guns should be sent prepaid. We will not accept collect shipments.

The Federal Gun Control Act, as well as the laws of most states and localities, do not prohibit an individual (who is not otherwise barred from purchasing or possessing a firearm) from shipping a firearm directly to the manufacturer for repair. However, before you ship your pistol to us, be certain that your state or locality does not have a law or regulation which will prohibit you from receiving the pistol from us after it has been repaired. If such receiving is prohibited, then please have a Federally Licensed Firearms Dealer ship the gun to us. If your pistol is sent to us by a dealer, it will be returned to that dealer after being repaired. If a handgun (pistol or revolver) is shipped by an individual who does not hold a Federal Firearms License, it must be shipped for overnight delivery via U.P.S., Federal Express or other, similar private overnight service. **NOTE:** Handguns may not be shipped via U.S. Mail. Persons who do not hold a Federal Firearms License are prohibited by Federal law from shipping a handgun by Mail. Handguns mailed in violation of the law are impounded by the Post Office.

Please do not include holsters, custom grip panels, or accessories with a firearm being shipped to the factory for service. **DO NOT SEND GUN BOXES OR LITERATURE THAT YOU CONSIDER TO BE COLLECTOR'S ITEMS – THESE ARE INVARIABLY DAMAGED OR DESTROYED IN SHIPMENT.** Always insure your shipment.

Enclose a letter which includes your name, address, telephone number, serial number, model of the firearm, and your repair authorization number. Describe in detail the trouble you have experienced with your firearm, or the work you wish to have done. Merely stating that the firearm “needs repair” is inadequate information. Please enclose copies of any previous correspondence.

All work performed is subject to a minimum labor charge and charges for shipping and handling. Most models can be reblued, but custom gunsmithing service or nonstandard alterations are **NOT AVAILABLE** from Ruger Customer Service Departments. Please contact the Customer Service Department for pricing information.

 WARNING – PARTS PURCHASERS	
	<ul style="list-style-type: none">• It is the purchaser's responsibility to be absolutely certain that any parts ordered from the factory are correctly fitted and installed.• Firearms are complicated mechanisms and IMPROPER FITTING OF PARTS MAY RESULT IN A DANGEROUS MALFUNCTION, DAMAGE TO THE FIREARM, AND SERIOUS INJURY TO THE SHOOTER AND OTHER PERSONS.• The purchaser and installer of parts must accept full responsibility for the correct adjustment and functioning of the firearm after such installation.
PARTS MUST FIT CORRECTLY	

ORDERING PARTS

Please contact our Prescott, Arizona Customer Service Department for parts availability and current prices. All parts orders for **RUGER® SR-SERIES** of pistols should be sent to: Sturm, Ruger & Company, Inc., Parts Department, 200 Ruger Road, Prescott AZ 86301-6181, (928) 541-8892. We cannot comply with open account or C.O.D. requests. Payment in full via credit card (Visa, MasterCard or Discovery only), money order or certified bank check (no personal checks or cash, please) is required before any service will be performed. Please provide your credit card number, your name as it appears on the credit card, the expiration date, and the 3-digit security code. All parts orders are subject to a minimum charge and charges for shipping and handling. Order parts by ***Part Name and specify the model and entire serial number*** of the firearm for which the parts are being ordered. There is a minimum labor charge plus a shipping and handling charge if the parts are factory fitted. All factory fitted parts are fit on an exchange basis only. We will not return the replaced parts. Please contact the Customer Service Department for pricing information.

Because it is a serial numbered component, the **RUGER® SR-SERIES** frame is defined as a "firearm" by Federal law and is not sold as a separate component.

*Parts designated by an asterisk must be factory fitted. These parts are fitted on an exchange basis only. We will not return the replaced parts. We will not return any part that is broken, malfunctioning, badly worn or has been modified. See "Warning - Parts Purchasers," p. 37.



WARNING: A gun containing broken, malfunctioning or badly worn parts should not be fired!

RUGER® SR9® PRODUCT SAFETY WARNING AND RECALL NOTICE

We have determined that some Ruger SR9 pistols manufactured between October 2007 and April 2008 can, under certain conditions, fire if dropped with their manual safeties in the "off" or "fire" position. The pistols will not fire if the manual safety is in the "on" or "safe" position.

We will retrofit all Ruger SR9 pistols starting with serial number prefix "330" (330-xxxx) with the new trigger group **at no charge** to our customers.

In order to ensure correct fitting, the new parts must be installed at our Ruger factory in Prescott, Arizona. We will remove the old parts and install the new trigger group promptly, at no charge, and will return the pistol to you. The old parts will not be returned.

Please contact us by going online at www.ruger.com/SR9Recall/; e-mail at SR9Recall@ruiger.com; fax (928) 541-8873; or by calling our Prescott Product Service Department at (928) 541-8892.

RUGER® SR9®, SR40® & SR45™

PARTS LIST

Design, prices and specifications subject to change without notice.

SPECIFY MODEL, CALIBER, AND SERIAL NO. WHEN ORDERING

(See Exploded View on Page 41)

Key No.	Part Name
* 1	Slide
2	Front Sight
3	Loaded Chamber Indicator
4	Loaded Chamber Indicator Spring
5	Loaded Chamber Indicator Pin
6	Extractor Pivot Pin
7	Extractor
8	Extractor Spring
9	Rear Sight Elevation Screw
10	Rear Sight Leaf
11	Rear Sight Pivot Pin
12	Rear Sight Base
13	Rear Sight Elevation Spring
14	Rear Sight Lock Screw
* 15	Barrel
16	Striker Blocker Spring
17	Striker Blocker
18	Magazine Disconnect
19	Striker Cover Spring
20	Striker Cover Plunger
21	Striker Cover
22	Striker
23	Striker Cross Pin
24	Striker Spring
25	Striker Spring Cup
26	Striker Shaft
27	Guide Rod Assembly
28	Camblock
29	Trigger Pivot Pin
30	Camblock Pin, Front Retainer
31	Camblock Pin Retainer
32	Magazine Disconnect Spring
33	Slide Stop Lever Assembly
34	Trigger, Inner
35	Trigger, Inner Spring
36	Trigger, Outer
37	Trigger Outer Pin, 2 Req'd
38	Magazine Latch Spring
39	Magazine Latch
* 40	Trigger Bar
41	Trigger Bar Spring
42	Ejector

* PARTS SO MARKED MUST BE FACTORY FIT

Key No.	Part Name
43	Trigger Bar Lift Spring
44	Trigger Bar Reset
45	Trigger Bar Spring Mounting Pin
46	Thumb Safety Assembly
47	Ejector Pivot Pin
48	Safety Detent Plunger
49	Safety Detent Spring
50	Camblock Pin, Front
51	Takedown Pin Assembly
52	Camblock Pin, Lower
53	Camblock Pin, Upper
54	Magazine Latch Pivot Pin
55	Magazine Latch Thumbpiece
56	Fire Control Housing Pin
57	Backstrap Pin
58	Backstrap Insert
59	Backstrap Bushing
60	Magazine Loading Tool
61	Magazine - 17-round
62	Magazine - 10-round
63	Magazine - 15-round
64	Fire Control Housing

Also Available, but Not Illustrated
Case Only

* PARTS SO MARKED MUST BE FACTORY FIT

RUGER® SR9®, SR40® & SR45™

EXPLODED VIEW

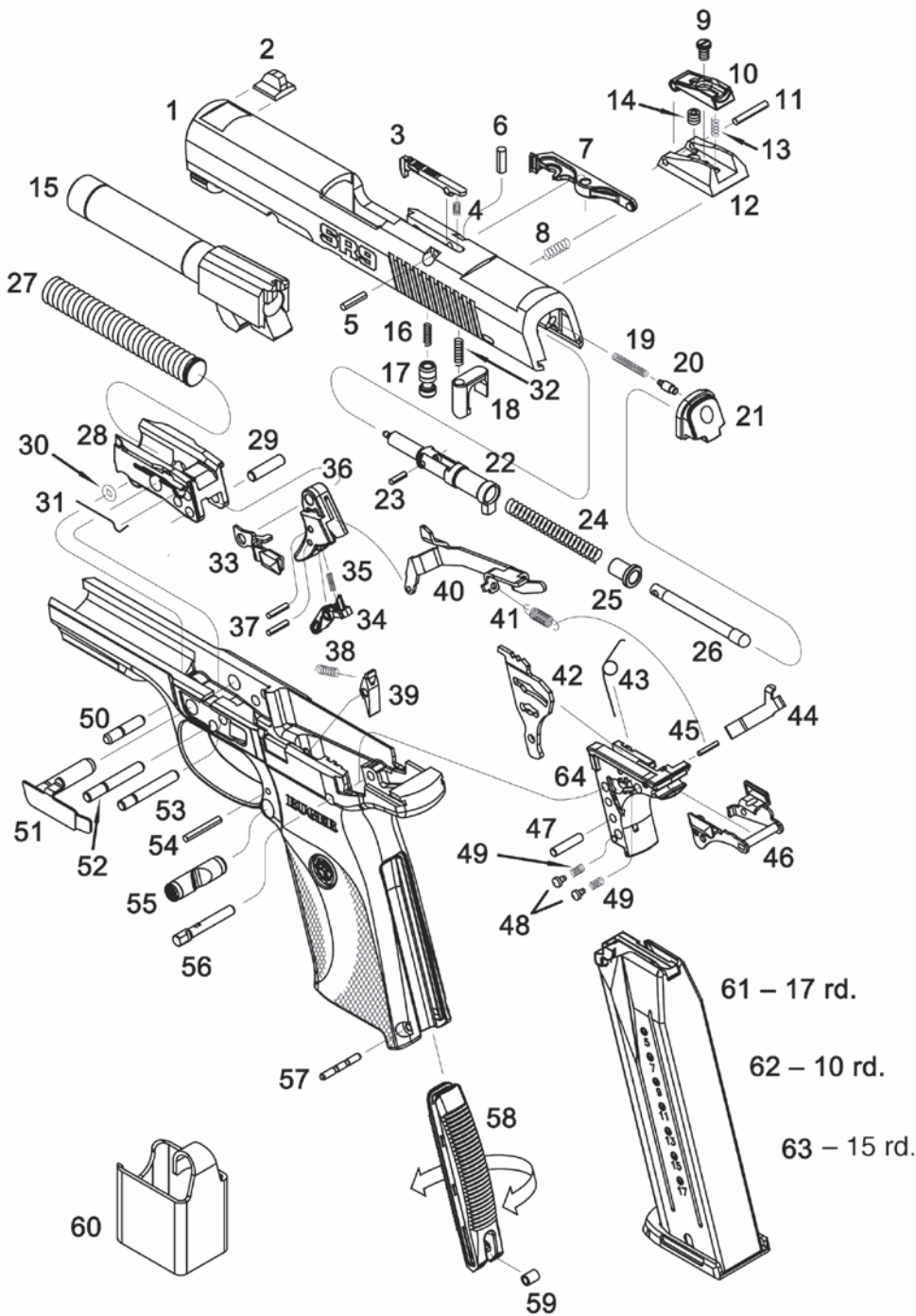

RUGER® SR9c® & SR40c®

PARTS LIST

Design, prices and specifications subject to change without notice.

SPECIFY MODEL, CALIBER, AND SERIAL NO. WHEN ORDERING

(See Exploded View on Page 44)

Key No.	Part Name
* 1	Slide
2	Front Sight
3	Loaded Chamber Indicator
4	Loaded Chamber Indicator Spring
5	Loaded Chamber Indicator Pin
6	Extractor Pivot Pin
7	Extractor, Blackened Steel
8	Extractor Spring
9	Rear Sight Elevation Screw
10	Rear Sight Leaf
11	Rear Sight Pivot Pin
12	Rear Sight Base
13	Rear Sight Elevation Spring
14	Rear Sight Lock Screw
* 15	Barrel – 9mm
16	Striker Blocker Spring
17	Striker Blocker
18	Magazine Disconnect
19	Striker Cover Spring
20	Striker Cover Plunger
21	Striker Cover
22	Striker
23	Striker Cross Pin
24	Striker Spring
25	Striker Spring Cup
26	Striker Shaft
27	Guide Rod Assembly
28	Camblock
29	Trigger Pivot Pin
30	Camblock Pin, Front Retainer
31	Camblock Pin Retainer
32	Slide Stop Spring
33	Slide Stop Lever
34	Trigger, Inner
35	Trigger, Inner Spring
36	Trigger, Outer
37	Trigger Outer Pin, 2 Req'd
38	Magazine Latch Spring
39	Magazine Latch
* 40	Trigger Bar
41	Trigger Bar Spring
42	Ejector

* PARTS SO MARKED MUST BE FACTORY FIT

Key No.	Part Name
43	Trigger Bar Lift Spring
44	Trigger Bar Reset
45	Trigger Bar Spring Mounting Pin
46	Thumb Safety Assembly
47	Ejector Pivot Pin
48	Safety Detent Plunger, 2 Req'd
49	Safety Detent Spring, 2 Req'd
50	Camblock Pin, Front
51	Takedown Pin Assembly
52	Camblock Pin, Lower
53	Camblock Pin, Upper
54	Magazine Latch Pivot Pin
55	Magazine Latch Thumbpiece
56	Fire Control Housing Pin
57	Backstrap Pin
58	Backstrap Insert
59	Magazine Loading Tool
60	Magazine - 17-round
61	Magazine - 10-round
62	Fire Control Housing
63	Magazine Adapter, Black
64	Floorplate Finger Extension
65	Magazine Disconnect Spring

Also Available, but Not Illustrated
Case Only

RUGER® SR9c® & SR40c®

EXPLODED VIEW

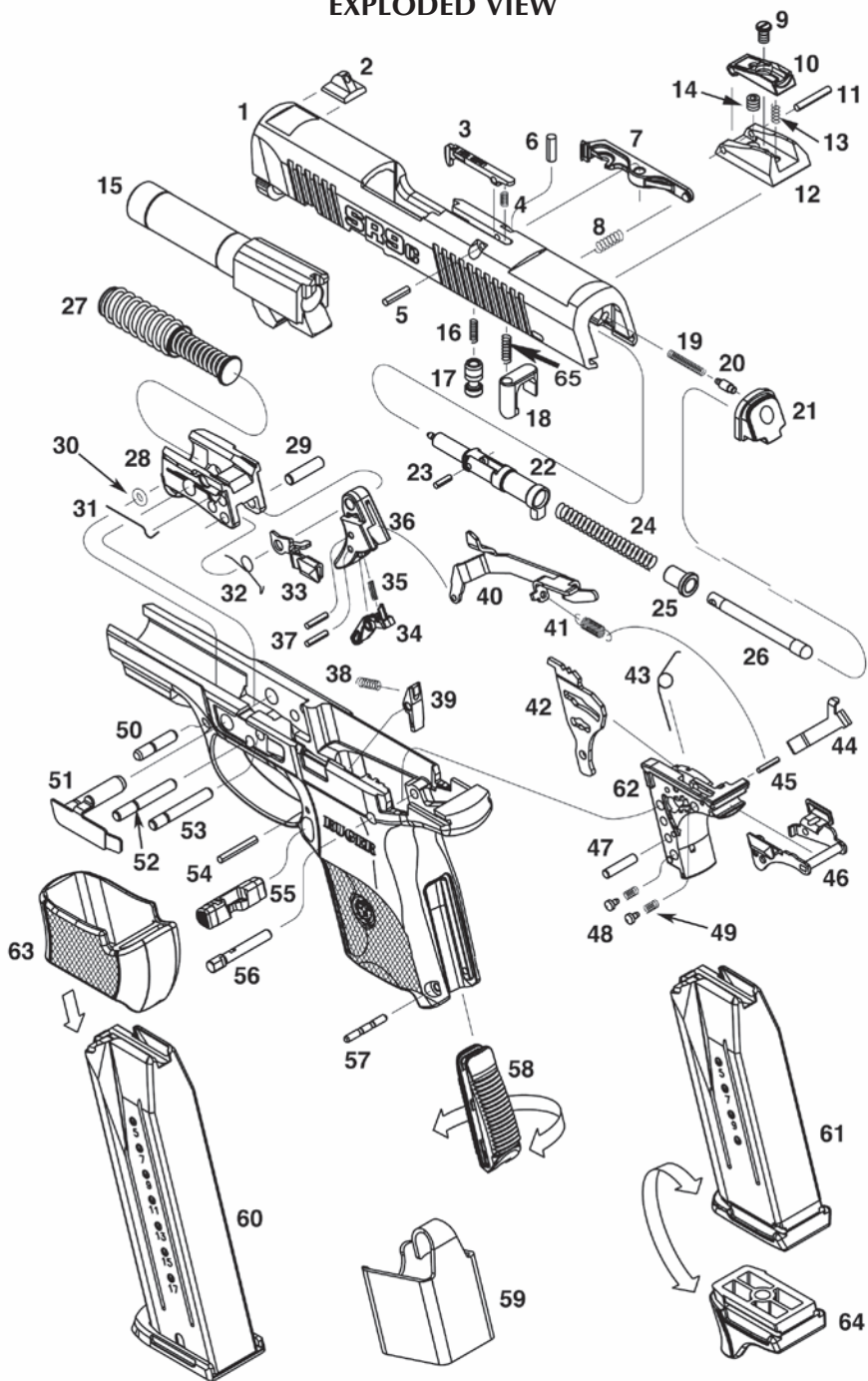

RUGER® 9E™

SUPPLEMENTAL PARTS LIST & EXPLODED VIEW

See Pages 39 - 41 For All Other Parts Lists
and Exploded View Drawings

Key No.	Part Name
* 1	Slide
2	Front Sight
12	Rear Sight
21	Striker Cover

* PARTS SO MARKED MUST BE FACTORY FITTED.

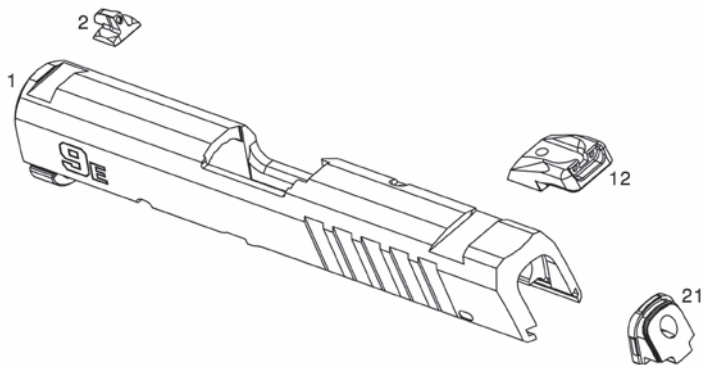

THE BASIC RULES OF SAFE FIREARMS HANDLING

We believe that Americans have a right to purchase and use firearms for lawful purposes. The private ownership of firearms in America is traditional, but that ownership imposes the responsibility on the gun owner to use his firearms in a way which will ensure his own safety and that of others. When firearms are used in a safe and responsible manner, they are a great source of pleasure and satisfaction, and represent a fundamental part of our personal liberty.

Firearms do not cause accidents! Firearms accidents are almost always found to have been the result of carelessness or ignorance on the part of the shooter of the basic rules of safe gun handling.

The following rules must be observed by gun users at all times. Safe gun handling is not just desirable, it is absolutely essential to your safety, the safety of others, and the continuation of gun ownership and sport shooting as we know it today.

1. LEARN THE MECHANICAL AND HANDLING CHARACTERISTICS OF THE FIREARM YOU ARE USING.

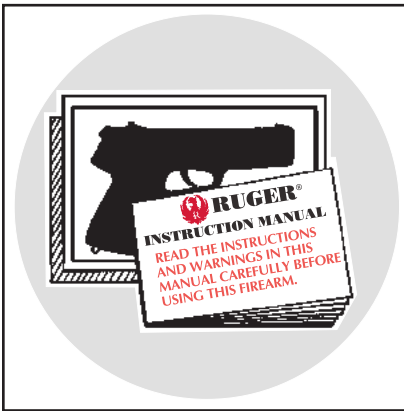

Not all firearms are the same. The method of carrying and handling firearms varies in accordance with the mechanical provisions for avoiding accidental discharge and the various proper procedures for loading and unloading. No person should handle any firearm without first having thoroughly familiarized himself with the particular type of firearms he is using, and with safe gun handling in general.

2. ALWAYS KEEP THE MUZZLE POINTED IN A SAFE DIRECTION.



Be sure of the bullet stop behind your target, even when dry-firing. Never let the muzzle of a firearm point at any part of your body or at another person. This is particularly important when loading or unloading a firearm. In the event of an accidental discharge, no injury can occur as long as the muzzle is pointing in safe direction. A safe direction means a direction that will not permit a discharged bullet to strike a person, or to strike an object from which the bullet may ricochet.

A safe direction must take into account the fact that a bullet may penetrate a wall, ceiling, floor, window, etc., and strike a person or damage property. Make it a habit to know exactly where the muzzle of your gun is pointing whenever you handle it, and be sure that you are always in control of the direction in which the muzzle is pointing, even if you fall or stumble. Keep your finger off the trigger until you are ready to shoot.

3. FIREARMS SHOULD BE UNLOADED WHEN NOT IN USE.

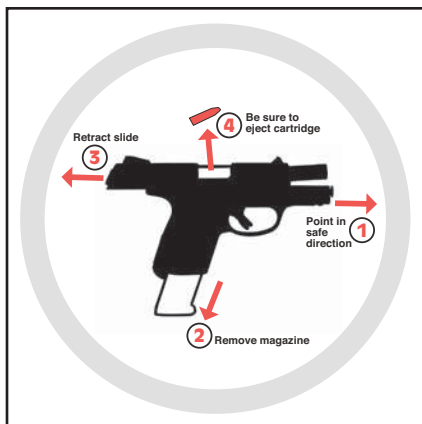

Firearms should be loaded only when you are in the field or on the target range or shooting area, ready to shoot. Firearms and ammunition should be securely locked in safes, racks or cabinets, or by using the locking device supplied with the firearm when not in use. Ammunition should be safely stored separate from firearms. Store your firearms out of sight of visitors and children. It is the gun owner's responsibility to be certain that children and persons unfamiliar with firearms cannot gain access to firearms, ammunition, or components.

4. BE SURE THE BARREL IS CLEAR OF OBSTRUCTIONS BEFORE SHOOTING.

Even a bit of mud, snow or excess lubricating oil or grease in the bore may cause the barrel to bulge, or even burst on firing, and can cause injury to the shooter and bystanders. Be sure that you are using ammunition of the proper caliber and loading for the gun you are using. If the report or recoil on firing seems weak, or doesn't seem quite right, CEASE FIRING IMMEDIATELY, unload your firearm, and check to be sure that no obstruction has become lodged in the barrel. Never try to shoot an obstruction out!





5. BE SURE OF YOUR TARGET BEFORE YOU SHOOT.

Don't shoot unless you know exactly where your bullet is going to strike. Be sure of the bullet stop behind your target, even when dry-firing with an unloaded gun. If you are in the field hunting, do not fire at a movement or noise. Take the time to be absolutely certain of your target before you pull the trigger.

6. WEAR SHOOTING GLASSES AND HEARING PROTECTION WHEN YOU SHOOT.

All shooters should wear protective shooting glasses and adequate hearing protection when shooting. Exposure to shooting noise can damage hearing, and wearing adequate eye protection when shooting is essential.



7. NEVER CLIMB A TREE OR FENCE WITH A LOADED FIREARM.

Put the firearm down carefully before climbing a fence, and unload it before climbing or descending a tree or jumping over a ditch or other obstruction. Never pull or push a loaded firearm toward yourself or another person. When in doubt, or whenever you are about to do anything awkward, unload your gun!

8. DON'T SHOOT AT A HARD SURFACE OR AT WATER.

Bullets can glance off many surfaces like rocks or the surface of water and travel in unpredictable directions with considerable velocity.



9. NEVER TRANSPORT A LOADED FIREARM.

Firearms should always be unloaded before being moved or placed in a vehicle. A suitable carrying case or scabbard should be used to carry an unloaded firearm to and from the shooting area.

10. AVOID ALCOHOLIC BEVERAGES WHEN SHOOTING.

Don't drink until the day's shooting is over. Handling firearms while under the influence of alcohol in any form, or medications that could affect your judgement or coordination, constitutes a criminal disregard for the safety of others.



A BRIEF ACCOUNT OF AN EXTRAORDINARY ACHIEVEMENT: RUGER® FIREARMS

Sturm, Ruger & Company, Inc., had its beginning in a small machine shop occupying a rented frame building in Southport, Connecticut. In January, 1949, with an initial investment of only \$50,000 and an idea, William B. Ruger and Alexander M. Sturm started production of a .22 caliber autoloading pistol—a design which was so successful that it became the cornerstone upon which one of the most comprehensive lines of sporting firearms ever made in America was established. After Alex Sturm's death in 1951, William B. Ruger continued to direct the Company until his death in 2002. William B. Ruger, Jr. continued to provide guidance, which helped make this Company a sound and successful enterprise, until his retirement in 2006. The Company has continued to prosper, under new management and guidance from our Board, with new products and fresh perspectives.

Ruger, in this relatively short time, has established itself as a leading small arms design organization, developing a unique and broad line of fine quality sporting, military and police firearms to become one of the world's most famous producers of revolvers, pistols, rifles and shotguns. Since 1949, Ruger craftsmen have built many millions of firearms.

During its five decades of growth and progress under the leadership of William B. Ruger, the Company developed a business philosophy and implemented policies which represent a constructive influence in the life of modern America. From the beginning, Ruger played a positive role in conservation efforts and has supported the interests of shooters through such groups as the National Rifle Association, National Shooting Sports Foundation, and many regional sportsmen's organizations.

The Company has always endeavored to market its firearms for constructive and recreational purposes, to emphasize the traditional and responsible aspects of shooting, to render meaningful public services, and to encourage shooters in constructive, responsible, and safe participation in the shooting sports. Its motto, "Arms Makers For Responsible Citizens®," exemplifies this Company philosophy.

Today, Ruger® is particularly mindful of those elements which have contributed to the creation of its success, and extends heartfelt thanks to its many loyal employees and customers.

The firearms catalog, and instruction manuals for all Ruger® firearms, can be downloaded from our website at:

www.ruger.com

NOTES

WHY NO WARRANTY CARD HAS BEEN PACKED WITH THIS NEW RUGER® FIREARM

The Magnuson-Moss Act (Public Law 93-637) does not require any seller or manufacturer of a consumer product to give a written warranty. It does provide that if a written warranty is given, it must be designated as "limited" or as "full" and sets minimum standards for a "full" warranty. Sturm, Ruger & Company, Inc. has elected not to provide any written warranty, either "limited" or "full", rather than to attempt to comply with the provisions of the Magnuson-Moss Act and the regulations issued thereunder. There are certain implied warranties under state law with respect to sales of consumer goods. As the extent and interpretation of these implied warranties varies from state to state, you should refer to your state statutes. Sturm, Ruger & Company wishes to assure its customers of its continued interest in providing service to owners of Ruger® firearms.



STURM, RUGER & COMPANY, INC.
200 Ruger Road
Prescott, Arizona 86301 U.S.A.
www.ruger.com

Arms Makers For Responsible Citizens®

**A COPY OF THE INSTRUCTION MANUAL FOR ANY RUGER®
FIREARM IS AVAILABLE FROM THE FACTORY FREE ON REQUEST, OR IT MAY BE
DOWNLOADED FROM OUR WEBSITE AT WWW.RUGER.COM.
THESE INSTRUCTION MANUALS CONTAIN IMPORTANT
WARNINGS WHICH MUST BE UNDERSTOOD
BEFORE USING THESE FIREARMS.**

The Following are Sturm, Ruger & Co., Inc. Trademarks: "BX-Trigger," "Bisley," Eagle "SR," "Elite 452," "Gold Label," "It's Mine and It's American," "LC6," "LCR-357," "LCRx," "Mark II," "Mark III," "Match Champion," "Model 96," "P345D," "P345PR," "P85," "P90," "P91," "P93," "P94," "P95," "P97," "Ruger Marksman Adjustable," "Ruger 77/50," "Ruger 10/17," "77/357," "Single-Seven," "SR45," "SR-556C," "SR-556VT," "SR-762," "10/22-FS," "22 Charger," "22/45," and "22/45 RP."

The Following are Registered U.S. Trademarks Belonging to Sturm, Ruger & Co., Inc.: "RUGER," Sturm, Ruger Logo, "AC-556," "AR-556," "Arms Makers For Responsible Citizens," "All-Weather," "Bearcat," "Blackhawk," "BX-15," "BX-25," Eagle "R," "GP100," Hard "R" Logo, "Hawkeye," "LC380," "LC9," "LC9s," "LCP," "LCR," "M77," "Mini Thirty," "Mini-14," "9E," "Old Army," "Power Bedding," "P345," "Redhawk," "Ruger American Rifle," "Ruger American Rimfire," "Ruger Hunting," "Ruger Hunting" Logo, "Ruger Inside & Out" phrase & logo design, "Ruger 77/17," "Ruger 77/22," "Ruger 77/44," "Ruger SP101," "Ruger 10/22 Takedown" phrase & logo design, "Ruger Titanium," "Ruger 22/45 Lite," "Ruger Vaquero," "Rugged, Reliable Firearms," "Security-Six," "Service-Six," "Single-Nine," "Single-Six," "Single-Ten," "Speed-Six," the "SR" Design, "SR9," "SR9c," "SR40," "SR40c," "SR-22," "SR22," "SR-556," "SR-556E," "SR1911," "Super Redhawk Alaskan," "Target Grey," "10/22," and "10/22 Takedown."