

# M&P<sup>®</sup>

by **Smith & Wesson<sup>®</sup>**

## Safety & Instruction Manual



For  
**M&P<sup>®</sup> BODYGUARD<sup>®</sup>380**  
with or without manual thumb safety

and



**M&P<sup>®</sup> BODYGUARD<sup>®</sup>380**  
**Integrated Crimson Trace<sup>®</sup> Laser**  
with or without manual thumb safety

# M&P<sup>®</sup> BODYGUARD<sup>®</sup> 380



**Read the instructions and  
warnings in this manual  
CAREFULLY BEFORE  
using this firearm.**

2100 Roosevelt Avenue • Springfield, MA 01104  
1-800-331-0852 • Fax: 413-747-3317  
[www.smith-wesson.com](http://www.smith-wesson.com)

Copyright © 2018 Smith & Wesson Corp.  
All rights reserved.



**WARNING:**  
**READ THESE**  
**INSTRUCTIONS AND WARNINGS**  
**CAREFULLY. BE SURE YOU**  
**UNDERSTAND THESE**  
**INSTRUCTIONS AND WARNINGS**  
**BEFORE USING THIS FIREARM.**  
**FAILURE TO READ THESE**  
**INSTRUCTIONS AND TO FOLLOW**  
**THESE WARNINGS MAY RESULT**  
**IN SERIOUS INJURY OR DEATH**  
**TO YOU AND OTHERS AND**  
**DAMAGE TO PROPERTY.**



**This SAFETY & INSTRUCTION**  
**MANUAL** should always  
accompany this firearm and be  
transferred with it upon change of  
ownership or when presented to  
another person. A copy of the  
**SAFETY & INSTRUCTION**  
**MANUAL** is available **FREE**  
via download at  
[www.smith-wesson.com](http://www.smith-wesson.com)  
or upon request from:

**SMITH & WESSON®**  
**CUSTOMER SUPPORT CENTER**  
2100 ROOSEVELT AVENUE  
SPRINGFIELD, MA 01104  
TEL.: 1-800-331-0852, ext. 4125  
E-mail: [qa@smith-wesson.com](mailto:qa@smith-wesson.com)

**TABLE OF CONTENTS**

YOUR SAFETY RESPONSIBILITIES .....	3-7
SAFE STORAGE AND TRANSPORTATION .....	7-8
AMMUNITION .....	9-11
MODEL AND FEATURES IDENTIFICATION .....	12
INSPECTING YOUR PISTOL .....	13-14
LOADED CHAMBER INDICATOR .....	15
PREPARATION FOR FIRING .....	15-16
LOADING .....	16-18
FIRING .....	19
CLEARING MISFIRES .....	20
UNLOADING .....	21
FIELD STRIPPING / DISASSEMBLY .....	22-24
LUBRICATION .....	24
FIELD STRIPPING / ASSEMBLY .....	25-27
SIGHT ADJUSTMENT .....	28
MAGAZINE .....	29
MANUAL THUMB SAFETY (when pistol is so-equipped) .....	30
CLEANING AND MAINTENANCE .....	31-33
LIMITED WARRANTY ON PISTOL .....	33-34
CONTACT AND SHIPPING INFORMATION .....	35-36
CUSTOM SERVICE .....	37
INT'L WARRANTY CENTERS AND PATENT INFO .....	38
APPENDIX "A" CRIMSON TRACE® INTEGRATED LASER Operation & Maintenance (if pistol is so-equipped) .....	40-51
BATTERY WARNINGS .....	52

**YOUR SAFETY RESPONSIBILITIES****SAFETY IS YOUR NUMBER ONE  
RESPONSIBILITY!!!!**

- At home, in the field, at the range, or anywhere, the first concern of every firearm owner should be safety. Apply the following safety rules in every situation, with any kind of firearm. If you feel uncertain about any operational aspects of your firearm, please contact Smith & Wesson® at 1-800-331-0852, ext. 4125 before proceeding with its operation.
- If you are unfamiliar with firearms you should seek formal training before using your pistol.



**WARNING: YOU MUST FOLLOW ALL OF THESE SAFETY RULES TO ENSURE THE SAFE USE OF YOUR FIREARM. THE FAILURE TO FOLLOW THE INSTRUCTIONS AND WARNINGS IN THIS MANUAL COULD CAUSE SERIOUS PERSONAL INJURY OR DEATH TO YOU OR OTHERS AND DAMAGE TO PROPERTY.**

- As a firearm owner, you accept a demanding responsibility. How seriously you take this responsibility can be the difference between life and death. There is no excuse for careless or abusive handling of your firearm. At all times handle your firearm with intense respect for its power and potential danger.

---

## YOUR SAFETY RESPONSIBILITIES CONTINUED

---

- **ALWAYS KEEP YOUR FIREARM POINTED IN A SAFE DIRECTION.** Never point a firearm at anyone or anything you do not intend to shoot whether or not it is loaded. This is particularly important when loading, unloading, or field stripping the gun. ALWAYS control the direction of the firearm.
- **ALWAYS TREAT EVERY FIREARM AS IF IT IS LOADED AND WILL FIRE.** Do not take anyone's word that the firearm is unloaded – always check for yourself. Never pass your firearm to another person until the cylinder or action is open and you visually check that it is unloaded. Keep your firearm unloaded and safely stored when not in use.
- **NEVER PLACE YOUR FINGER INSIDE THE TRIGGER GUARD OR ON THE TRIGGER UNLESS YOU INTEND TO FIRE.** Ensure that other objects do not touch the trigger.
- **ALWAYS BE SURE OF YOUR TARGET AND WHAT IS BEYOND IT.** Always be sure of where the bullet will strike and shoot only where there is a safe back stop free of obstructions, water or other surfaces which can cause ricochets. Be sure your bullet will stop behind your target. Bullets can glance off many surfaces like rocks or the surface of water and travel in unpredictable directions with considerable velocity. Do not fire randomly into the sky.
- **NEVER CROSS OBSTACLES SUCH AS FENCES OR STREAMS WITH A LOADED FIREARM.** Always make certain your firearm is unloaded before crossing a fence, climbing a tree, jumping a ditch or negotiating other obstacles.
- **SAFE GUN HANDLING IS YOUR PERSONAL RESPONSIBILITY AT ALL TIMES.** Firearms are dangerous and can cause serious injury or death if they are misused or used inappropriately. Safety must be the prime consideration of any one who owns or handles firearms. Accidents are the result of violating the rules of safe gun handling and common sense. Firearm safety training is available. Contact your firearms dealer, law enforcement agency, local sportsman's club, etc. for availability.
- **YOU ARE RESPONSIBLE FOR THE FIREARM AT ALL TIMES.** In owning a firearm, you must undertake full-time responsibility for your firearm's safety and security. You must protect yourself and all others against injury or death from misuse of the firearm 24 hours a day.
- **FIREARM SECURITY IS YOUR RESPONSIBILITY.** You must secure firearms safely from children and/or unauthorized users. Your firearm should always be kept unloaded and locked when not in use. A lock has been provided for this purpose. Never assume that the use of this lock is sufficient to safely secure your firearm. You must always evaluate your personal situation and employ the security systems that meet your needs and prevent children and unauthorized users from gaining access to your firearm.

---

## YOUR SAFETY RESPONSIBILITIES CONTINUED

---

- **APPROPRIATE USE FOR YOUR FIREARM MEANS USING YOUR FIREARM FOR LEGAL PURPOSES.** For example - target shooting, hunting and lawful resistance of deadly criminal force. It is your responsibility to ensure that you are in compliance with all applicable laws and ordinances regarding the use of your firearm.
- **NEVER RELY ON MECHANICAL FEATURES ALONE.** Only your safe gun-handling habits will ensure the safe use of your firearm. This is your responsibility.
- **ALWAYS SAFELY STORE AND SECURE YOUR FIREARM.** Safe and secure storage of your firearm is one of your most important responsibilities. It is a full-time responsibility. You must always secure your firearm and ammunition separately so that they are not accessible to children and/or other unauthorized persons.
- **NEVER KEEP AMMUNITION IN THE SAME LOCATION AS THE FIREARM.** Store each in a separate and secure place.
- **ALWAYS WEAR EYE PROTECTION THAT IS SPECIFIED FOR USE WITH FIREARMS** every time you handle your firearm for cleaning and maintenance.
- **ALWAYS WEAR EYE AND HEARING PROTECTION THAT ARE SPECIFIED FOR USE WITH FIREARMS** every time you discharge your firearm. Make sure others in the vicinity of where you will be shooting do so as well.
- **VISIBLE LASER RADIATION EMITS FROM THE INTEGRATED CRIMSON TRACE® LASER SIGHT (WHEN M&P® BODY-GUARD®380 IS SO EQUIPPED) WHILE THE LASER SIGHT IS IN OPERATION – AVOID DIRECT EYE EXPOSURE TO THE LASER BEAM.**
  - Do not stare into the laser beam.
  - Do not look into the laser beam through binoculars or telescopes.
  - Do not point the laser beam at mirror-like surfaces.
  - Do not shine the laser beam into another individual's eyes or into a pet's eyes.
- **NEVER USE ALCOHOL OR DRUGS BEFORE OR WHILE SHOOTING.** Do not use your firearm if you are on any medication which impairs, even slightly, your mental or physical ability.
- **ALWAYS HAVE ADEQUATE VENTILATION.** Discharging firearms in poorly ventilated areas, cleaning firearms, or handling ammunition may result in exposure to lead and other substances known to cause birth defects, reproductive harm, and other serious physical injury. Review the warnings and labels for all ammunition and cleaning products carefully. Wash hands thoroughly after exposure.

---

## YOUR SAFETY RESPONSIBILITIES CONTINUED

---

- **BEFORE HANDLING ANY FIREARM, UNDERSTAND ITS OPERATION.** Not all firearms are the same. Familiarize yourself with the mechanical features of any firearm you intend to use. If you feel uncertain about any operational aspects of your firearm, please contact Smith & Wesson® at 1-800-331-0852, ext. 4125 before proceeding with its operation.
- **NEVER ALLOW A FIREARM TO BE USED BY INDIVIDUALS WHO DO NOT UNDERSTAND ITS SAFE OPERATION OR HAVE NOT READ THESE FIREARM SAFETY RULES.**
- **ALWAYS USE THE CORRECT AMMUNITION FOR YOUR PARTICULAR FIREARM** as indicated by the marking on the barrel. Never use non-standard, reloaded, or “handloaded” ammunition which has not been subjected to internal ballistic pressure testing.
- **BEWARE OF BARREL OBSTRUCTIONS** Be sure the barrel is clear of obstructions before shooting. Mud, water, snow or other objects may inadvertently lodge in the barrel bore. A small obstruction can cause a dangerous increase in pressure and may damage your gun and cause injury to yourself and others.
- **BE SURE ALL ACCESSORIES, SUCH AS HOLSTERS, GRIPS, SLINGS, SCOPES AND OTHER ACCESSORIES ARE COMPATIBLE** with the firearm and that the accessories do not interfere with safe operation. It is your responsibility to understand and follow all of the instructions in this manual, as well as those which may be supplied with your ammunition and any accessory.
- **NEVER DISASSEMBLE YOUR FIREARM** beyond the field stripping procedure outlined in this manual. Improper disassembly or reassembly of your firearm may be dangerous and can lead to serious injury or death.
- **NEVER MANIPULATE, ADJUST OR CHANGE ANY OF THE INTERNAL COMPONENTS OF YOUR FIREARM UNLESS SPECIFICALLY INSTRUCTED TO DO SO IN THIS MANUAL.** Improper manipulation of any other internal component may affect the safety and reliability of your firearm and may cause serious injury or death.
- **NEVER ALLOW ANY ALTERATION OR REPLACEMENT OF PARTS IN YOUR SMITH & WESSON® FIREARM UNLESS PERFORMED BY A QUALIFIED GUNSMITH** using genuine Smith & Wesson® parts. If you do otherwise, improper functioning of your firearm may occur and serious injury or death and damage to property may result.

---

## YOUR SAFETY RESPONSIBILITIES CONTINUED

---



**WARNING: SAFE USE OF A FIREARM IS YOUR PERSONAL RESPONSIBILITY AND THE FAILURE TO FOLLOW ALL OF THESE BASIC SAFETY RULES MAY RESULT IN SEVERE PERSONAL INJURY OR DEATH TO YOU OR OTHERS AND DAMAGE TO PROPERTY. YOU ARE THE MOST IMPORTANT SAFETY DEVICE WHEN IT COMES TO THE USE OF YOUR FIREARM AND SMITH & WESSON® WILL NOT BE RESPONSIBLE FOR ANY PERSONAL INJURY, DEATH OR PROPERTY DAMAGE THAT RESULTS FROM:**

- (1) THE CRIMINAL OR NEGLIGENT USE OF THIS FIREARM;**
- (2) A DISREGARD OF THESE SAFETY INSTRUCTIONS AND WARNINGS;**
- (3) IMPROPER OR CARELESS HANDLING OF THIS FIREARM;**
- (4) THE USE OF NON-STANDARD, DEFECTIVE, OR IMPROPER AMMUNITION;**
- (5) IMPROPER OR NEGLIGENT MODIFICATIONS OR REPAIRS TO THE FIREARM.**

---

## SAFE STORAGE AND TRANSPORTATION

---



**WARNING: ALWAYS POINT THE MUZZLE IN A SAFE DIRECTION.**



**WARNING: FIREARMS ARE DANGEROUS WHEN USED AND STORED IMPROPERLY. THEY POSE A RISK OF SERIOUS OR FATAL INJURIES. FIREARMS CAN BE ESPECIALLY DANGEROUS TO CHILDREN WHEN THEY ARE STORED IN AN IRRESPONSIBLE AND UNSAFE MANNER. FOR YOUR SAFETY AND THE SAFETY OF OTHERS, IT IS IMPERATIVE THAT YOU KEEP YOUR FIREARM LOCKED AND UNLOADED IN A SECURE PLACE. THE AMMUNITION SHOULD BE STORED IN A SEPARATE, SECURE LOCATION WHEN IT IS NOT IN USE. SAFE AND SECURE STORAGE OF YOUR FIREARM IS ONE OF THE MOST IMPORTANT RULES OF FIREARM SAFETY. YOUR FAILURE TO FOLLOW THESE RULES MAY RESULT IN SERIOUS INJURY OR DEATH TO YOU OR OTHERS.**

- **ALWAYS SECURE YOUR FIREARM IN A MANNER THAT WILL PREVENT UNAUTHORIZED ACCESS.** Whenever your firearm is not in use, keep it unloaded and locked. Your safety and the safety of others requires that you always secure and store your firearm in a manner that will prevent unauthorized access. Never leave a firearm unattended unless it is locked, unloaded and secured.

---

## SAFE STORAGE AND TRANSPORTATION CONTINUED

---

- **ALWAYS USE THE LOCK PROVIDED BY SMITH & WESSON® TO SECURE YOUR FIREARM.** Please read and follow the instructions packaged separately for the use of this lock. A lock, when properly used, can be an effective tool in preventing unauthorized access to your firearm. There are other alternative locks and safe storage containers available in the marketplace which may also be appropriate for your particular needs. Consult your local gun shop, hardware store, or local police department for guidance on the variety of other safe storage devices or practices which may be appropriate for your particular needs. By purchasing this firearm you have accepted the responsibility of safely securing the firearm at all times and preventing its unauthorized use. Never assume that the use of this lock alone is sufficient to safely secure your firearm. It is your personal responsibility to select and use whatever measures or practices that will enable you to be absolutely certain that your firearm is secure at all times.



**WARNING: NEVER LOCK A LOADED FIREARM AND NEVER LOAD A LOCKED FIREARM!**

- **ALWAYS STORE YOUR FIREARM AND AMMUNITION SEPARATELY** so that they are not accessible to children or other unauthorized persons. Safe and secure storage of your firearm and ammunition are your responsibility. It is a full-time responsibility.
- **NEVER ASSUME THAT A "HIDING" PLACE IS A SECURE STORAGE METHOD.** Others may be aware of your storage location or come upon it by chance. It is your personal responsibility to use common sense when storing your firearm and ammunition and to always make sure they are not accessible to children or other unauthorized persons.
- **NEVER TRANSPORT A LOADED FIREARM.** When transporting your firearm, be sure it is unloaded and locked. Safe and secure transportation of your firearm is your responsibility.
- **ALWAYS FOLLOW THE LAW!** Many jurisdictions have laws that make it a crime to keep a firearm unlocked and in an area accessible to children or others. Keeping a firearm locked and unloaded when not in use is not only common sense safety practice... IT IS THE LAW. You must be familiar with all local, state, and federal laws regarding the safe storage and transportation of your firearm. Failure to know and follow the law may result in unauthorized access or use of your firearm by another. Obey all laws relating to the storage and transportation of firearms. Your local police department or gun shop can furnish you with available information on storing and/or transporting a firearm safely and legally.
- **YOUR FIREARM IS YOUR RESPONSIBILITY.** You must prevent your firearm from being stolen or from being used by untrained or unqualified individuals. Keep it locked, unloaded and secured when not in use.



# AMMUNITION

**WARNING: NEVER USE AMMUNITION NOT SPECIFICALLY DESIGNATED FOR USE IN YOUR FIREARM. FAILURE TO USE THE CORRECT TYPE OR CALIBER OF AMMUNITION MAY CAUSE THE FIREARM TO JAM, OR FAIL TO FIRE, OR MAY GENERATE EXCESSIVE PRESSURE WHICH CAN DAMAGE OR EVEN RUPTURE YOUR FIREARM, CAUSING PERSONAL INJURY OR DEATH TO THE SHOOTER OR BYSTANDERS.**

Locate the cartridge designation marked on the firearm (It is marked in one of two places on the M&P® BODYGUARD®380). This information indicates the correct ammunition that must be used in this firearm (FIGURES 1a and 1b).

You are responsible for selecting ammunition that meets industry standards and is appropriate in type and caliber for this firearm.

Never mix ammunition.

**WARNING: IN SOME CASES, A ROUND OF AMMUNITION NOT SPECIFIED ON YOUR FIREARM AND NOT LISTED AS ALTERNATE AMMUNITION IN THIS MANUAL, MAY FIT INTO THE CHAMBER. FIRING THIS AMMUNITION MAY CAUSE A RUPTURE RESULTING IN DAMAGE TO THE FIREARM AND PERSONAL INJURY OR**

**DEATH TO THE SHOOTER OR BYSTANDERS. FOR MORE INFORMATION REGARDING UNSAFE CALIBER COMBINATIONS, REFER TO THE FOLLOWING URL:**

**HTTP://WWW.SAAMI.ORG/SPECIFICATIONS\_AND\_INFORMATION/PUBLICATIONS/DOWNLOAD/SAAMI\_ITEM\_211-UNSAFE\_ARMS\_AND\_AMMUNITION\_COMBINATIONS.PDF**

**WARNING: DISCHARGING FIREARMS IN POORLY VENTILATED AREAS, CLEANING FIREARMS, OR HANDLING AMMUNITION MAY RESULT IN EXPOSURE TO LEAD AND OTHER SUBSTANCES KNOWN TO CAUSE BIRTH DEFECTS, REPRODUCTIVE HARM, AND OTHER SERIOUS PHYSICAL INJURY. HAVE ADEQUATE VENTILATION AT ALL TIMES. WASH HANDS THOROUGHLY AFTER EXPOSURE.**

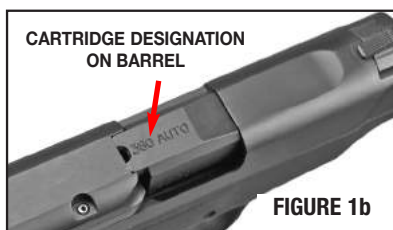
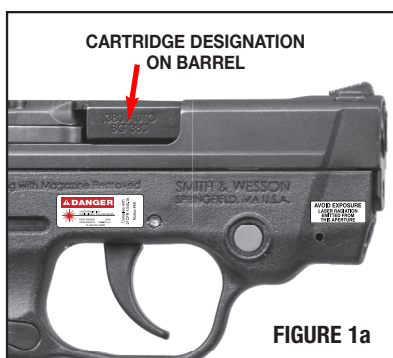

---

## AMMUNITION CONTINUED

---

- Use only commercially manufactured ammunition with internal ballistic pressures which are in strict accordance with the specifications of the Sporting Arms and Ammunition Manufacturers' Institute (SAAMI). If you are uncertain, contact your ammunition supplier for verification.



**WARNING: NEVER USE NON-STANDARD, RELOADED OR "HANDLOADED" AMMUNITION WHICH HAS NOT BEEN SUBJECTED TO INTERNAL BALLISTIC PRESSURE TESTING. RELOADED OR HANDLOADED AMMUNITION, MAY HAVE MANY MANUFACTURING AND QUALITY VARIABLES (SUCH AS THE TYPE AND AMOUNT OF GUN POWDER). CARTRIDGE CASES THAT HAVE BEEN RELOADED AND FIRED MULTIPLE TIMES MAY SUFFER PHYSICAL DAMAGE WHICH COULD SIGNIFICANTLY IMPACT OR REDUCE THE INTEGRITY OF THE CARTRIDGE, POSSIBLY RESULTING IN BULLET SETBACK OR UNSEATING. CASE FAILURE AND INJURY TO THE SHOOTER OR BYSTANDERS AND DAMAGE TO THE FIREARM MAY RESULT WHEN SUCH A ROUND IS FIRED. ANY AMMUNITION THAT IS IMPROPERLY MANUFACTURED OR RELOADED, EVEN IN THE SLIGHTEST DEGREE, MAY FAIL TO FIRE OR MAY GENERATE EXCESSIVE INTERNAL PRESSURES WHICH CAN DAMAGE OR EVEN RUPTURE THE FIREARM, CAUSING PERSONAL INJURY OR DEATH TO THE SHOOTER OR THOSE IN THE IMMEDIATE VICINITY.**

- A firearm and ammunition are a system and must work together. There are different types of ammunition for different types of firearms. Your firearm has been designed for ammunition of a specific type and a specific gauge or caliber. It is important to select the proper ammunition for your firearm.
- Different combinations of bullet velocity, bullet weight and firearm weight can have major impact on felt recoil; high felt recoil can be uncomfortable to some shooters.

For example:

- Firearm Weight: lower firearm weight increases felt recoil.
- Bullet Weight: higher bullet weight increases felt recoil.
- Bullet Velocity: higher bullet velocity increases felt recoil.

To acclimate yourself to higher levels of felt recoil, consider the following:

- Use a firm two-hand hold on the grip when firing.
- Always start your shooting experience with the lowest bullet velocity and lowest bullet weight available for your firearm.
- Ask your firearm dealer to suggest the lowest power, lowest velocity, lightest bullet weight for your firearm.

## AMMUNITION CONTINUED



**WARNING: NEVER USE AMMUNITION OF THE INCORRECT GAUGE OR CALIBER. USING AMMUNITION OF THE INCORRECT GAUGE OR CALIBER MAY CAUSE DAMAGE TO YOUR FIREARM AND POSSIBLE SERIOUS INJURY TO YOU AND TO OTHERS.**



**WARNING: NEVER USE CARTRIDGES OTHER THAN THOSE DESIGNATED BY THE MARKING ON THE FIREARM. DOING SO CAN RESULT IN DANGEROUSLY HIGH PRESSURES THAT MAY DAMAGE THE FIREARM AND POSSIBLY CAUSE SERIOUS INJURY TO YOURSELF AND OTHERS.**



**WARNING: DEATH, SERIOUS INJURY AND PROPERTY DAMAGE CAN RESULT FROM THE USE OF INCORRECT AMMUNITION OR BORE OBSTRUCTIONS. NEVER USE RELOADED AMMUNITION THAT HAS NOT BEEN SUBJECTED TO INTERNAL BALLISTIC PRESSURE TESTING. SEE PAGE 10 FOR DETAILS.**

- “Plus-P” (+P) ammunition generates pressures in excess of the pressures associated with standard ammunition. Such pressures may affect the wear characteristics and may result in the need for more frequent service.
- “Plus-P-Plus” (+P+) ammunition must not be used in Smith & Wesson firearms. This marking on the ammunition designates that it exceeds established industry standards, but the designation does not represent defined pressure limits and therefore such ammunition may vary significantly as to the pressures generated and could be DANGEROUS.

Marking on Firearm	Ammunition Type		
	Standard	+P	+P+
380 AUTO	OK	NO	NO
9mm	OK	OK	NO
9x21mm	OK	NO	NO
38 Super	OK	OK	NO
357 SIG	OK	NO	NO
40 S&W	OK	NO	NO
45 AUTO	OK	OK	NO

- Some brands of ammunition may cause difficulty in extracting spent cartridge cases from the chamber. If this situation occurs, thoroughly clean the chamber with solvent. If this condition persists, we recommend changing to another brand of ammunition.



**WARNING: ALWAYS INSPECT YOUR AMMUNITION BEFORE USING IT. NEVER USE DIRTY, CORRODED OR DAMAGED AMMUNITION. A BURST CARTRIDGE MAY RESULT CAUSING DAMAGE TO THE FIREARM AND PERSONAL INJURY OR DEATH TO THE SHOOTER OR BYSTANDERS.**

# MODEL AND FEATURES IDENTIFICATION

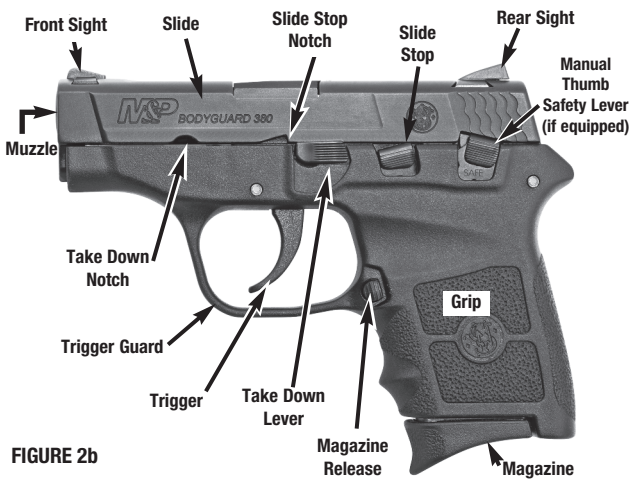
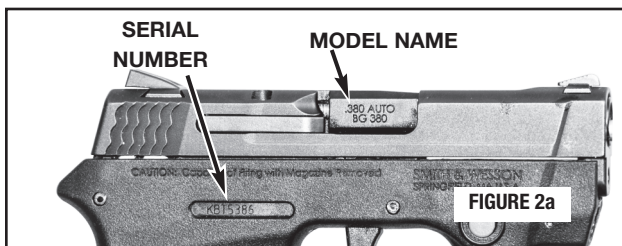

ON THOSE MODELS SO-EQUIPPED WITH AN INTEGRATED CRIMSON TRACE® LASER



**WARNING: YOU MUST DETERMINE WHICH FEATURES ARE PRESENT ON YOUR M&P® BODYGUARD®380 PISTOL AND HOW THOSE FEATURES OPERATE. VARIOUS MODELS OF THE M&P® BODYGUARD® PISTOLS ARE FITTED WITH DISTINCT FEATURES WHICH MAY INCLUDE; A MANUAL THUMB SAFETY AND AN INTEGRATED CRIMSON TRACE® LASER. READ THIS ENTIRE MANUAL TO DETERMINE HOW TO OPERATE YOUR PISTOL WITH ITS PARTICULAR FEATURE SET.**

# INSPECTING YOUR PISTOL



**WARNING: ALWAYS ENSURE THAT THE FIREARM IS UNLOADED BEFORE INSPECTING, DISASSEMBLING, ASSEMBLING OR CLEANING AND ALWAYS KEEP THE MUZZLE POINTED IN A SAFE DIRECTION.**

- When you inspect your pistol, you should first check for yourself to ensure that it is unloaded. To do this, grasp the pistol with your finger off the trigger and outside the trigger guard, point the muzzle in a safe direction, depress the magazine release and remove the magazine (FIGURE 3).



FIGURE 3

Remove Magazine

- Point the muzzle in a safe direction, place the safety lever (if your pistol is so-equipped) in the lowered "FIRE" position to allow the slide to be moved rearward (FIGURE 4).

On those models so-equipped with a manual thumb safety lever

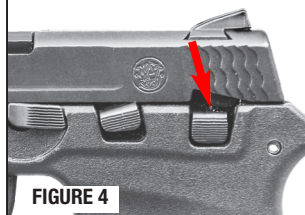

FIGURE 4

- Grasp the serrated sides of the slide from the rear with the thumb and fingers as shown (FIGURE 5), and briskly draw the slide fully rearward in order to extract any cartridge from the barrel chamber and clear it from the pistol. Do not obstruct the ejection port because doing so can interfere with ejection of a cartridge from the pistol.



FIGURE 5

- Lock the slide in the open position by allowing the slide to move slightly forward from the rearmost position while pressing upward on the slide stop (FIGURE 6).



FIGURE 6

## INSPECTING YOUR PISTOL CONTINUED

- Check the barrel chamber and bore visually for any obstructions (FIGURE 7).
- Check the firearm thoroughly to assure that no ammunition is present (FIGURE 8).



FIGURE 7

- Examine the breech face (FIGURE 9) to ensure that the firing pin is not protruding from the breech face (FIGURE 10). If the firing pin is protruding, do not attempt to load or fire the firearm. Bring the firearm to a gunsmith qualified to perform service on Smith & Wesson® firearms.

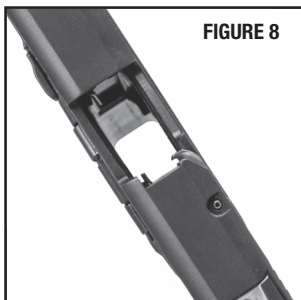

FIGURE 8

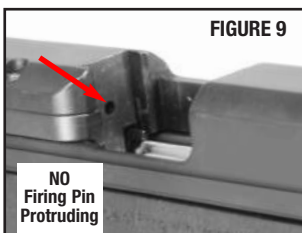

FIGURE 9

NO  
Firing Pin  
Protruding

Firing Pin  
Protruding

FIGURE 10

- You must follow this procedure every time a firearm leaves your hand, is cleaned, handed to you or another person, transported or stored.

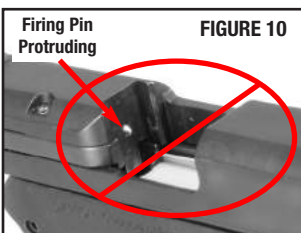

**WARNING: NEVER RELY ON MECHANICAL FEATURES ALONE. ONLY YOUR SAFE GUN HANDLING WILL ENSURE THE SAFE USE OF YOUR FIREARM. THIS IS YOUR RESPONSIBILITY.**

- Before using your pistol for the first time, it should be cleaned. See the cleaning section of this manual for more information.

## LOADED CHAMBER INDICATOR

**WARNING: NEVER RELY ON THE LOADED CHAMBER INDICATOR ALONE TO VERIFY THE PRESENCE OR ABSENCE OF A ROUND IN THE CHAMBER. TO DETERMINE THE PRESENCE OR ABSENCE OF A ROUND IN THE CHAMBER, LOOK INTO THE CHAMBER OF YOUR FIREARM AFTER FIRST REMOVING THE MAGAZINE AND THEN PULLING AND LOCKING THE SLIDE OPEN.**

- M&P® BODYGUARD®380 pistols come with a loaded chamber indicator. This indicator can be observed by looking at the top of the slide/ejection port (FIGURE 11), noting an opening at the rear of the barrel. By looking into this opening, you can observe whether or not a round is in the firearm's chamber. If a round is in the chamber, you should be able to see the cartridge rim through this opening.

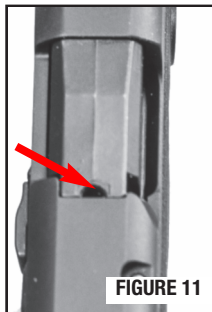

FIGURE 11

**WARNING: ALWAYS TREAT EVERY FIREARM AS IF IT IS LOADED AND WILL FIRE IF THE TRIGGER IS PULLED. A LOADED CHAMBER INDICATOR MAY HELP DETERMINE WHETHER THE CHAMBER IS LOADED OR UNLOADED. THE AMOUNT OF LIGHT, CLEANLINESS OF THE PISTOL, DISCOLORATION OF THE AMMUNITION AND OTHER FACTORS MAY LIMIT THE EFFECTIVENESS OF THE LOADED CHAMBER INDICATOR.**

## PREPARATION FOR FIRING

**WARNING: THE FAILURE TO FOLLOW THESE FIREARM SAFETY REQUIREMENTS WILL CAUSE SERIOUS PERSONAL INJURY OR DEATH TO YOU OR OTHERS.**

- **ALWAYS TREAT ALL FIREARMS AS IF THEY ARE LOADED.**
- **ALWAYS BE SURE THAT THE CHAMBER IS CLEAR OF A CARTRIDGE, THE MAGAZINE IS REMOVED OR UNLOADED, AND THAT THE FIREARM IS POINTING IN A SAFE DIRECTION.**
- **ALWAYS KEEP FINGERS AND OTHER PARTS OF YOUR BODY AWAY FROM THE MUZZLE AND AWAY FROM THE PISTOL SLIDE AND EJECTION PORT.**

---

## PREPARATION FOR FIRING CONTINUED

---

- **ALWAYS WEAR ADEQUATE AND PROPER HEARING PROTECTION SPECIFIED FOR FIREARM USE** to prevent permanent damage to your hearing. Make sure others who are nearby are wearing hearing protection as well.
- **ALWAYS WEAR SAFETY GLASSES SPECIFIED FOR FIREARM USE**, whether indoors or out. Safety glasses should protect your eyes from the firing flash and particles associated with the discharge of ammunition. Failure to do so creates a risk of personal injury from particle or debris spitting or a ricochet.
- **ALWAYS BE ALERT AND ALWAYS FOLLOW THE SAFETY INSTRUCTIONS OF THE RANGE OFFICER.** Never shoot if you are tired, cold or impaired in any way.
- **ALWAYS BE AWARE OF OTHER PEOPLE** so that any person does not accidentally walk into the line of fire.
- **THE SHOOTER (AND ALL OTHERS IN THE SHOOTING AREA) MUST ALWAYS BE IN A POSITION THAT IS OUT OF THE LINE OF FIRE** and are not within an area where they may be struck by a ricochet or particles spitting from a firearm, or by ejected cases from some types of firearms.
- **NEVER SHOOT AT SURFACES THAT MAY CAUSE A RICOCHET.** Always select a place to shoot that has a safe backstop, is free from obstructions and has no surfaces which may cause a ricochet.
- **NEVER FIRE RANDOMLY INTO THE SKY.** Always select a place to shoot that has a safe backstop.
- **NEVER USE ALCOHOL OR DRUGS BEFORE OR WHILE SHOOTING OR HANDLING ANY FIREARM.**

---

## LOADING

---



**WARNING: ALWAYS KEEP THE MUZZLE POINTED IN A SAFE DIRECTION.**



**WARNING: M&P® BODYGUARD® 380 PISTOLS WILL FIRE WITH THE MAGAZINE REMOVED. KEEP YOUR FINGER OFF THE TRIGGER AND OUTSIDE OF THE TRIGGER GUARD UNTIL YOU HAVE MADE THE COMMITMENT TO FIRE.**

- Do not load the pistol until you have read and fully understand this entire manual.
- Do not load the pistol until you are ready to use it. Keep your finger off the trigger and outside the trigger guard until you are ready to fire.



---

## LOADING CONTINUED

---

- Never load your pistol until you are sure of your target, what is beyond it and are fully prepared to fire.
- If the magazine is removed with a round left in the chamber, be sure to holster or otherwise safely secure the pistol under your direct control while the magazine is being reloaded.
- Smith & Wesson® has provided you with a magazine designed to operate in your specific model of pistol. While your magazine may be able to be inserted into another model pistol, it will only function properly in the specific model for which it was designed. Do not interchange magazines from one model pistol to another model pistol.
- Follow instructions in this manual and any other specific instructions which may be marked onto, or accompany, a magazine. Failure to use the particular type of Smith & Wesson® magazine specified for your model and caliber of pistol may result in a malfunction.
- Load the magazine by pressing a cartridge head (rear of cartridge) downward on the forward portion of the magazine follower (or downward on the case of the previously loaded cartridge) and sliding the magazine fully under the lips of the magazine until the cartridge head is against the rear wall of the magazine (FIGURE 12). Repeat the procedure for the number of cartridges you wish to load, up to the magazine capacity. Do not attempt to load your magazine with more than the specified number of cartridges because doing so can cause a feeding failure.
- Inspect your pistol as previously described in the “Inspecting Your Pistol” section. Hold the pistol in one hand with the muzzle pointing in a safe direction and with your finger off the trigger and outside the trigger guard. Insert the loaded magazine into the magazine well (opening) of the pistol until it is locked in place.

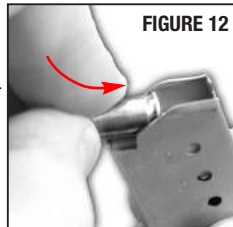

**WARNING: VERIFY THAT THE FIRING PIN IS NOT PROTRUDING FROM THE BREECH FACE. IF THE FIRING PIN IS PROTRUDING, DO NOT ATTEMPT TO LOAD OR FIRE THE FIREARM. BRING THE FIREARM TO A GUNSMITH QUALIFIED TO PERFORM SERVICE ON SMITH & WESSON® FIREARMS.**



**WARNING: DO NOT USE EXCESSIVE UPWARD FORCE WHEN INSERTING A LOADED MAGAZINE INTO THE PISTOL. EXCESSIVE UPWARD FORCE COULD CAUSE THE SLIDE TO MOVE FORWARD, CHAMBERING A ROUND AND MAKING THE PISTOL READY TO FIRE.**

---

## LOADING CONTINUED

---

- To make sure that the magazine is fully and securely inserted, apply some removal pressure to the exposed portion of the magazine floor plate.
- Pull the slide to the rear and then release it, allowing it to carry fully forward. This strips a cartridge from the magazine and seats it in the chamber of the barrel.



**WARNING: IF THE CARTRIDGE FAILS TO STRIP FROM THE MAGAZINE OR FULLY SEAT INTO THE CHAMBER, IMMEDIATELY STOP THE LOADING PROCESS.**

**REMOVE THE MAGAZINE, LOCK THE SLIDE OPEN AND VERIFY THAT THE CHAMBER IS EMPTY. REFER TO THE "INSPECTING YOUR PISTOL" SECTION OF THIS MANUAL.**



**WARNING: ALWAYS LOAD A ROUND INTO THE CHAMBER BY FEEDING IT FROM THE MAGAZINE. FAILURE TO FOLLOW THIS WARNING CAN RESULT IN SEVERE INJURY OR DEATH TO YOU OR OTHERS. NEVER ATTEMPT TO LOAD THE PISTOL BY INSERTING A ROUND INTO THE OPEN EJECTION PORT.**

**CAUTION:** The pistol can now be fired by pulling the trigger to the rear.

- If you wish to restore the magazine in your pistol to its full capacity, put the safety lever (if your pistol is so-equipped) fully upward in the SAFE position.
- Depress the magazine release and remove the magazine from the pistol. Remember that there is a round in the chamber; therefore, the weapon should be holstered or safely secured during this process without touching the trigger. Load one cartridge into the magazine to replace the one which was chambered when you allowed the slide to carry forward.
- Re-insert the loaded magazine into the magazine well of the pistol until it is locked in place. To make sure that the magazine is again fully and securely inserted, apply some removal pressure to the exposed portion of the magazine butt plate.
- Your pistol and its magazine are now fully loaded and will fire when the trigger is pulled. The safety lever (if your pistol is so-equipped) must be in the lowered FIRE position to allow the trigger to be pulled. Remember to keep your pistol pointed in a safe direction under all conditions and always keep your finger or any other object off the trigger and outside the trigger guard until you have made the commitment to fire the handgun. Never leave a loaded firearm out of your direct control.

---

# FIRING

---



**WARNING: ALWAYS KEEP THE MUZZLE POINTED IN A SAFE DIRECTION.**



**WARNING: UPON FIRING THE PISTOL OR RELEASING THE SLIDE FROM THE SLIDE STOP, THE SLIDE MOVES REARWARD OR FORWARD WITH SIGNIFICANT FORCE AND SPEED. TO AVOID INJURY, BE SURE NO PART OF YOUR BODY IS IN THE PATH OF THE SLIDE'S TRAVEL.**



**WARNING: WEAR EYE AND HEARING PROTECTION SPECIFIED FOR FIREARM USE EVERY TIME YOU DISCHARGE YOUR FIREARM. MAKE SURE OTHERS IN THE VICINITY OF WHERE YOU WILL BE SHOOTING DO SO AS WELL.**



**WARNING: "STAGING" THE TRIGGER VIOLATES A BASIC RULE OF FIREARM SAFETY WHICH WARNS YOU TO KEEP YOUR FINGER OUT OF THE TRIGGER GUARD UNTIL YOU HAVE MADE THE COMMITMENT TO FIRE. "STAGING" CREATES A SERIOUS RISK OF PERSONAL INJURY OR DEATH SINCE IT MAY LEAD TO AN UNINTENTIONAL DISCHARGE.**

- It has come to our attention that some users of Smith & Wesson handguns may stage the trigger in anticipation of firing a shot. Staging is the act of pulling the trigger rearward toward – stopping just short of – the point where the handgun fires. Such manipulation of the trigger can reduce the user's control of the handgun and can result in an unintentional discharge. Furthermore if the user decides not to fire, release of the trigger from a position close to the firing point in the staging process could result in an unintentional discharge.
- Keep the muzzle pointed in a safe direction and your finger outside the trigger guard until you are ready to fire. Each shot will be fired in double action mode. While holding the grip firmly, pull the trigger fully to the rear. As the trigger is drawn fully to the rear, the hammer assembly is cycled, striking the cartridge primer and firing the cartridge. Upon firing, the slide moves rearward, thereby extracting and ejecting the spent cartridge case. The slide then returns forward under spring pressure, feeding the next cartridge from the magazine into the barrel chamber.
- After firing a shot, you must allow the trigger to move fully forward before you can fire another shot. Failure to do so will prevent the lock work from fully cycling and will prevent your being able to fire the next shot. This sequence can be repeated until the last round has been fired, at which time the magazine follower exerts upward pressure on the slide stop causing it to engage the slide and to hold the slide in the "open" position.

## CLEARING MISFIRES



**WARNING: IF YOUR HANDGUN GIVES ANY INDICATION THAT IT IS NOT PERFORMING PROPERLY OR THE OPERATION OF YOUR HANDGUN HAS CHANGED “THE WAY IT FEELS OR SOUNDS”, STOP FIRING. MAKE SURE THE FIREARM IS POINTED IN A SAFE DIRECTION, UNLOAD THE FIREARM AND HAVE IT INSPECTED AND TEST- FIRED BY A GUNSMITH QUALIFIED TO PERFORM SERVICE ON SMITH & WESSON FIREARMS.**

- If a cartridge fails to fire, the chamber must be manually cleared.
- Wait ten seconds while keeping the muzzle pointed in a safe direction.
- Keep your finger off the trigger and out of the trigger guard.
- Remove the magazine (FIG.13).
- Grasp the serrated sides of the slide from the rear and briskly pull the slide fully rearward to eject the misfired round. Do not obstruct the ejection port, and do not attempt to catch the round by placing your hand over the ejection port (FIGURE 14).

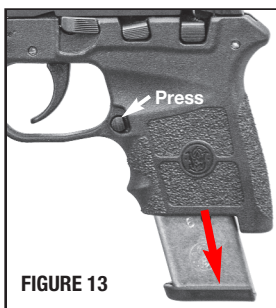

FIGURE 13



FIGURE 14



**WARNING: M&P® BODYGUARD®380 PISTOLS ARE DESIGNED TO BE ABLE TO FIRE WHEN THE MAGAZINE IS REMOVED. THEREFORE, IF THE MAGAZINE IS REMOVED FROM THE PISTOL AND THERE IS A LOADED ROUND IN THE CHAMBER, IT WILL FIRE IF THE TRIGGER IS PULLED.**

- After inserting a magazine into the pistol, test to make sure it is locked in place by applying some removal pressure to the exposed portion of the magazine butt plate.
- Lock the slide in the open position by allowing the slide to move slightly forward from the rearmost position while pressing upward on the slide stop.
- You are now able to safely check the barrel chamber and bore visually for any obstructions.

# UNLOADING



**WARNING: ALWAYS KEEP YOUR PISTOL POINTED IN A SAFE DIRECTION. ALWAYS KEEP YOUR FINGER OFF THE TRIGGER AND OUTSIDE THE TRIGGER GUARD WHEN UNLOADING.**

- Make sure your finger is off the trigger and out of the trigger guard. Depress the magazine release and remove the magazine (FIGURE 15).
- Point the muzzle in a safe direction, place the safety lever (if your pistol is so-equipped) in the lowered “FIRE” position to allow the slide to be moved rearward.
- Keep the muzzle still pointed in a safe direction, and keep your finger off the trigger and outside the trigger guard, grasp the serrated sides of the slide from the rear with the thumb and fingers, (FIGURE 16) and briskly draw the slide fully rearward in order to extract any cartridge from the barrel chamber and clear it from the pistol.
- Lock the slide in the open position by allowing the slide to move slightly forward from the rearmost position while pressing upward on the slide stop (FIGURE 17). Do not obstruct the ejection port because doing so can interfere with ejection of a cartridge. Visually check the barrel chamber to be sure it is empty.
- Look into the chamber and down through the magazine well. Verify that no ammunition remains in the pistol (FIGURES 18 and 19).
- Unload the magazine by holding it with the bullet end of the cartridge pointing away from you and pressing each cartridge forward and out of the magazine.

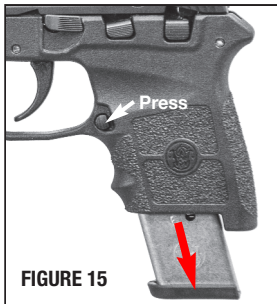

FIGURE 15



FIGURE 16



FIGURE 17



FIGURE 18

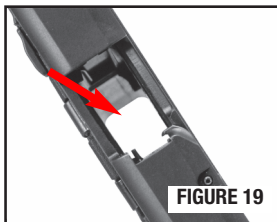

FIGURE 19

# FIELD STRIPPING / DISASSEMBLY



**WARNING: ALWAYS KEEP THE MUZZLE POINTED IN A SAFE DIRECTION.**



**WARNING: ALWAYS FOLLOW THE FIELD STRIPPING INSTRUCTIONS EXACTLY. NEVER DO ANYTHING BEYOND WHAT YOU ARE SPECIFICALLY INSTRUCTED TO DO IN THIS MANUAL. NEVER ALTER OR MODIFY THE PARTS IN YOUR PISTOL.**



**WARNING: WEAR SAFETY GLASSES EVERY TIME YOU ASSEMBLE OR DISASSEMBLE YOUR FIREARM.**

- Point the pistol in a safe direction. Make sure your finger is off the trigger and out of the trigger guard. Depress the magazine release and remove the magazine (FIGURE 20).
- Place the safety lever (if your pistol is so-equipped) into the down “fire” position to allow the slide to be moved rearward.
- Make certain that the chamber is clear. With the muzzle still pointing in a safe direction, and with your finger off the trigger and outside the trigger guard, grasp the serrated sides of the slide from the rear with the thumb and fingers (FIGURE 21) while holding the firearm in an upright position, and briskly draw the slide fully rearward in order to extract any cartridge from the barrel chamber and clear it from the pistol.
- Lock the slide open by holding the slide fully rearward and pressing up on the slide stop (FIGURE 22).
- Make certain that the firearm is clear of any ammunition (chamber and magazine well) (FIGURES 23 and 24).

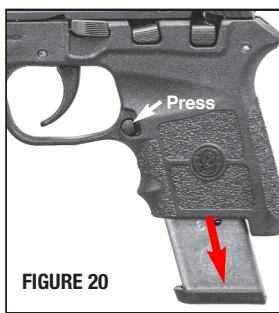

FIGURE 20



FIGURE 21



FIGURE 22



FIGURE 23

## FIELD STRIPPING DISASSEMBLY CONTINUED

- Rotate the takedown lever down past the 6 o'clock position (FIGURE 25).

**NOTE:** A non-marring tool such as a plastic pen may be needed to help rotate the takedown lever down (FIGURE 25).

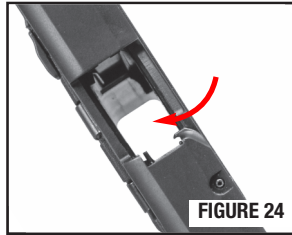

FIGURE 24

- Remove the takedown lever from the frame by grasping it and rotating it past the 9 o'clock position and pulling it out of the frame (FIGURE 26). Some wiggling of the takedown lever may be required to get it out of the frame.

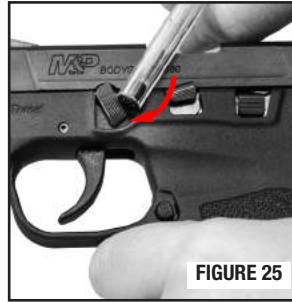

FIGURE 25

- Close the slide by grasping the serrated sides and drawing it rearward (FIGURE 27), until the slide stop disengages, then carefully allow the slide to move forward to its closed position.



FIGURE 26

- Remove the slide from the frame by pushing it forward with your thumb while being careful to retain the recoil spring and guide rod assembly (FIGURES 28 and 29).



**WARNING: DO NOT ALTER, MODIFY OR REPLACE ANY OF THE PARTS OF YOUR FIREARM UNLESS THIS WORK IS PERFORMED BY A QUALIFIED GUNSMITH USING GENUINE SMITH & WESSON® PARTS. IF YOU DO OTHERWISE, IMPROPER FUNCTIONING MAY OCCUR AND SERIOUS INJURY MAY RESULT.**



FIGURE 27



FIGURE 28

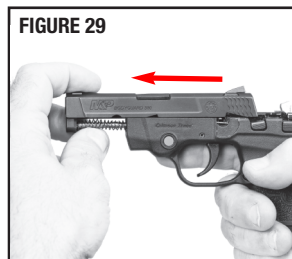

FIGURE 29

## FIELD STRIPPING DISASSEMBLY CONTINUED

**WARNING: NEVER DISASSEMBLE YOUR HANDGUN BEYOND THE FIELD STRIPPING PROCESS OUTLINED IN THIS MANUAL. NEVER MANIPULATE ANY INTERNAL COMPONENTS BEYOND WHAT YOU ARE SPECIFICALLY INSTRUCTED TO DO IN THIS MANUAL SINCE THIS MAY AFFECT THE RELIABILITY, FUNCTIONING AND SAFETY OF YOUR HANDGUN.**

**WARNING: THE RECOIL SPRING IS UNDER PRESSURE. CONTROL THE SPRING SO THAT IT DOES NOT FLY OUT AND CAUSE INJURY.**

- Retain control of the recoil spring when the slide is removed from the frame (FIGURE 30).
- Remove the recoil spring from the slide (FIG. 31).
- Remove the barrel from the slide (FIGURE 32).
- FIGURE 33 shows the pistol field stripped for cleaning and lubricating.



FIGURE 30

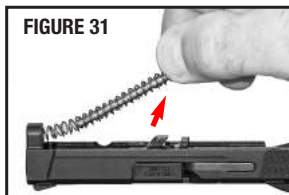

FIGURE 31



FIGURE 32



FIGURE 33

## LUBRICATION

- A single drop of firearm oil should be applied (FIGURES 34a and 34b). This will ensure proper lubrication. Care should be taken not to over-lubricate. Excess lubricant can collect quantities of powder residue, which could interfere with proper functioning of the pistol.

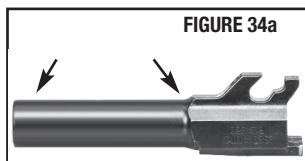

FIGURE 34a

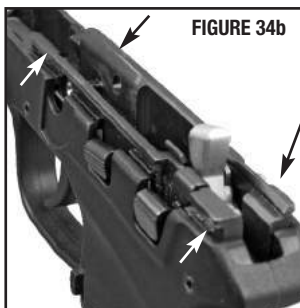

FIGURE 34b



# FIELD STRIPPING / ASSEMBLY



**WARNING: ALWAYS FOLLOW THE FIELD STRIPPING INSTRUCTIONS EXACTLY. NEVER DO ANYTHING BEYOND WHAT YOU ARE SPECIFICALLY INSTRUCTED TO DO IN THIS MANUAL. NEVER ALTER OR MODIFY THE PARTS IN YOUR PISTOL.**



**WARNING: WEAR SAFETY GLASSES EVERY TIME YOU ASSEMBLE OR DISASSEMBLE YOUR FIREARM.**

- With the bottom of the slide turned up, replace the barrel in the slide so the muzzle is flush with the end of the slide and the barrel lug is turned up (FIGURES 35 and 36).



- Install the recoil spring onto the guide rod, this will become the recoil guide rod assembly (FIGURE 37).

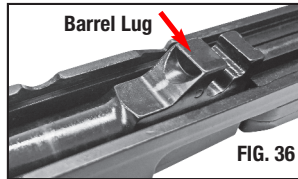

- Insert the small end of the recoil guide rod into the recoil guide rod hole in the slide once the spring and guide rod are together (FIGURE 38).

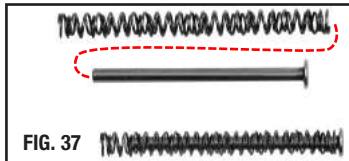

- Compress the assembly into the slide while lowering the rear of the guide rod into the notch in the barrel lug (FIGURE 39).

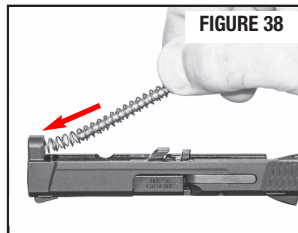

- Make sure that the recoil guide rod assembly is properly centered (FIGURE 40 and 41).

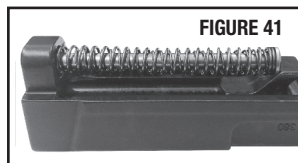
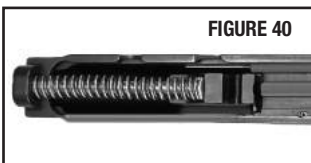
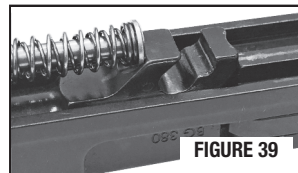

## FIELD STRIPPING / ASSEMBLY CONTINUED

- FIGURE 42 shows the recoil spring and guide rod in position against the barrel lug.



FIGURE 42

- While retaining the recoil spring assembly in position, push the slide assembly onto the frame rails of the pistol (FIG. 43).



FIGURE 43

- Continue to push the slide back and onto the frame rails (FIGURE 44) until you meet some resistance.



FIGURE 44

- Now, grasp the slide as shown and pull it fully rearward.

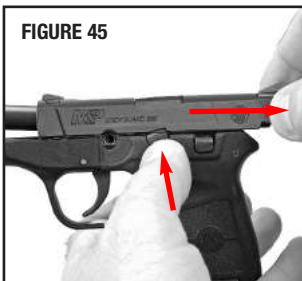

FIGURE 45

- While holding the slide fully rearward, lock the slide open by pressing up on the slide stop lever (FIGURE 45). While holding the slide stop up in the slide stop notch let the slide move forward slightly to engage the slide stop.

**NOTE:** Make sure the barrel is fully forward - protruding from the front of the slide (FIGURE 46). It may be necessary to grasp the barrel and move it forward until the lug allows clearance for the takedown lever to be inserted in the hole on the left side of the frame.



FIGURE 46

---

## FIELD STRIPPING / ASSEMBLY CONTINUED

---

- Once the slide is fully rearward and locked open, insert the takedown lever into the frame as shown (FIGURE 47).

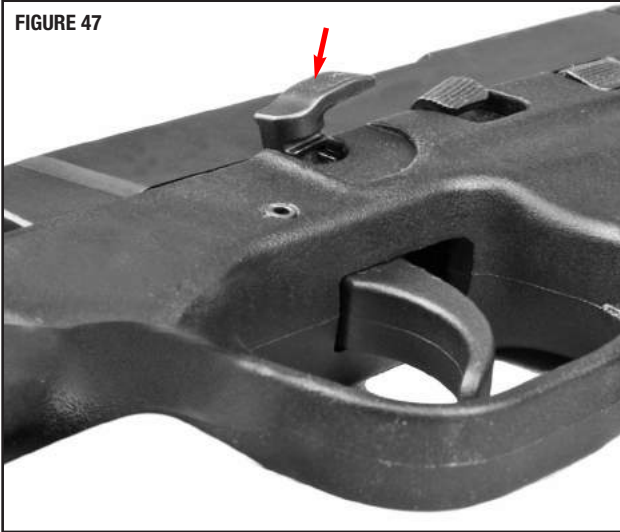
**FIGURE 47**

- Once the takedown lever is inserted into the hole in the frame, apply pressure inward on the takedown lever (and wiggle it if necessary) until it “clicks” into position against the frame in the orientation shown here (FIGURE 48).

**FIGURE 48**

- Close the slide by grasping the serrated sides and drawing it rearward, until the slide stop disengages from its, then allow the slide to move forward to its closed position (FIGURE 49).

**FIGURE 49**

---

## SIGHT ADJUSTMENT

---



**WARNING: ENSURE THAT YOUR PISTOL IS UNLOADED BEFORE ATTEMPTING TO ADJUST THE SIGHTS. FOLLOW THE BASIC FIREARMS SAFETY RULES IN THE SECTION ENTITLED “YOUR SAFETY RESPONSIBILITIES” AT ALL TIMES.**

- The open sights are adjustable for windage only. To adjust, move the rear sight in the direction you wish the group to move on the target. For example, if the group should move to the right, move the rear sight to the right. Use a brass or plastic drift or punch to prevent marring the rear sight (FIGURE 50).



# MAGAZINE



**WARNING: WEAR SAFETY GLASSES EVERY TIME YOU ASSEMBLE OR DISASSEMBLE YOUR MAGAZINE.**



**WARNING: THE MAGAZINE SPRING IS UNDER PRESSURE. CONTROL THE SPRING AND FOLLOWER SO THAT THEY DO NOT FLY OUT AND CAUSE INJURY.**

## MAGAZINE DISASSEMBLY

1. Using a drift punch, depress floor plate catch through the hole in the floor plate (FIGURE 51).
2. Slide floor plate off of the tube while holding floor plate catch in the tube (FIGURE 52).
3. Remove floor plate catch, spring and follower out through bottom of tube (FIGURE 53).

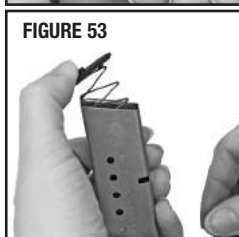

- FIGURE 54 shows the magazine parts in their disassembled state for clarity.

## MAGAZINE ASSEMBLY

1. Install magazine follower, spring and floor plate catch into the tube in exactly the same orientation as they were in when they were first removed during disassembly.

**NOTE:** The magazine spring is reversible (top to bottom) but when installing it into the magazine tube, keep the “uphill” slant toward the front of the magazine as shown (FIGURE 54).

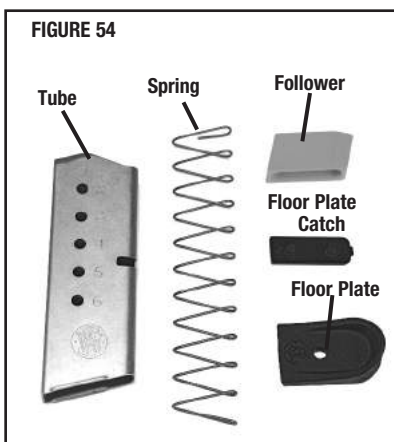

2. While holding floor plate catch in tube, slide floor plate onto tube so that the round projection of the floor plate catch engages the hole in the floor plate.

# MANUAL THUMB SAFETY

## For Those Models So-Equipped

Your M&P® BODYGUARD®380 pistol may be equipped with a manual thumb safety lever.



**WARNING: NEVER RELY ON MECHANICAL FEATURES ALONE. ONLY YOUR SAFE GUN HANDLING WILL ENSURE THE SAFE USE OF YOUR FIREARM. THIS IS YOUR RESPONSIBILITY.**



**WARNING: IT IS YOUR RESPONSIBILITY TO CONTINUOUSLY EXAMINE YOUR PERSONAL SITUATION TO PROVIDE A SUFFICIENT LEVEL OF SAFETY.**

- When the slide is closed and the manual thumb safety lever is fully up in the SAFE position it prevents the trigger from moving rearward to fire the pistol.
- The manual thumb safety lever also stops the slide from moving rearward when it is in the up SAFE position.

- With the slide fully forward, push the manual thumb safety lever fully upward to put it in SAFE position (FIGURE 55).



- The slide is locked in position when the safety lever is up in the SAFE position. The safety lever can only be moved up into the SAFE position when the slide is fully forward.

- When you are ready to fire the pistol, lower the thumb safety lever fully to put it in "FIRE" position (FIGURE 56). Now, when the trigger is pulled, the pistol will fire.



- The magazine can be removed and installed in the pistol regardless of the position of the safety lever.
- The slide can be manipulated to load (or unload) the chamber only when the manual safety lever is down in the "FIRE" position. Keep your finger away from the trigger unless you are in the act of firing.

---

# CLEANING AND MAINTENANCE

---



**WARNING: ENSURE THAT YOUR FIREARM IS UNLOADED BEFORE BEGINNING TO CLEAN IT. (SEE “INSPECTING YOUR FIREARM” SECTION).**

**ALWAYS FOLLOW THE RULES OF SAFE GUN HANDLING.**



**WARNING: WEAR SAFETY GLASSES EVERY TIME YOU ASSEMBLE OR DISASSEMBLE YOUR FIREARM AND ATTEMPT CLEANING OR MAINTENANCE.**

- Before using your firearm for the first time, it should be cleaned.
- Your firearm was treated at the factory with either a preservative or oil to protect it against corrosion during shipping and storage.
- Preservative and oil should be wiped from the bore, chamber and exposed areas using a clean swab or patch before using the firearm.

**CAUTION:** Never disassemble your firearm beyond the instructions in the Field Stripping and Inspection sections of this manual.

- Purchase cleaning supplies from your firearms dealer that are specifically designated for your type and caliber of firearm. Many suppliers offer these in kit form for your convenience.
- Follow the instructions provided with your cleaning supplies.

**NOTE:** A basic firearm cleaning kit should include: a brass bore brush and a cleaning jag of appropriate size for the bore being cleaned, high-quality gun cleaning solvent and gun oil/lubricant, cotton cleaning patches and a cleaning rod that is long enough to push the brush and jag completely through the barrel.

- Remove excessive firing residue from the bore and chamber using a properly fitted brass brush dipped in gun cleaning solvent. Finish the bore cleaning process by running a dry cotton cloth patch through the bore and chamber to remove residue and solvent.
- Clean the exterior of the firearm using a non-abrasive cleaning cloth.
- After cleaning, lightly coat the metal parts, internal and external, with a high-quality gun oil.
- Whenever your firearm has been exposed to sand, dust, extreme humidity, water or other adverse conditions, it must be cleaned and lubricated.

---

## CLEANING AND MAINTENANCE CONTINUED

---

 **WARNING: ALWAYS HAVE ADEQUATE VENTILATION. CLEANING FIREARMS IN POORLY VENTILATED AREAS, DISCHARGING FIREARMS, OR HANDLING AMMUNITION MAY RESULT IN EXPOSURE TO LEAD AND OTHER SUBSTANCES KNOWN TO CAUSE BIRTH DEFECTS, REPRODUCTIVE HARM, AND OTHER SERIOUS PHYSICAL INJURY. WASH HANDS THOROUGHLY AFTER EXPOSURE.**

**CAUTION:** Always follow the instructions provided with your gun cleaner and gun lubricant.

**CAUTION:** Some cleaners can cause damage to your firearms. You should avoid prolonged solvent immersion and prolonged ultrasonic cleaning of your firearm. Choice of solvent should be restricted to those products specifically developed for firearms maintenance. Damage to a firearm's finish may occur if these cautions are ignored. Ammoniated solvents or other strong alkaline solvents, should not be used on any Smith & Wesson® firearm.

- Cleaning is essential to ensure the proper functioning of your firearm.
- Your firearm is a precision instrument. To ensure reliable function it is necessary to follow a routine maintenance procedure. After firing your firearm, be sure to unload it following the procedure outlined in the section entitled "Inspecting Your Firearm" before performing any cleaning or maintenance procedure.
- Remove any gun cleaning solution, oil and fingerprints from the outside surfaces of the firearm. (Finger moisture, if left, could start a corrosion process).

 **WARNING: NEVER MANIPULATE, ADJUST OR CHANGE ANY OF THE INTERNAL COMPONENTS OF YOUR FIREARM UNLESS SPECIFICALLY DIRECTED TO DO SO IN THIS MANUAL. IMPROPER MANIPULATION OF ANY INTERNAL COMPONENT MAY AFFECT THE SAFETY AND RELIABILITY OF YOUR FIREARM AND MAY CAUSE SERIOUS INJURY OR DEATH.**

 **WARNING: ANY MAINTENANCE OR SERVICE NOT SPECIFIED IN THIS MANUAL MUST BE PERFORMED BY A QUALIFIED GUNSMITH USING GENUINE SMITH & WESSON® PARTS. IF YOU DO OTHERWISE, IMPROPER FUNCTIONING OF YOUR FIREARM MAY OCCUR AND SERIOUS INJURY OR DEATH MAY RESULT.**

- If your firearm will be used in a cold climate, be sure to use an oil of an appropriate weight so that it will not congeal in cold temperatures, causing the interaction of important parts to be slowed or halted.



---

## CLEANING AND MAINTENANCE CONTINUED

---

### MAINTENANCE BEFORE STORAGE -

- When storing, do not encase your firearm in anything that will attract or hold moisture, for example, leather or heavy cloth. Also, do not store guns with a plug inserted in the barrel for this can be a contributing factor to moisture accumulation. If your firearm is to be stored for an extended period, the bore, chambers and internal working mechanism should be oiled with a high quality lubricating oil or preservative intended for firearms. The external working mechanisms and barrel should be coated with an anti-rust oil. Before using your firearm again, be sure to clean it. Every time you clean your firearm, check it for signs of wear. If wear is noted, do not use the firearm. Return it to Smith & Wesson® for service or have it checked by a qualified gunsmith.

---

# LIMITED WARRANTY FOR THE M&P® BODYGUARD® 380 PISTOL

For Owners Within The United States.

---

This warranty is granted by Smith & Wesson Corp. This warranty is effective from the date of purchase and applies to the original owner of any firearm. With respect to such firearms, this warranty supersedes any and all other warranties.

Smith & Wesson firearms are warranted to be free from defects in material and workmanship. Any such defects of which Smith & Wesson receives written notice within one year from the date of purchase by the original owner, will be remedied by Smith & Wesson without charge within a reasonable time after such notification and delivery of the firearm as provided below.

In the event of an emergency (repairs needed by law enforcement, an upcoming match or hunting trip), call 1-800-331-0852, ext. 4125 and ask for 911 Priority Repair Service. This allows you to speak with a Smith & Wesson representative. Immediately upon receipt, your firearm will be assigned to a gunsmith. After the work is completed, we will return your Smith & Wesson firearm via overnight delivery.

To submit a warranty claim please see the "Contact and Shipping Information" below for details. In addition to the requested information, please include a copy of the bill of sale in the owner's name, or a copy of the BATFE Form 4473 indicating date of purchase. It is always important that the owner comply with all applicable federal, state and local laws and regulations.

---

## LIMITED WARRANTY CONTINUED

---

Warranty claims should state the model and serial number of the firearm concerned and the description of the difficulty experienced. It is recommended that shipments be insured by the owner, since Smith & Wesson will accept no responsibility for loss or damage in transit. Transportation and insurance charges for return to owner will be paid by Smith & Wesson if the claim is covered by the warranty.

UNDER NO CIRCUMSTANCES SHALL SMITH & WESSON BE RESPONSIBLE FOR INCIDENTAL OR CONSEQUENTIAL DAMAGES WITH RESPECT TO ECONOMIC LOSS, INJURY, DEATH OR PROPERTY DAMAGE, WHETHER AS A RESULT OF BREACH OF THIS WARRANTY, NEGLIGENCE OR OTHERWISE.

Some states do not allow the exclusion or limitation of incidental or consequential damages, so the above limitation or exclusion may not apply to you.

Smith & Wesson will not be responsible for:

- Defects or malfunctions resulting from careless handling, unauthorized adjustments or modifications made or attempted by anyone other than a qualified gunsmith following Smith & Wesson authorized procedures, or failure to follow the disassembly instructions in the Smith & Wesson manual.
- Use of defective or improper ammunition, corrosion, neglect, abuse, ordinary wear and tear, or unreasonable use.
- Criminal misuse, negligence or use under the influence of drugs or alcohol.

Smith & Wesson's Lifetime Service Policy begins after the warranty period has expired. Smith & Wesson will repair, without charge, for the lifetime of the original owner, any Smith & Wesson handgun purchased on or after February 1, 1989, and any M&P15 series rifle, that is found to have a defect in material or workmanship. Eligibility for this Lifetime Service Policy requires returning the Product Registration Card within 30 days of purchase. The Lifetime Service Policy covers functional defects; it does not include the firearm's finish, grips, magazines or sights. The Lifetime Service Policy is in addition to and not an extension of the Smith & Wesson Warranty.

This warranty gives you specific legal rights. You may also have other rights that vary from State to State.

**NOTE:** All liability is excluded in the event that the instructions in the Smith & Wesson manual are not observed.

# CONTACT AND SHIPPING INFORMATION

For Owners Within The United States

**NOTE:** A Return Merchandise Authorization (**RMA**) is the first step in the process of returning a product in order to receive a repair, replacement or refund. Please contact Smith & Wesson's Customer Service Dept. (via e-mail: [qa@smith-wesson.com](mailto:qa@smith-wesson.com) or by phone at 800-331-0852 ext. 4125) to obtain authorization to return your firearm so we can process it quickly and efficiently. The RMA number that is supplied by Smith & Wesson® must be displayed on the outside of the returned product's packaging; returns without an RMA number will be routed differently which will result in delayed processing.

The issuance of an Return Merchandise Authorization (**RMA**) allows Smith & Wesson® an opportunity to try to diagnose and correct a customer's concerns with the product (such as ammunition problems) before it is returned. Accordingly, please contact us before returning your Smith & Wesson firearm.

## **CONTACT CUSTOMER SERVICE**

Tel: 800-331-0852 ext. 4125

E-mail: [qa@smith-wesson.com](mailto:qa@smith-wesson.com)

## **RETURNS - FOR SERVICE**

### **ALL SMITH & WESSON FIREARMS**

Smith & Wesson  
2100 Roosevelt Avenue  
Springfield, MA 01104

Should your Smith & Wesson® firearm require service, it should be returned to the Smith & Wesson® factory.

- Call or e-mail the Customer Service Dept. for authorization and shipping instructions.
- Ensure that the firearm is unloaded.
- **Do not attempt to ship a firearm via US Postal Service; only federally licensed dealers may ship a firearm by US Postal Service.**
- **DO NOT SHIP ANY AMMUNITION.**

---

## CONTACT AND SHIPPING CONTINUED

---

- Enclose a letter which includes your full name and address (no P.O. Boxes, please), daytime telephone number, e-mail address, the serial number of the firearm, and details of the problem experienced (stating the brand and type of ammunition used when the problem occurred) or work desired.
- Record the serial number before shipping, in case you wish to check on the repair status of your firearm.
- Please remove all custom parts and accessories, such as stocks, special sights and scopes, or slings from your firearm before returning.
- Place the firearm in its original case or in a similarly secure container and pack it securely.
- The package must **NOT** bear any markings which indicate the identity of the contents.
- It is most important that you comply with federal, state, and local laws and regulations. The following guidelines are meant to help, but you must seek assistance from the appropriate authorities if necessary.
- If your firearm must be replaced, it may be necessary to ship the replacement to a dealer rather than directly to you. You will be requested to furnish a signed FFL (Federal Firearms License) from your dealer in such an instance.
- Warranty repair work will begin upon receipt and examination of the firearm. In the case of repairs or work not covered by the warranty, a quotation covering the cost of the work plus round trip transportation charges will be sent to you. Repairs or modification will be scheduled upon receipt of payment.
- A parts list can be obtained by contacting Smith & Wesson® Customer Service.



**WARNING: YOU MAY PURCHASE ACCESSORIES FOR YOUR SMITH & WESSON FIREARM. YOU MUST HAVE SOME OF THESE PARTS INSTALLED BY A GUNSMITH QUALIFIED TO PERFORM SERVICE ON SMITH & WESSON FIREARMS. YOU MUST NEVER ATTEMPT TO MODIFY YOUR FIREARM OR INSTALL REPLACEMENT PARTS IN YOUR FIREARM. ALWAYS USE A QUALIFIED SMITH & WESSON GUNSMITH EVEN IF THE REPAIR SEEMS SIMPLE.**

---

## CUSTOM SERVICE

---

- We understand that Smith & Wesson® gun owners may want to enhance their guns with custom gunsmithing, refinishing or accessories. Our gunsmiths offer specialized services and exclusive products to enhance your shooting experience.
- Accessories for your Smith & Wesson® firearm are available from your local Smith & Wesson® Stocking Dealer, or directly from Smith & Wesson®.
- Contact the Customer Service Department at 1-800-331-0852, ext. 4125 for information about these services.

When ordering directly from the factory, please provide the following information:

- Model Number
- Dash Number
- Serial Number
- Approximate date of purchase
- Complete Return Address
- VISA/Discover/MasterCard Number & Expiration Date
- For Foreign Orders Only, Fax Number or E-mail Address

---

# INTERNATIONAL WARRANTY CENTERS

For Owners Outside The United States

---

**NOTE:** Addresses and contact information for International Warranty Centers is available on the Smith & Wesson website at **[www.smith-wesson.com](http://www.smith-wesson.com)** or by calling Customer Service toll-free at 1-800-331-0852 ext 4125.

---

## PATENT INFORMATION

---

- This product may be covered by one or more patents. Visit **[www.smith-wesson.com](http://www.smith-wesson.com)** for virtual patent information.

**This handgun is not equipped with a device that fully blocks use by unauthorized users. More than 200,000 firearms like this one are stolen from their owners every year in the United States. In addition, there are more than a thousand suicides each year by younger children and teenagers who get access to firearms. Hundreds more die from accidental discharge. It is likely that many more children sustain serious wounds or inflict such wounds accidentally on others. In order to limit the chance of such misuse, it is imperative that you keep this weapon locked in a secure place and take other steps necessary to limit the possibility of theft or accident. Failure to take reasonable preventative steps may result in innocent lives being lost, and in some circumstances may result in your liability for these deaths.**

The certification below is required only for handguns sold in the United States with a barrel length shorter than 3".

Smith & Wesson Corp. hereby certifies average accuracy test results for all new handguns with a barrel shorter than 3" as follows:

7 yards	14 yards	21 yards
1.7"	3.9"	6.3"

This certification is based on tests conducted by Smith & Wesson Corp. using a fixed handgun, rest and firing ammunition manufactured by a member of the Shooting Arms and Ammunition Manufacturers Institute (SAAMI) as defined in ANSI/SAAMI Z299.3-1993.

This certification represents actual tests based on several handguns, selected at random. Your particular handgun may have accuracy better than the results stated in this certification.

# APPENDIX “A”

## INTEGRATED CRIMSON TRACE® LASER

(if pistol is so-equipped)

### OPERATOR MANUAL FOR LX-380 INTEGRATED CRIMSON TRACE® LASER IN THE M&P® BODYGUARD®380 Pistol

**WARNING: ALWAYS KEEP YOUR FIREARM POINTED IN A SAFE DIRECTION. ALWAYS TREAT EVERY FIREARM AS IF IT IS LOADED AND WILL FIRE. DO NOT TAKE ANYONE’S WORD THAT THE FIREARM IS UNLOADED – ALWAYS CHECK FOR YOURSELF.**

**WARNING: ENSURE THAT YOUR FIREARM IS UNLOADED BEFORE ATTEMPTING ANY ADJUSTMENT, CLEANING OR MAINTENANCE TO INTEGRATED THE CRIMSON TRACE® LASER. ALWAYS FOLLOW THE RULES OF SAFE GUN HANDLING.**

## INTEGRATED CRIMSON TRACE® LASER OPERATION

- This appendix is intended for use by operators of the M&P® BODYGUARD®380 Integrated Crimson Trace® laser (when the pistol is so-equipped). It provides a system description, operational procedures, and maintenance responsibilities. Complete familiarization with this manual prior to using the equipment will ensure safe operation and maximum effectiveness of the Integrated Crimson Trace® laser.

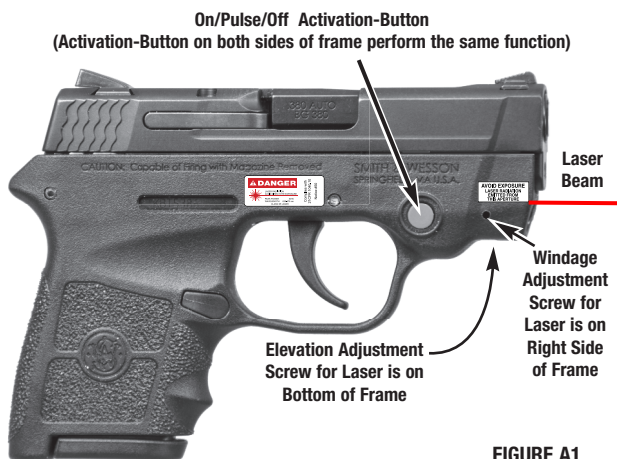



---

## INTEGRATED CRIMSON TRACE® LASER OPERATION CONT'D

---

**MODEL NUMBER & EQUIPMENT NAME:** LX-380  
M&P® BODYGUARD®380 Integrated Crimson Trace® Laser  
**MANUFACTURER:** Crimson Trace Corporation  
9780 SW Freeman Dr., Wilsonville, OR 97070 USA  
Tel: (800) 442-2406 Fax: (503) 783-5334  
crimsontrace.com

**PURPOSE OF EQUIPMENT:** The Integrated Crimson Trace® laser is a FDA Class IIIa (IEC Class 3R) laser product that emits visible light for precise aiming of the M&P® BODYGUARD®380 pistol.

The Integrated Crimson Trace® laser provides for active target acquisition in low light and close quarters situations and features ambidextrous laser controls, three operating modes, and a five minute auto-off timer.

---

## INTEGRATED CRIMSON TRACE® LASER BATTERIES

---



**WARNING: DO NOT USE THE INTEGRATED CRIMSON TRACE® LASER WITH A MIX OF OLD AND NEW BATTERIES, OR BATTERIES OF DIFFERENT BRANDS – RISK OF FIRE, EXPLOSION AND BURNS.**

**CAUTION:** Do not store the Integrated Crimson Trace® laser with the batteries installed for extended periods of time without testing periodically during such periods of non-use to ensure that it is functioning properly. When anticipating use of and reliance upon the Crimson Trace® laser, check beforehand to ensure it is in proper working order.

- **Battery Inspection:** The Integrated Crimson Trace® laser is powered by two (2) 357 silver oxide batteries (or equivalent). Before installation, inspect the batteries for any cracks, dents, leakage, or bulging. Never install a defective battery in the Integrated Crimson Trace® laser.

**NOTE:** Replacing batteries once a year is recommended. Any battery has the potential to leak harmful chemicals that can damage skin, clothing, or the inside of the Crimson Trace® laser. To avoid risk of injury, the following safety precautions apply when handling, storing, or disposing of batteries:

- Do not short circuit, puncture, incinerate, or disassemble.
- Do not attempt to recharge the batteries.
- Prior to use, inspect all batteries for cracks, dents, leakage, or bulging. Never install a defective battery in the Integrated Crimson Trace® laser.

## INTEGRATED CRIMSON TRACE® LASER BATTERIES CONT'D

- Performance of the batteries will vary depending on actual environmental conditions. Check beforehand to ensure that the laser is in proper working order.

**NOTE:** Proper functioning of the Crimson Trace® laser is dependent upon fully charged batteries. Batteries typically last 4 hours of actual "ON" time under normal intermittent use. If the laser becomes dim or fades, replace the batteries.

**NOTE:** Dispose of all depleted batteries in accordance with applicable federal, state, and local environmental regulations.

## INTEGRATED CRIMSON TRACE® LASER SAFETY PRECAUTIONS



**WARNING: VISIBLE LASER RADIATION EMITS FROM THE INTEGRATED CRIMSON TRACE® LASER WHILE IN OPERATION – AVOID DIRECT EYE EXPOSURE.**

- **DO NOT STARE INTO THE LASER BEAM.**
- **DO NOT LOOK INTO THE LASER BEAM THROUGH BINOCULARS OR TELESCOPES.**
- **DO NOT POINT THE LASER BEAM AT MIRROR-LIKE SURFACES.**
- **DO NOT SHINE THE LASER BEAM INTO ANOTHER INDIVIDUAL'S EYES.**

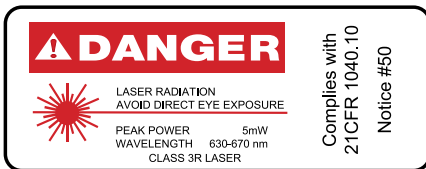

### PRODUCT SPECIFICATIONS:

- **BEAM INTENSITY:** 5mW peak, Class 3R laser
- **DOT SIZE:** Approximately 0.5 inches diameter at 50 feet
- **BATTERIES:** Two (2) 357 silver oxide batteries; over 4 hours of continuous on time
- **ACTIVATION:** Instant Activation - on/pulse/off activation-button with auto shut off at five minutes
- **WARRANTY:** One-year full warranty
- This product complies with 21 CFR 1040.10



**WARNING: DO NOT USE THE CRIMSON TRACE® LASER IN ENVIRONMENTS CONTAINING AN EXPLOSIVE ATMOSPHERE OR IN AREAS WHERE GASOLINE, PAINTS, SOLVENTS, OR OTHER FLAMMABLE LIQUIDS ARE STORED.**

## INTEGRATED CRIMSON TRACE® LASER PRECAUTIONS CONT'D

Before use, inspect all pieces of equipment for any damage such as cracks, loose parts, or other visible defects. If any damage or defects are noted:

### CONTACT SMITH & WESSON CUSTOMER SERVICE

Tel: 800-331-0852 ext. 4125

E-mail: qa@smith-wesson.com

### RETURNS FOR SERVICE -

FOR ISSUES INVOLVING THE LASER SIGHTING DEVICE:

**Smith & Wesson**

**Customer Service Department**

**2100 Roosevelt Avenue,**

**Springfield, Massachusetts 01104**

## INTEGRATED CRIMSON TRACE® LASER REMOVE AND INSTALL



**WARNING: ENSURE YOUR FIREARM IS UNLOADED BEFORE ADJUSTMENT OF THE INTEGRATED CRIMSON TRACE® LASER. AT ALL TIMES FOLLOW THE BASIC FIREARMS SAFETY RULES IN THE SECTION ENTITLED "YOUR SAFETY RESPONSIBILITIES".**

- The Integrated Crimson Trace® laser must be removed from the firearm before inspecting, cleaning, replacing batteries, or performing other maintenance functions.

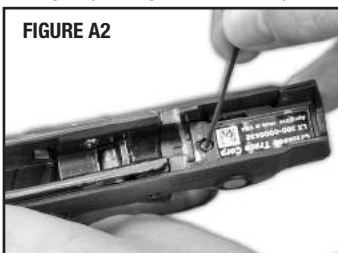

**FIGURE A2**

- Follow the instructions in the Field Stripping / Disassembly Section of this manual to remove the slide from the frame.
- Using the hex wrench provided, turn the screw at the rear of the laser housing counterclockwise until the screw disengages from the frame of the M&P® BODYGUARD®380 (FIGURE A2) - The screw remains captive in the laser housing and won't come out.



**FIGURE A3**

- Ensure the captive screw is slightly raised from the laser housing. (FIGURE A3). Using a small screwdriver, or similar tool, gently pry the laser mechanism up at the rear and tip it forward as shown in FIGURE A4.

## INTEGRATED CRIMSON TRACE® LASER REMOVE/INSTALL CONT'D

- Pull the laser assembly up and out of its seating cavity (FIGURE A4). Once it's tipped up the laser unit can be lifted clear of the frame.



FIGURE A4

- Install two (2) 357 silver oxide batteries as shown (FIGURE A5). Proper battery orientation is clearly marked on the battery pocket of the Crimson Trace® laser.

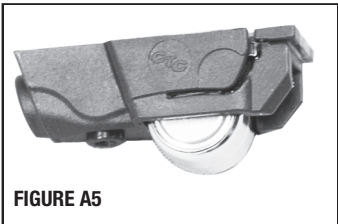

FIGURE A5

### INSTALL THE INTEGRATED CRIMSON TRACE® LASER INTO THE M&P® BODY-GUARD® 380 PISTOL.

- With the lens pointing toward the front of the pistol frame - insert the laser into the round hole and tip the laser into position (FIGURES A6 and A7).



FIGURE A6

- Seat the laser fully into its recess and tighten the hex screw to lock it into place (FIGURE A8).

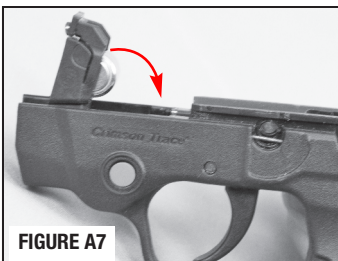

FIGURE A7

- Reassemble the pistol as detailed in the Field Stripping / Assembly Section of this manual.

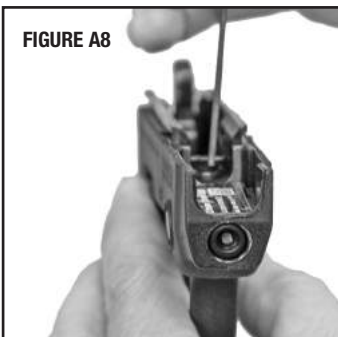

FIGURE A8

## INTEGRATED CRIMSON TRACE® LASER ACTIVATION BUTTON(S)



**WARNING: VISIBLE LASER RADIATION EMITS FROM THE INTEGRATED CRIMSON TRACE® LASER WHILE IN OPERATION – AVOID DIRECT EYE EXPOSURE.**

- The activation-button (to turn the laser on and off) is located at the front of the pistol frame (on both sides) (FIGURE A8).



- The table below illustrates modes of operation for the Crimson Trace® laser and the input required to activate them.

ON/PULSE/OFF ACTIVATION-BUTTON TABLE		
Activation-Button Behavior		
Mode	User Input	Result
On	Push Button 1x	Constant Laser
Pulse	Push Button 2x	Pulse Laser
Off	Push Button 3x	Off

- The Crimson Trace® laser is equipped with a five minute auto-off timer. After five minutes ( $\pm 15$  seconds) of continuous activation, the laser will begin to flash. This is true even if the Crimson Trace® laser is being operated in Pulse Mode.

# INTEGRATED CRIMSON TRACE® LASER ADJUSTMENT AND ZEROING



**WARNING: ENSURE YOUR FIREARM IS UNLOADED BEFORE ADJUSTING YOUR SIGHT. AT ALL TIMES FOLLOW THE BASIC FIREARMS SAFETY RULES IN THE SECTION ENTITLED “YOUR SAFETY RESPONSIBILITIES”.**



**WARNING: VISIBLE LASER RADIATION EMITS FROM THE INTEGRATED CRIMSON TRACE® LASER WHILE IT IS IN OPERATION – AVOID DIRECT EYE EXPOSURE.**

- The Crimson Trace® laser is equipped with adjustment screws for independent movement of the laser beam for both windage and elevation. Adjustment screws can be turned using the provided hex wrench.
- Laser Adjustment Table (below): This table shows the direction of adjuster rotation (as viewed from above and behind the firearm) and the resultant direction of the laser beam and the shot group movement.

LASER ADJUSTMENT TABLE			
Windage or Elevation	Adjustment Screw Rotation	Laser Beam Movement	Shot Group Movement
Windage Adjustment	Clockwise	Right	Left
	Counter-Clockwise	Left	Right
Elevation Adjustment	Clockwise	Down	Up
	Counter-Clockwise	Up	Down

## ZEROING PROCEDURE

The Crimson Trace® laser is factory preset to be nearly parallel with the barrel of the firearm and is pre-sighted at 25'. It is ready to be zeroed at any distance via live fire.



**WARNING: ALWAYS BE SURE OF YOUR TARGET AND WHAT IS BEYOND IT WHEN FIRING.**

**CAUTION:** One complete rotation of the adjustment screws in either direction provides ample beam movement for zeroing purposes. *Turning the adjustment screws more than one complete rotation in either direction may result in damage to the Crimson Trace® laser.*

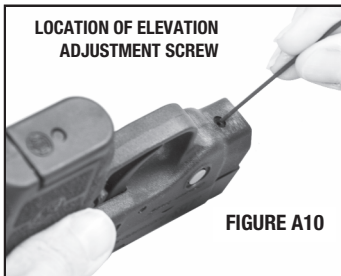

## INTEGRATED CRIMSON TRACE® LASER ADJUSTMENT AND ZEROING CONTINUED

**NOTE:** Direct sunlight may hinder the ability of the user to effectively see the laser beam on the target.

- Mount a target with a clearly visible aiming point down range at the desired zeroing distance.
- Turn ON the Crimson Trace® laser by pressing the activation-button once.
- While aiming the M&P® BODYGUARD®380 with its iron sights, rotate the adjustment screws as needed to superimpose the laser strike point over the M&P® BODYGUARD®380's aiming point (FIGURE A11). To determine the required direction of rotation, refer to the Laser Adjustment Table on page 46.

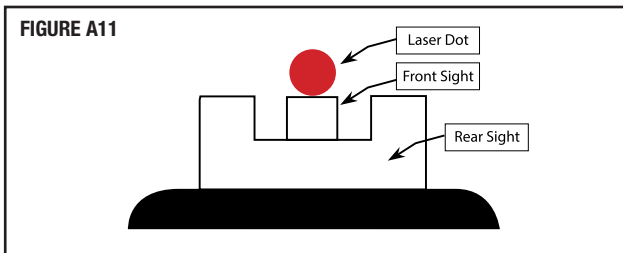

- Direct the Crimson Trace® laser at the target aiming point.
- Fire a 3-round shot group and note the center of the shot group relative to the target aiming point.
- Rotate the adjustment screws as needed to move the center of the shot group to the target aiming point. To determine the required direction of rotation, refer to the Shot Group Movement column in the Laser Adjustment Table on page 46.
- Fire another 3-round shot group to confirm zero.
- Repeat these steps until the shot group falls within an acceptable radius around the target aim point.
- The Crimson Trace® laser is now zeroed to the M&P® BODYGUARD®380. Press the activation-button twice to turn the laser OFF.

**NOTE:** As with any sighting device, the location of the shot group is dependent on distance to the target. A group that is shot using the laser aiming point at one distance will not necessarily be aligned with the aiming point at a different distance. The user needs to become familiar with the trajectory of the round being used and adjust accordingly.

---

# INTEGRATED CRIMSON TRACE® LASER MAINTENANCE

---



**WARNING: ENSURE YOUR FIREARM IS UNLOADED BEFORE PERFORMING MAINTENANCE ON YOUR INTEGRATED CRIMSON TRACE® LASER. AT ALL TIMES FOLLOW THE BASIC FIREARMS SAFETY RULES IN THE SECTION ENTITLED "YOUR SAFETY RESPONSIBILITIES".**

**NOTE:** Remove the Crimson Trace® laser from the M&P® BODY-GUARD®380 before inspecting, cleaning or performing other maintenance functions.

The Crimson Trace® laser should be inspected before each use and after prolonged periods of non-use. The following procedures will prolong the life of the laser and help ensure safe operation. Crimson Trace® laser sights require minimal attention and are designed to resist most common firearm chemicals and lubricants, however, excessive exposure to these chemicals can be detrimental. To ensure the safe and effective operation of your laser sights:

- Remove laser sight before cleaning gun.
- Do not use pressurized or compressed air.
- Do not immerse in cleaning fluid or lubricant. Oil will foul the lens of the laser and result in an unfocused beam. Clean the lens if it becomes covered with oil.
- Do not allow cleaning solution to enter lens source.
- Do not allow solvents to contact your laser that contain: VOCs or TCE such as: carburetor/brake cleaner, acetone, MEK, gasoline. Damage will result.
- Crimson Trace® diodes are designed and positioned to minimize exposure. Occasional cleaning of the lens is recommended. After extensive shooting, you may notice a degradation of beam quality or "beam spread". This is the result of fouling on the lens surface. This is normal and can be easily cleaned with the included cleaning swabs or a small cotton swab dipped in isopropyl alcohol or window cleaner.

Dry the lens with a clean dry swab. When cleaning the lens do not touch lens with any sharp objects.

**Batteries:** Inspect the batteries for cracks, dents, leakage or bulging. If a battery shows signs of damage, remove and dispose of properly. Replace batteries as required per battery handling section of this appendix.

**Laser Aperture:** The laser aperture may be cleaned using a soft cloth and water, alcohol or general purpose window cleaner. When cleaning the aperture do not touch with a sharp object that might scratch the surface.



---

# INTEGRATED CRIMSON TRACE® LASER LIMITED WARRANTY

---

Crimson Trace® Corporation (CTC) warrants that the LX-380 laser product on the M&P® BODYGUARD®380 pistol will be free from defects in materials and workmanship for a period of twelve (12) months from the date of purchase by the original owner. At its sole discretion, CTC will either repair or replace, at no charge, any LX-380 laser product or part (with the exception of the batteries) which is found to be defective, under normal use and service, during the warranty period. CTC's obligation to either repair or replace shall be the owner's sole and exclusive remedy under this warranty. This warranty does not cover normal maintenance and service and does not apply to any products or parts that have been subject to modification, misuse, carelessness, accident, improper maintenance or repair other than by CTC.

This warranty also does not cover damage caused by faulty batteries. The battery manufacturer should be contacted in the event of a leak.

Warranty claims (in writing) and the laser product concerned should be delivered to:

**Smith & Wesson  
Customer Service Department  
2100 Roosevelt Avenue,  
Springfield, Massachusetts 01104**

In addition, a copy of the bill of sale in the owner's name must be included. It is important that the owner comply with all applicable federal, state and local laws and regulations in the shipment of any firearm that is included with a laser product.

Warranty claims should state the serial number (if any) of the laser product and of the firearm included with the laser product, and include a description of the difficulty experienced with the laser product. It is recommended that shipments be insured by the owner, since neither CTC nor Smith & Wesson® Corp. will accept any responsibility for loss or damage in transit.

This limited warranty extends only to the original owner of the LX-380 laser product and there are no other warranties, expressed or implied other than as set forth in this limited warranty. CTC disclaims any warranties of merchantability and fitness for a particular purpose.

UNDER NO CIRCUMSTANCES SHALL CTC BE RESPONSIBLE FOR ANY INCIDENTAL, CONSEQUENTIAL OR SPECIAL DAMAGES ARISING OUT OF OR IN CONNECTION WITH PRODUCT USE OR PERFORMANCE, BREACH OF WARRANTY, NEGLIGENCE, OR OTHERWISE.

---

## INTEGRATED CRIMSON TRACE® LASER WARRANTY CONT'D

---

Some states do not allow the exclusion or limitation of incidental or consequential damages, so the above limitation or exclusion may not apply to you.

**NOTE:** All liability is excluded in the event that the instructions in this Appendix – “A” Operator Manual For The LX-380 laser on the M&P® BODYGUARD®380 Pistol are not observed.

---

## INTEGRATED CRIMSON TRACE® LASER SERVICE AND REPAIR

---

### CONTACT SMITH & WESSON CUSTOMER SERVICE

Tel: 800-331-0852 ext. 4125

E-mail: qa@smith-wesson.com

### RETURNS FOR SERVICE - FOR ISSUES INVOLVING THE LASER SIGHTING DEVICE

Smith & Wesson  
2100 Roosevelt Avenue  
Springfield, MA 01104

Should your laser-equipped Smith & Wesson® firearm require service specific to the laser device, it should be returned to the Smith & Wesson® factory.

- Call or e-mail the Customer Service Dept. for authorization and shipping instructions. TEL.: 1-800-331-0852, ext. 4125  
E-mail: qa@smith-wesson.com
- Ensure that the firearm is unloaded.
- **Do not attempt to ship a firearm via US Postal Service; only federally licensed dealers may ship a firearm by US Postal Service.**
- **DO NOT SHIP ANY AMMUNITION.**
- Enclose a letter which includes your full name and address (no P.O. Boxes, please), daytime telephone number, e-mail address, the serial number of the firearm, and details of the problem experienced (stating the brand and type of ammunition used when the problem occurred) or work desired.
- Record the serial number before shipping, in case you wish to check on the repair status of your firearm.

---

## INTEGRATED CRIMSON TRACE® SERVICE AND REPAIR CONT'D

---

- Please remove all custom parts and accessories, such as stocks, special sights and scopes, or slings from your firearm before returning.
- Place the firearm in its original case or in a similarly secure container and pack it securely.
- The package must **NOT** bear any markings which indicate the identity of the contents.

---

## INTEGRATED CRIMSON TRACE® LASER LEGAL INFORMATION

---

The exportation of this product falls under the jurisdiction of the U.S. Commerce Department Bureau of Industry and Security and is subject to the Export Administration Regulations.

The LX-380 laser is designed and produced by:  
Crimson Trace Corporation, Wilsonville, Oregon, USA  
[www.crimsontrace.com](http://www.crimsontrace.com)



**WARNING: THIS PRODUCT CONTAINS CHEMICALS KNOWN TO THE STATE OF CALIFORNIA TO CAUSE CANCER, OR BIRTH DEFECTS OR OTHER REPRODUCTIVE HARM.**

Crimson Trace® holds several patents and may have other patents pending that cover its innovations. Please review individual products for patent numbers to determine the specific patent coverage.

Crimson Trace® trademarks are property of Crimson Trace Corporation, Portland, Oregon, and are used by permission

# BATTERY WARNINGS



**WARNING: IF A BATTERY OPERATED ACCESSORY OR ATTACHMENT (I.E. LASER, OPTICAL SIGHT OR FLASH-LIGHT, ETC.) IS SUPPLIED OR USED WITH THIS FIREARM, THE FOLLOWING WARNINGS AND INSTRUCTIONS MUST BE ADHERED TO.**



**WARNING: KEEP BATTERIES AWAY FROM CHILDREN. THERE IS A CHEMICAL BURN HAZARD ASSOCIATED WITH BATTERIES.**



**WARNING: IF A NEW OR USED LITHIUM BUTTON/COIN CELL BATTERY IS SWALLOWED OR ENTERS THE BODY, IT CAN CAUSE SEVERE INTERNAL BURNS AND CAN LEAD TO DEATH IN AS LITTLE AS 2 HOURS. ALWAYS COMPLETELY SECURE THE BATTERY COMPARTMENT. IF THE BATTERY COMPARTMENT DOES NOT CLOSE SECURELY, STOP USING THE PRODUCT, REMOVE THE BATTERIES, AND KEEP IT AWAY FROM CHILDREN. IF YOU THINK BATTERIES MIGHT HAVE BEEN SWALLOWED OR PLACED INSIDE ANY PART OF THE BODY, SEEK IMMEDIATE MEDICAL ATTENTION.**

- When used correctly, batteries provide a safe and dependable source of portable power. However, misuse or abuse may result in leakage, fire, or explosion.
- Batteries can explode or leak and cause burns if installed backwards, disassembled, charged, or exposed to water, fire or high temperature.
- Always take care to install your batteries correctly observing the “+” and “-” marks on the battery and the device.
- Always replace the whole set of batteries at one time, taking care not to mix old and new batteries, or batteries of different types.
- Store unused batteries in their original packaging and away from metal objects that may short-circuit them.
- Remove discharged batteries from equipment promptly to avoid possible damage from leakage.
- Never dispose of batteries in fire. (Failure to observe this precaution may result in an explosion.)
- The batteries are supplied in a charged state and are not designed for recharging. Recharging may cause leakage, fire, or explosion.
- The batteries should be disposed of properly, including keeping them away from children.
- Dispose of used batteries immediately. Even used batteries may cause injury.



3000488

Smith & Wesson®

2100 Roosevelt Avenue • Springfield, MA 01104

[www.smith-wesson.com](http://www.smith-wesson.com)

P/N 3000488

REV:M&P BODYGUARD\_380\_080118

52