

# INSTRUCTION MANUAL FOR RUGER AMERICAN PISTOL®

## PRO MODEL



Some **RUGER AMERICAN PISTOL**® slides are milled for use with an optional reflex optic sight. Models so equipped are compatible with the following sights: Vortex® Venom®; Vortex® Viper®; Burris® FastFire™ 2; and Burris® FastFire™ 3. Reflex Optic Installation Instructions are located at the back of this manual.



– Rugged, Reliable Firearms® –



**READ THE INSTRUCTIONS AND  
WARNINGS IN THIS MANUAL CAREFULLY  
BEFORE USING THIS FIREARM**

© 2020 Sturm, Ruger & Co., Inc.

This manual may not be reproduced in whole or in part without the express written permission of Sturm, Ruger & Co., Inc.

**For Service on This Model Please Call:  
(336) 949-5200 (See p. 32)**

THIS INSTRUCTION MANUAL SHOULD ALWAYS ACCOMPANY THIS FIREARM AND BE TRANSFERRED WITH IT UPON CHANGE OF OWNERSHIP, OR WHEN THE FIREARM IS LOANED OR PRESENTED TO ANOTHER PERSON



## State-By-State Warnings

Certain states require by law that their own specified warning notices in larger-than-normal type be conspicuously included by the manufacturer, distributor or retailer with firearms sold in that state. Sturm, Ruger & Co., Inc. sells its products in compliance with applicable laws and regulations. Because our products may be sold in these states, we include the following:

### California:

#### **WARNING**

“Children are attracted to and can operate firearms that can cause severe injuries or death. Prevent child access by always keeping guns locked away and unloaded when not in use. If you keep a loaded firearm where a child obtains and improperly uses it, you may be fined or sent to prison.”

#### **ADVERTENCIA**

“A los niños los atraen las armas de fuego y las pueden hacer funcionar. Ellos pueden causarse lesiones graves y la muerte. Evite que los niños tengan acceso a las armas de fuego guardándolas siempre con llave y descargadas cuando no las esté utilizando. Si usted tiene un arma de fuego cargada en un lugar en que un niño tiene acceso a ella y la usa indebidamente, le pueden dar una multa o enviarlo a la cárcel.”

### Connecticut:

“UNLAWFUL STORAGE OF A LOADED FIREARM MAY RESULT IN IMPRISONMENT OR FINE.”

### Florida:

“IT IS UNLAWFUL, AND PUNISHABLE BY IMPRISONMENT AND FINE, FOR ANY ADULT TO STORE OR LEAVE A FIREARM IN ANY PLACE WITHIN THE REACH OR EASY ACCESS OF A MINOR UNDER 18 YEARS OF AGE OR TO KNOWINGLY SELL OR OTHERWISE TRANSFER OWNERSHIP OR POSSESSION OF A FIREARM TO A MINOR OR A PERSON OF UNSOUND MIND.”

## **Maine:**

“ENDANGERING THE WELFARE OF A CHILD IS A CRIME. IF YOU LEAVE A FIREARM AND AMMUNITION WITHIN EASY ACCESS OF A CHILD, YOU MAY BE SUBJECT TO FINE, IMPRISONMENT OR BOTH. KEEP FIREARMS AND AMMUNITION SEPARATE. KEEP FIREARMS AND AMMUNITION LOCKED UP. USE TRIGGER LOCKS.”

## **Maryland:**

“WARNING: Children can operate firearms which may cause death or serious injury. It is a crime to store or leave a loaded firearm in any location where an individual knew or should have known that an unsupervised minor would gain access to the firearm. Store your firearm responsibly!”

## **Massachusetts:**

“WARNING FROM THE MASSACHUSETTS ATTORNEY GENERAL: This handgun is not equipped with a device that fully blocks use by unauthorized users. More than 200,000 firearms like this one are stolen from their owners every year in the United States. In addition, there are more than a thousand suicides each year by younger children and teenagers who get access to firearms. Hundreds more die from accidental discharge. It is likely that many more children sustain serious wounds, or inflict such wounds accidentally on others. In order to limit the chance of such misuse, it is imperative that you keep this weapon locked in a secure place and take other steps necessary to limit the possibility of theft or accident. Failure to take reasonable preventive steps may result in innocent lives being lost, and in some circumstances may result in your liability for these deaths.”

“IT IS UNLAWFUL TO STORE OR KEEP A FIREARM, RIFLE, SHOTGUN OR MACHINE GUN IN ANY PLACE UNLESS THAT WEAPON IS EQUIPPED WITH A TAMPER-RESISTANT SAFETY DEVICE OR IS STORED OR KEPT IN A SECURELY LOCKED CONTAINER.”

**New Jersey:**

“IT IS A CRIMINAL OFFENSE TO LEAVE A LOADED FIREARM WITHIN EASY ACCESS OF A MINOR.”

**New York City:**

“THE USE OF A LOCKING DEVICE OR SAFETY LOCK IS ONLY ONE ASPECT OF RESPONSIBLE FIREARM STORAGE. FOR INCREASED SAFETY, FIREARMS SHOULD BE STORED UNLOADED AND LOCKED IN A LOCATION THAT IS BOTH SEPARATE FROM THEIR AMMUNITION AND INACCESSIBLE TO CHILDREN AND OTHER UNAUTHORIZED PERSONS.”

**North Carolina:**

“IT IS UNLAWFUL TO STORE OR LEAVE A FIREARM THAT CAN BE DISCHARGED IN A MANNER THAT A REASONABLE PERSON SHOULD KNOW IS ACCESSIBLE TO A MINOR.”

**Texas:**

“IT IS UNLAWFUL TO STORE, TRANSPORT, OR ABANDON AN UNSECURED FIREARM IN A PLACE WHERE CHILDREN ARE LIKELY TO BE AND CAN OBTAIN ACCESS TO THE FIREARM.”

**Wisconsin:**

“IF YOU LEAVE A LOADED FIREARM WITHIN THE REACH OR EASY ACCESS OF A CHILD YOU MAY BE FINED OR IMPRISONED OR BOTH IF THE CHILD IMPROPERLY DISCHARGES, POSSESSES, OR EXHIBITS THE FIREARM.”

\* \* \* \* \*

Please check with your licensed retailer or state police for additional warnings which may be required by local law or regulation. Such regulations change constantly, and local authorities are in the best position to advise you on such legal matters.

**FIREARMS SAFETY IS YOUR RESPONSIBILITY**  
**SAFETY MUST BE THE FIRST AND CONSTANT**  
**CONSIDERATION OF EVERY PERSON WHO HANDLES**  
**FIREARMS AND AMMUNITION.**

This Instruction Manual is designed to assist you in learning how to use and care for your **RUGER AMERICAN PISTOL®** properly. Please contact us if you have any questions.

Only when you are certain you fully understand the manual and can properly carry out its instructions should you practice loading, unloading, etc. with live ammunition. If you have any doubts about your ability to handle or use a particular type of gun safely, you should seek supervised instruction. Such personalized instruction often is available from local gun retailers, gun clubs or police departments. If none of these sources can help, visit [www.nra.org](http://www.nra.org) or write to the following address:

National Rifle Association  
11250 Waples Mill Road  
Fairfax, VA 22030-7400

The person possessing a gun has a full-time job. You cannot guess; you cannot forget. You must know how to use your firearm safely. **Do not use any firearm without having a complete understanding of its particular characteristics and safe use.** Remember: There is no such thing as a foolproof gun.

# TABLE OF CONTENTS

	Page
State-By-State Warnings .....	.3
Nomenclature .....	.8
Locking Device Installation Instructions .....	.9
General Information and Mechanical Characteristics .....	.11
Ammunition .....	.13
To Load and Fire .....	.14
Visual Inspection of Viewport .....	.16
Dry Firing .....	.17
To Unload .....	.17
To Reload The Pistol .....	.19
To Extract and Eject a Chambered Cartridge .....	.19
To Clear a Malfunction ("Jam") .....	.20
To Minimize Malfunctions ("Jams") .....	.21
To Disassemble .....	.21
To Reassemble .....	.25
Interchangeable Grips .....	.27
Magazine Inspection and Care .....	.28
Care and Cleaning .....	.29
Sight Adjustment .....	.31
Storage .....	.31
Service and Parts Policy .....	.32
Shipping Firearms for Repair .....	.32
Ordering Parts .....	.33
Parts List .....	.34
Exploded Views .....	.36
<b>The Basic Rules of Safe Firearms Handling .....</b>	<b>.38</b>
Warranty Information .....	.44

"Ruger" is a registered U.S. trademark of Sturm, Ruger & Co., Inc.



## WARNINGS OF GREAT IMPORTANCE ARE FOUND ON THE FOLLOWING PAGES:

Locking Devices	9	Slide Retraction	18
Alterations	11	Malfunctions	20
Pistol Function	11	Disassembly	24
Ammunition	13	Lubrication	30
Lead Exposure	13	Storage	31
Firing	15	Shipping	32
Handling	16	Parts Purchasers	33
Unloading	17		

**OTHER CAUTIONS AND WARNINGS APPEAR  
THROUGHOUT THE MANUAL.**

# NOMENCLATURE





# LOCKING DEVICE INSTALLATION INSTRUCTIONS



## WARNING – USE OF LOCKING DEVICES



**Do not store keys  
in lock.**

- Always keep your firearm pointed in a safe direction, including when you are installing or removing your locking device.
- Always verify that your firearm is completely **unloaded** (see pg. 17) before installing your locking device.
- Do **not** install locking devices in the trigger guard; always keep your fingers and locking device outside the trigger guard during device installation and removal.
- Store firearms, ammunition and keys separately and securely, away from children and careless adults; do **not** store your firearm with the keys in the locking device.
- Do not attempt to work the action of your firearm with the locking device in place; this may damage your firearm.
- While locking devices are an important aid to security measures, they are not a substitute for safe firearm handling and proper storage. Remember that any mechanical device can be bypassed with enough time, knowledge, determination and equipment.

**LOCKING DEVICES MUST BE USED  
SAFELY AND RESPONSIBLY**

It is important to use the locking device on your Ruger® firearm!

Keep the muzzle pointed in a safe direction and your fingers outside the trigger guard at all times during installation of the locking device!

### **To Install the Factory-Supplied Locking Device:**

1. Remove the magazine from your pistol.
2. Open the action completely, and verify that the firearm is completely unloaded and contains no cartridges or cartridge cases!

Use the slide stop to keep the action open during installation of the locking device.

3. Insert the cable directly to your pistol as shown in Figure 1.
4. To lock: With the key turned to the farthest clockwise position, insert the loose end of the cable into the lock. Turn the key counterclockwise and remove the key.
5. Once the lock is securely closed, pull firmly on the lock to test the connection and be sure it is locked. **Do not leave or store your firearm with the key in the lock!** Store your locked, unloaded firearm and the key in secure, separate locations, away from ammunition, children, and unauthorized adults.



Correct Installation of Cable Lock  
For Ruger American Pistol®

**FIREARMS ARE DANGEROUS WEAPONS  
READ THE INSTRUCTIONS AND WARNINGS  
IN THIS MANUAL THOROUGHLY AND  
CAREFULLY BEFORE USING.**

 <b>WARNING - ALTERATIONS</b>	
	This product was designed to function properly in its original condition. Alterations can make it unsafe. Do not alter any part or add or substitute parts not made by Sturm, Ruger & Co., Inc.
<b>DO NOT ALTER ANY GUN</b>	

## **GENERAL INFORMATION AND MECHANICAL CHARACTERISTICS**

**WARNING:** The PRO version of the **RUGER AMERICAN PISTOL**® is not equipped with an external manual safety or a magazine disconnect. This version will fire with the magazine removed and will fire by simply pulling the trigger. There is an internal striker blocker and a passive trigger safety, but there are no additional safety devices in this model. This pistol is intended for advanced firearms users. Ruger produces several pistols that contain both an external manual safety and a magazine disconnect. Each user needs to evaluate their level of training and experience when considering what firearm is most appropriate for them.

The **RUGER AMERICAN PISTOL**® is a striker-fired, magazine-fed, autoloading, recoil-operated centerfire handgun. The **RUGER AMERICAN PISTOL**® features a patent-pending, recoil-reducing barrel cam, a two-stage trigger with positive reset, and a textured modular grip system to fit every hand. The **RUGER AMERICAN PISTOL**® is fully ambidextrous and modular. It features an easy, no-trigger-pull take-down, genuine Novak® sights, stainless steel construction with Black Nitride finish, a precision machined insert, a long glass fiber nylon grip frame, and a mil-std-1913 accessory rail. Some particular features with which users should be thoroughly familiar include:

**Action:** The **RUGER AMERICAN PISTOL**® utilizes a tilting barrel design in which the barrel and slide are locked together at the moment of firing. The internal striker is cocked by the closing action of the slide. Pulling the two-stage trigger fully to the rear first disengages the internal trigger safety and

releases the internal striker block, then the last bit of trigger pull releases the striker from the sear and fires the pistol. After firing, the barrel and slide recoil to the rear a short distance while still locked together. After this initial movement, the barrel is cammed downward from its locked position, permitting full recoil of the slide and the extraction and ejection of the spent cartridge case. Upon return of the slide to its forward position by the recoil spring, the barrel is cammed back upward into its locked position in the slide.

The user of this or any autoloading pistol must always remember that when fired, it automatically reloads and recocks itself, so that simply pulling the trigger will fire the pistol again. Therefore, an autoloading pistol user must be particularly conscious to always keep the pistol pointed in a safe direction.

Slide Stop: When the last shot has been fired and the magazine is empty, the slide stop automatically holds the slide open. When there is an empty magazine in the pistol and the slide is retracted manually, the slide stop also will automatically hold the slide open. If a loaded magazine is inserted in the pistol when the slide is closed and the slide is then retracted fully, the slide stop will not automatically hold open the slide. The user can actuate the slide stop mechanism to hold the slide open at any time by retracting the slide and pushing the slide stop up.

Unless there is an empty magazine in the pistol, the slide stop can be released by drawing back slightly on the slide. When the slide is released, it will move forward under pressure from the recoil spring.

The slide stop is spring loaded downward. Therefore, when there is a loaded magazine in place and the pistol is jarred, the slide can fly forward and chamber a cartridge. For this reason and as an essential safety practice, the user should always be careful to keep fingers away from the trigger, and always keep the pistol pointed in a safe direction.

Magazines: Use of incorrect magazines in any pistol will result in malfunctions.

# AMMUNITION



The **RUGER AMERICAN PISTOL®** is compatible with all factory ammunition of the correct caliber loaded to U.S. Industry Standards, including high-velocity and hollow-point loads, loaded in brass, aluminum, or steel cartridge cases. No ammunition manufactured in accordance with NATO, U.S., SAAMI, or CIP standards is known to be beyond the design limits or known not to function in these pistols.

Be certain to use the correct cartridge for your pistol, and do not attempt to load any other cartridges into the magazine or chamber of the pistol.

 <b>WARNING – AMMUNITION</b>	
	Death, serious injury, and damage can result from the wrong ammunition, bore obstructions, powder overloads or incorrect cartridge components.  <u>Always</u> wear shooting glasses and hearing protection.
<b>IMPROPER AMMUNITION DESTROYS GUNS</b>	

## AMMUNITION (CARTRIDGES) NOTICE

WE SPECIFICALLY DISCLAIM RESPONSIBILITY FOR ANY DAMAGE OR INJURY WHATSOEVER OCCURRING IN CONNECTION WITH, OR AS A RESULT OF, THE USE IN RUGER FIREARMS OF FAULTY, OR NON-STANDARD, OR “RE-MANUFACTURED”, OR HAND-LOADED (RELOADED) AMMUNITION OR OF CARTRIDGES OTHER THAN THOSE FOR WHICH THE FIREARM WAS ORIGINALLY CHAMBERED.

 <b>WARNING - LEAD EXPOSURE</b>	
	Discharging firearms in poorly ventilated areas, cleaning firearms, or handling ammunition may result in exposure to lead and other substances known to the State of California to cause birth defects, reproductive harm, and other serious physical injury. Have adequate ventilation at all times. Wash hands thoroughly after exposure.
<b>SHOOTING OR CLEANING GUNS MAY EXPOSE YOU TO LEAD</b>	

## TO LOAD AND FIRE

Practice this important aspect of safe gun handling with an unloaded pistol until you can perform each of the steps described below with skill and confidence. **But before you do anything with the pistol, first read through this manual completely.**

1. **Be certain the muzzle is pointed in a safe direction.** (See “The Basic Rules of Safe Firearms Handling,” page 38.)
2. With an *empty* magazine in the pistol, pull the slide fully to the rear until the slide stops and lock it open. (See Figure 2.) (If there is not an empty magazine in the pistol, you will need to push upward on the slide stop.)
3. Press the magazine latch inward from either side and remove the magazine from the frame. **NOTE:** The magazine is designed to fall free of the frame of its own weight when the pistol is held in the normal firing position. You should always prevent possible damage to the magazine by not letting it drop to the ground unless rapid reloading is absolutely necessary.
4. For 10-round magazines, place 10 or fewer cartridges into the magazine from the top. For the 17-round magazine, place 17 or fewer cartridges in the magazine. For the 15-round magazine, place 15 or fewer cartridges in the magazine. The magazine has holes on the side to assist you in counting the number of cartridges in the magazine.
5. Insert the loaded magazine into the frame, taking care that the magazine is locked in place by the magazine latch. Slamming the magazine into the frame forcibly is not necessary.
6. Hold the pistol firmly in the shooting hand but **do not touch the trigger.** **Keep the pistol pointed in a safe direction.** With the other hand, grasp the rear of the slide and pull the slide to the rear as far as it will go (see Figure 2, below and “Slide Retraction Warning,” p. 18). When released, the slide will fly forward to strip the top cartridge from the magazine and chamber it.



Figure 2

Retracting the Slide

**WARNING:** The pistol is ready for instant use once the slide moves forward. Be careful!

- The striker is still blocked at all times by the internal striker block unless the trigger is pulled all the way to the rear to fire the pistol.
- The striker is fully cocked by the action of the slide moving forward. The first shot can be fired by pulling the trigger all the way to the rear, which releases the striker and then fires the pistol. Subsequent shots are fired until the magazine is empty, the striker being fully cocked by the slide as it returns to battery after each shot.

 <b>WARNING - FIRING</b>	
	<p>The slide automatically opens and shuts quickly while firing. Keep face and hands away from rear. Hot brass is ejected quickly and can burn you. Always wear shooting glasses and hearing protection.</p>
<b>SLIDE OPENS FAST - HOT BRASS EJECTED</b>	

- When the last cartridge loaded into the pistol has been fired, the magazine follower presses the slide stop upward to engage the slide, automatically holding the action open. **If the slide is shut, the shooter should always assume that there is a cartridge in the chamber!**

**Don't rely on your memory or the word of others to know if a gun or magazine is loaded. With the pistol pointed in a safe direction, visually inspect the magazine and chamber.**



## WARNING - HANDLING



Do not load the pistol until you are ready to use it, and unload it immediately when you have completed shooting. (See “Warning - Unloading” on page 17.)

If dropped or struck, the pistol may fire. Keep chamber empty unless actually firing!

For maximum safety when carrying the pistol with a loaded magazine in place, the chamber should be empty, and the slide should be closed. If placed into a holster, check it to be sure that the slide is not retracted far enough to chamber a cartridge from the magazine.

The user should never depend on any mechanical device to justify careless handling or permitting the pistol to point in an unsafe direction. The shooter should always be alert to the possibility of accidental discharge. **The only absolutely safe pistol is one in which the slide is open, the chamber is empty, and there is no magazine in the gun.**

**ANY GUN MAY FIRE IF DROPPED**

## VISUAL INSPECTION OF VIEW PORT

You should always treat every gun as though it is loaded and always keep the muzzle pointed in a safe direction. Never rely upon any safety or mechanical device to justify unsafe or careless gun handling. In order to assist you in determining the presence of a cartridge in the chamber of your **RUGER AMERICAN PISTOL®**, it is equipped with a view port. The view port is a hole in the top of the barrel and the slide at the back of the barrel (see Figure 3). This view port allows the user to look in and see the presence of a cartridge in the chamber.

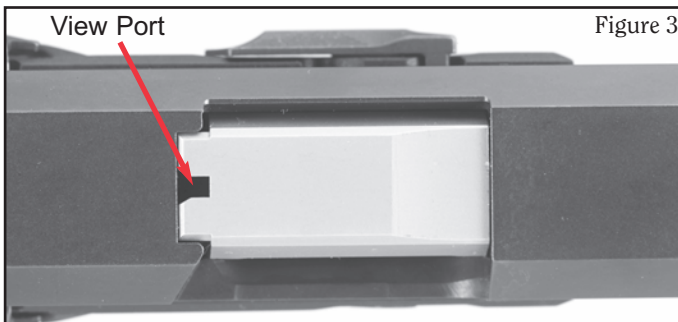

**NEVER RELY ON YOUR MEMORY, LOADED CHAMBER INDICATOR OR VIEWPORT TO KNOW IF A GUN IS LOADED. ANY MECHANICAL DEVICE CAN FAIL. ALWAYS VISUALLY CHECK THE CHAMBER BY RETRACTING THE SLIDE AND EXAMINING THE CHAMBER TO BE SURE WHETHER IT IS EMPTY OR LOADED.**



## DRY FIRING



Going through the actions of cocking, aiming and pulling the trigger on an unloaded gun is known as “dry firing.” It can be useful to learn the “feel” of your pistol. Be certain that the pistol is fully unloaded (both the chamber and magazine are empty) and that the pistol is pointing in a safe direction when you are practicing dry firing. The **RUGER AMERICAN PISTOL®** can be dry fired without damage to the striker or other components.

**NOTE:** When dry firing the **RUGER AMERICAN PISTOL®**, the trigger mechanism will not reset unless the slide is retracted at least 1/2”.

## TO UNLOAD

**WARNING:** This sequence must be followed exactly as outlined. Failure to do so can result in the chamber being unintentionally loaded with a live cartridge!

1. The muzzle of the pistol must be pointing in a safe direction at all times and fingers should be outside of the trigger guard.
2. Remove the magazine from the pistol by pushing in on the magazine latch. **REMEMBER** that even though the magazine has been removed, a live round may remain in the chamber. (See “Warning - Unloading,” below.)
3. Hold the pistol firmly and grasp the slide. Retract the slide to its rearmost position briskly to extract and eject any chambered cartridge. Always visually double-check that the chamber, breech-face, and the interior of the frame are clear of any live rounds. When the slide is fully retracted, push upward on the slide stop, then allow the slide to move forward until it comes to rest with the rear projection of the slide stop resting in the notch on the lower left side of the slide.

 <b>WARNING - UNLOADING</b>	
	Removing magazine does not unload pistol! To unload, first remove magazine, then pull slide to rear, eject chambered cartridge, and visually inspect chamber to be sure it is empty. Always point the pistol in a safe direction when loading or unloading. The pistol will fire with the magazine removed!
	<b>REMOVING MAGAZINE DOES NOT UNLOAD CHAMBER</b>

## CORRECT UNLOADING SEQUENCE

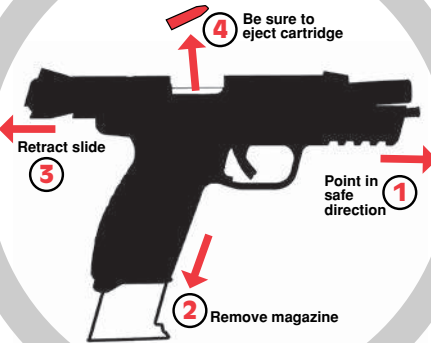

## WARNING - SLIDE RETRACTION

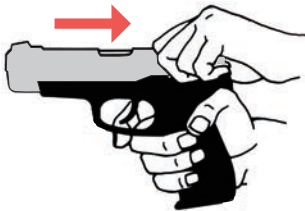

The slide should always be pulled rearward (“retracted”) by pulling the rear portion of the slide in the vicinity of the serrations. **Always keep fingers away from trigger!**

**Never put any part of your hands or body over the muzzle while retracting the slide** for loading, unloading, inspection, or clearing a malfunction.

**KEEP HANDS AWAY FROM MUZZLE AND FINGER OFF TRIGGER**

4. To close the slide, **again check to be sure the chamber and breech-face are empty.** Pull the slide to its rearmost position and release it. The slide will snap forward. Keep fingers out of the ejection port on top of slide!
5. If the magazine contains cartridges, they can be removed by sliding each cartridge forward and out of the magazine, one at a time, until the magazine is empty.
6. Push the empty (unloaded) magazine into frame until the magazine latch locks it in place.

## TO RELOAD THE PISTOL

1. Firing all cartridges in the magazine and the chamber will cause the slide to automatically lock open. **Keep the pistol pointed in a safe direction.** Press in on either magazine latch with the thumb or forefinger. The magazine will fall free of the pistol of its own weight. To avoid the possibility of damage to the magazine, do not let it fall to the ground unless rapid reloading is absolutely necessary.
2. Insert a loaded magazine. **WARNING: The slide stop is held in place by the slide pressing against the rear of the slide. Therefore, when there is a loaded magazine in place and the pistol is jarred, the slide can fly forward and chamber a cartridge. For this reason and as an essential safety practice, the pistol should always be pointed in a safe direction.**
3. Release the slide by pulling the slide fully to the rear and releasing it. A cartridge will be chambered when the slide shuts. **WARNING: The pistol is ready to fire.** When you are finished firing the pistol, unload it completely (see page 17).

## TO EXTRACT AND EJECT A CHAMBERED CARTRIDGE

When the pistol is fired, the same gas pressure that drives the bullet forward also acts through the cartridge case to push the slide to the rear. The action causes extraction and ejection of the fired cartridge case. If a cartridge fails to fire or if the shooter wishes to eject the chambered cartridge manually, follow the procedure “To Unload,” p. 17. When the slide is operated by hand, there can be a failure to extract the cartridge from the chamber, or a failure to eject the cartridge clear of the pistol. These failures usually are the result of the slide not being pulled rearward vigorously enough.

The gun user must:



1. **Always visually check the chamber and the breech-face after opening the slide to eject a chambered cartridge.** If the slide is not vigorously retracted when being operated by hand, the extracted cartridge can be “ejected” into the magazine-well of the grip frame or remain held to the breech-face by the extractor.

2. Thoroughly clean the chamber and the extractor as often as necessary.

If an empty magazine is in the pistol when the slide is being manually retracted to extract a cartridge, the cartridge may drop on top of the magazine or remain held to the breech-face by the extractor. Then when the slide goes forward, the cartridge will be chambered again! **Remember — always remove the magazine before clearing the chamber, and visually ensure that no cartridges remain anywhere in the gun.**

## TO CLEAR A MALFUNCTION (“JAM”)

1. **Be certain the muzzle is continually pointed in a safe direction.**
2. If possible, remove the magazine. It may be necessary to manually remove a stuck cartridge that has only been partially stripped from the magazine. If so, use extreme care. Lock the slide open with the slide stop before attempting to clear the jam. Drawing the slide fully to the rear may bring the stuck cartridge along. **Keep your face away from the ejection port during this operation.** When attempting to clear a jam, use only wood “tools” so that the cartridge will not be damaged or the primer ignited. A 3/16” wooden dowel with a point on one end is useful. Carefully remove the jammed cartridge from the chamber and dispose of it properly.
3. Visually check to make sure that all cartridges have been removed from the pistol. Safely dispose of any cartridges involved in a malfunction incident. Do not use damaged ammunition in any firearm.

 <b>WARNING - MALFUNCTIONS</b>	
	<p>Any autoloading pistol may occasionally malfunction. If a cartridge hangs up, jams, or binds when being chambered, do not attempt to force it into the chamber by pushing or striking the slide. Carefully remove it.</p> <p>Most failures of a cartridge to feed or to chamber properly are caused by a damaged magazine, incorrect gun handling, insufficient lubrication, or improper ammunition.</p> <p>Whatever the cause, the user of the pistol must, above all, recognize that any cartridge jam can result in a potentially very dangerous situation of a cartridge discharging before it is properly chambered. If this happens, the cartridge case may rupture and its fragments fly out of the ejection port of the pistol with sufficient force to cause serious injury. <b>Always wear shooting glasses!</b></p>
	<b>HITTING PRIMER CAN BURST CARTRIDGE</b>

## TO MINIMIZE MALFUNCTIONS (“JAMS”)

1. If it appears that the jam was caused by the type of ammunition being used, try another brand, type, or lot number. Remember — use only factory ammunition of the correct caliber.
2. If changing ammunition does not at once eliminate malfunctions, then the following steps should be taken:
  - a. Thoroughly clean the pistol, paying particular attention to the removal of accumulated grease and dirt. Use a bristle brush and solvent to remove grease and fouling from the breech-face, extractor, chamber, and feed ramp area immediately behind the chamber.
  - b. Check to be sure that the magazine spring firmly returns the magazine follower to the top of the magazine.
  - c. Check the magazine lips to be certain that they are free of nicks and burrs and that they are not deformed or cracked.
  - d. Remove excess oil and solvent from all cleaned components, load the magazine, and try the pistol again. Make sure you are following the correct loading and firing sequence as described in this manual.
  - e. If none of the above steps is effective, try a different magazine of Ruger manufacture. If a new magazine does not function correctly, return the pistol and magazines to the Ruger Customer Service Department. (See “Shipping Firearms For Repair” on page 32.)
  - f. **Alterations to the pistol or use of non-Ruger magazines and accessories may cause malfunctions. See “Warning - Alterations” on page 11.**

## TO DISASSEMBLE Be sure pistol is unloaded!

**NOTE:** An on-line video demonstrating the disassembly and reassembly of the **RUGER AMERICAN PISTOL®** can be viewed by going to [Ruger.com/TechTips](http://Ruger.com/TechTips).

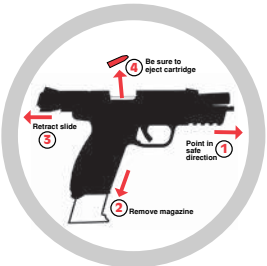
⚠ WARNING - DISASSEMBLY	
	<p>Always unload a firearm before cleaning, lubrication, disassembly or assembly.</p>
<b>UNLOAD BEFORE DISASSEMBLY</b>	

1. **Keep pistol pointed in a safe direction.** Press down on the magazine latch and remove the magazine. (See Figure 4.)

**NOTE:** Trigger should be in the forward position in order to disassemble the pistol.



2. Pull the slide to the rear and lock into the open position by pressing upward on rear of the slide stop. (See Figure 5.) **Again, be sure chamber is empty!**



3. Rotate the take down lever clockwise until it stops rotating (see Figure 6.) Once resistance is met, the lever should not be rotated any further. This action will both move the barrel locking surface out of the way of the barrel and decock the striker.

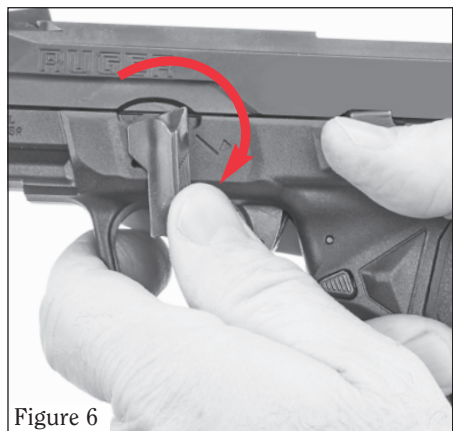

4. Pull the slide rearward to drop the slide stop (see Figure 7), then maintain control of the slide and allow it to move slowly forward.

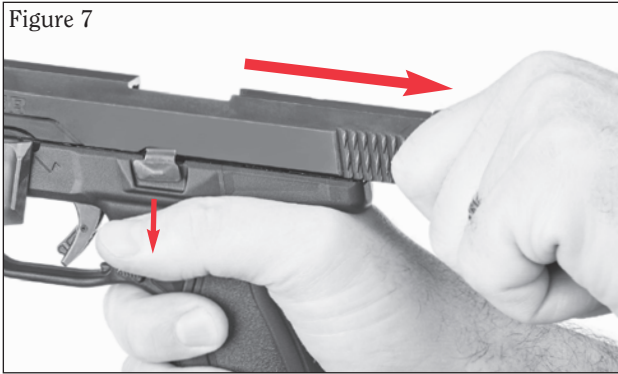

5. Remove the slide and barrel from the frame by sliding it carefully forward (see Figure 8a) and remove the entire slide assembly from the frame (see Figure 8b). **NOTE:** If you have difficulty removing the slide, verify that the take down lever is rotated fully clockwise. Be careful not to push the take down lever too far.



Figure 8a



Figure 8b

6. Hold the top of the slide and slightly depress the recoil spring to disengage the guide rod assembly from its seat against the barrel lug. (See Figure 9.) Pull the guide rod assembly down and out of the slide.

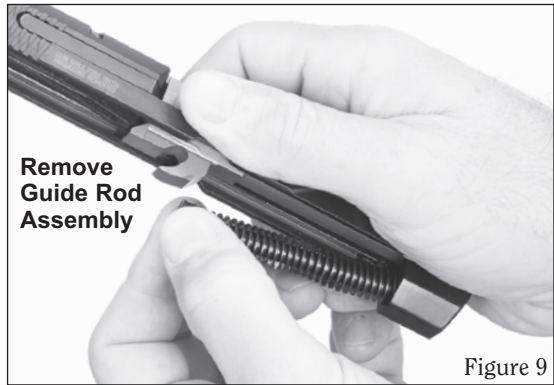

Figure 9

7. Move the barrel slightly rearward to disengage it from the slide. Pull the barrel down and out of the slide. (See Figure 10.) Your pistol is now field stripped and ready for cleaning.



Figure 10



Figure 11



## TO REASSEMBLE

1. Be certain the chamber and magazine are empty. Always keep the pistol pointed in a safe direction.

2. With the slide held upside down, replace the barrel and push it forward into its locked position. (See Figure 12.)

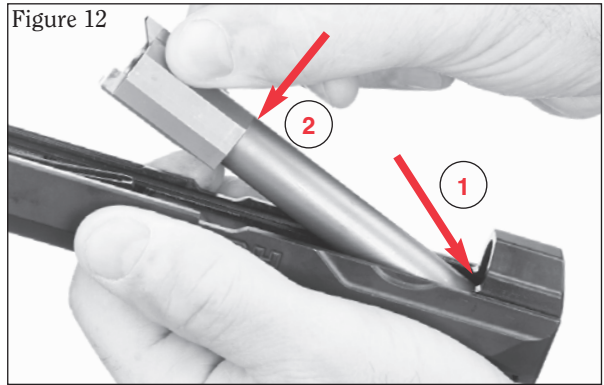

3. Place the guide rod assembly into position with the large round end of the guide rod assembly resting against the seat of the barrel lug and fully seated in the recess pocket in the barrel. (See Figure 13.)

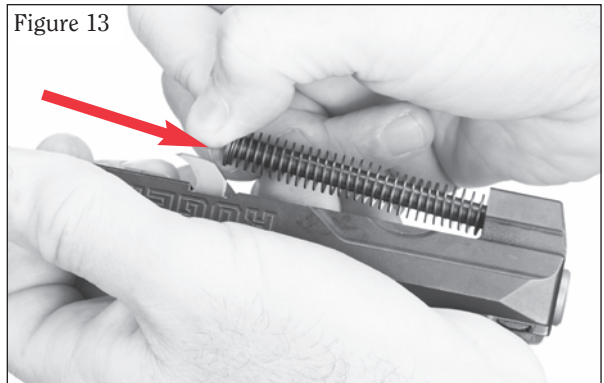

4. Replace the slide onto frame. (See Figure 14a.)



Pull the slide fully back and lock it into position by pushing upward on the slide stop. (See Figure 14b.) **NOTE:** If you have difficulty retracting the slide, verify that the take down lever is rotated fully clockwise – be careful not to force it too far.



5. Rotate the take down lever counterclockwise until it stops in the horizontal position (see Figure 15).



6. Pull the slide rearward to drop the slide stop and allow the slide to move fully forward. (See Figure 16.)

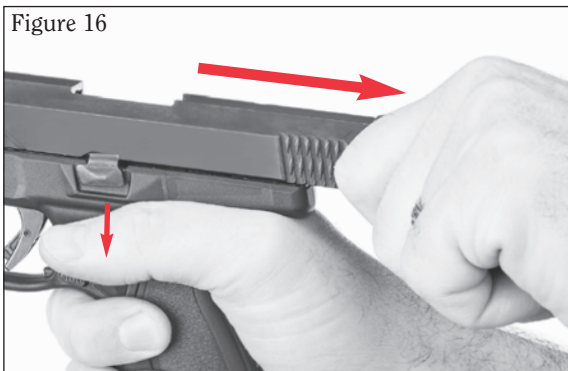

## INTERCHANGEABLE GRIPS

**Make Sure Gun Is Unloaded!**

In order to accommodate different hand sizes, the **RUGER AMERICAN PISTOL®** comes with different grip modules. To change grips, first remove the slide as shown in the “To Disassemble” instructions, pp. 21 - 24.

1. To change out the grip module, use a #10 torx wrench (included) and insert it into the slot in the back center of the grip module (see Figure 17a).
2. Rotate the grip locking cam 1/4 turn counterclockwise to unlock the grip module (see Figure 17b). Rotate the grip locking cam 1/4 turn clockwise to lock the grip module.

**DO NOT APPLY EXCESSIVE FORCE!**



Figure 17a

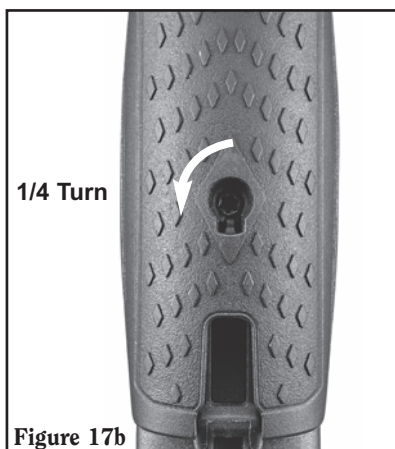

Figure 17b

3. Remove the torx wrench and hold the grip as shown in Figure 18a – squeeze slightly and pull grip 1/2 inch towards thumb as shown in Figure 18b, then pull straight out.

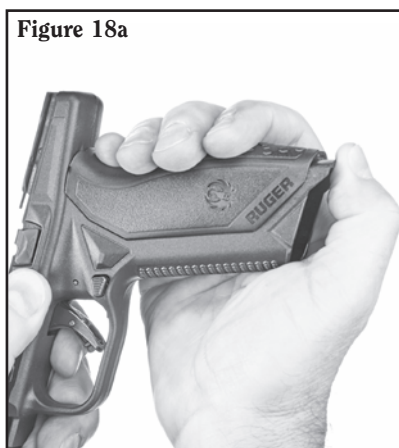

Figure 18a

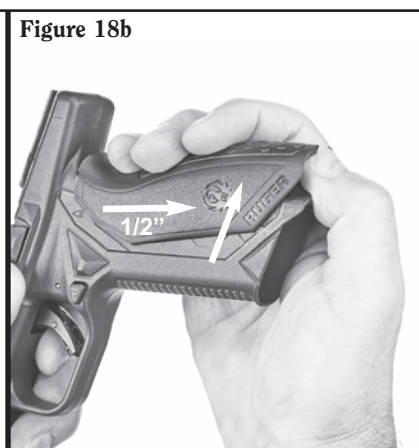
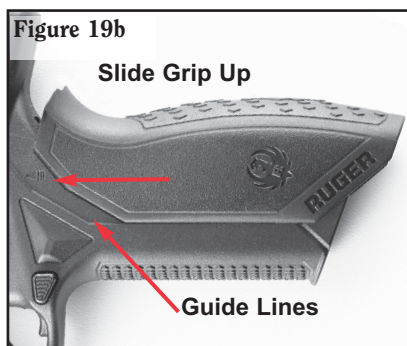
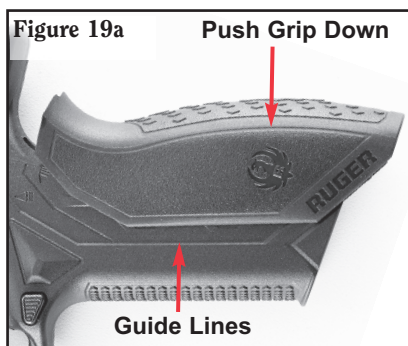

Figure 18b

4. Choose the grip module that you would like to install and push it down to the guide lines on the frame (see Figure 19a) then slide it up into position (see Figure 19b).
5. Insert the torx wrench into the slot in the back center of the grip module.
6. Rotate the locking cam clockwise until it stops turning (1/4 turn).



## MAGAZINE INSPECTION AND CARE

Check the magazine frequently. The magazine follower must move freely and have adequate tension so that each cartridge is quickly raised to the feeding position. The magazine feed lips should be clean and free of cracks, dents, or nicks, so that cartridges are held in their proper feeding position.

If the magazine becomes dirty, it should be disassembled and thoroughly cleaned. **Be sure the magazine is unloaded before disassembly.** All **RUGER AMERICAN PISTOL®** magazines are manufactured with a snap-on base. The following disassembly instructions apply:

**Snap-On Base** - Use a punch to press in on the magazine spring seat where it protrudes into the hole in the magazine floorplate. Slide the magazine floorplate toward the front of the magazine, **be careful to prevent the forcible ejection of the magazine spring seat and compressed magazine spring.** Withdraw the magazine spring seat, magazine spring, and magazine follower from the magazine body. Reassemble in the reverse order, being careful to insert the magazine spring leg in the correct orientation in the magazine spring seat (see Figure 20).

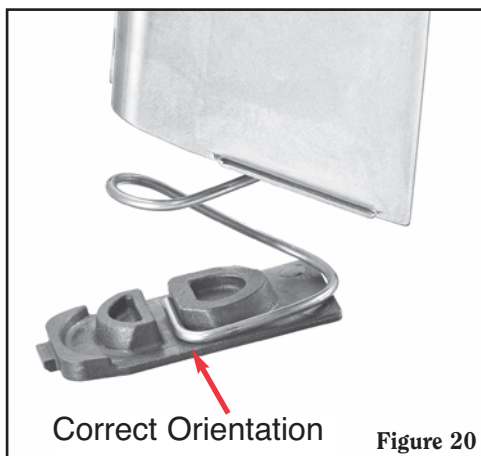

**DAMAGED, NON-STANDARD OR IMPROPERLY ASSEMBLED MAGAZINES SHOULD NOT BE USED. THEY CAN CAUSE THE PISTOL TO MALFUNCTION.**

When cleaning is necessary, use a solvent that will not rust the metal components or adversely affect the magazine body. After the magazine has been soaked to loosen foreign matter, be certain to shake it vigorously (with the loading opening away from you) to remove solvent or residue from within the magazine.

Penetrating oils and solvents inside a magazine can “kill” or weaken cartridge primers or powder which can result in failures to fire or other possibly dangerous malfunctions, such as leaving a bullet in the bore!

After cleaning, always check to be certain that the magazine follower movement and tension are correct, and that no solvent or debris remain. **Improper reassembly of the magazine can cause failure to feed, which is a potentially dangerous malfunction. If cleaning does not restore proper tension, or if you experience a problem with the magazine, don't use it. Get a new one.**

## **CARE AND CLEANING**

### **Make Sure Gun Is Unloaded!**

**BEFORE CLEANING, BE CERTAIN THE PISTOL AND ITS MAGAZINE ARE UNLOADED.** (See “Warning - Unloading,” p. 17.) **KEEP THE PISTOL POINTED IN A SAFE DIRECTION.**

At regular intervals, or whenever the pistol has been exposed to sand, dust, extreme humidity, condensation, immersion in water, or other adverse conditions, disassemble, clean, and oil it. Proper periodic maintenance is essential to the reliable functioning of any firearm.

An on-line video demonstrating the proper cleaning procedure of the **RUGER AMERICAN PISTOL®** can be viewed by going to **Ruger.com/TechTips**.

To clean the pistol, proceed as follows:

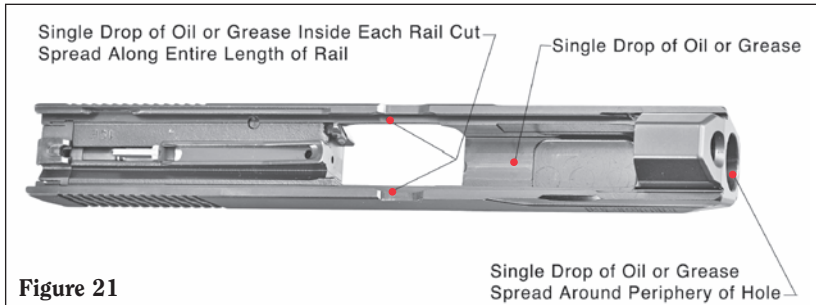

1. Disassemble (fieldstrip) the pistol to the extent described on pages 21 - 24.
2. Using a cleaning rod, run a properly sized solvent-wetted patch through the bore several times. Then attach a solvent-wetted bristle brush to a cleaning rod and run it back and forth the full length of the bore as many times as necessary to remove grease and dirt from the bore and chamber. Clean bore with dry patches and examine. Bore fouling can contribute to reduced accuracy, and grease accumulation in the chamber can interfere with proper feeding of cartridges from the magazine.
3. Using solvent on a clean patch or bristle brush, remove powder residue from all components of the pistol. Pay close attention to cleaning fouling from the claw of the extractor and from the rail cuts in the slide. After cleaning, run a dry patch through the bore, then follow with a patch that is very lightly oiled. Wipe all surfaces clean with cloth, then wipe all metal surfaces with a patch or cloth that has been very lightly oiled.

4. **NOTE:** All the components of the **RUGER AMERICAN PISTOL®** have been designed with corrosion resistance, ease of cleaning, and minimal lubrication in mind. The slide and fire control insert are stainless steel and finished with black nitride process for improved wear resistance and lubricity. The barrel and several internal components are stainless steel. Other internal components have been coated with nickel-Teflon® in order to minimize the need to clean and lubricate these components. Therefore, it is only necessary to apply a small amount of lubrication to the rail cuts in the slide, the inside top of the slide forward of the ejection port where the barrel rubs on it, and around the opening in the front of the slide where the barrel slides through (see Figure 21).



Important – excess accumulations of oil tend to attract particles of dust and dirt and may congeal in cold weather, which can interfere with the safe and reliable function of the pistol.

5. Before firing, remove all excess oil and grease from the bore by running a dry patch through the bore if necessary.

 <b>WARNING - LUBRICATION</b>	
	Firing a pistol with oil, grease, or any other material even partially obstructing the bore may result in damage to the pistol and serious injury to the shooter and those nearby. Do not spray or apply lubricants directly on ammunition. If the powder of a cartridge is affected by the lubricant, it may not be ignited, but the primer firing may push the bullet into the bore where it may be lodged. <b>Firing a subsequent bullet into the obstructed bore may damage the pistol and cause serious injury or death to the shooter and those nearby.</b> Use lubricants properly. You are responsible for the proper care and maintenance of your firearms.
	<b>IMPROPER LUBRICATION DESTROYS GUNS</b>

## SIGHT ADJUSTMENT

**RUGER AMERICAN PISTOL®** is equipped with a rear sight which is adjustable for windage only.

**To adjust for windage**, after the rear-sight lock screw has been loosened (turn counterclockwise) using a 5/64" Allen wrench, the rear sight can be drifted laterally in its dovetail on the top of the slide by tapping it with a wooden- or plastic-headed hammer or similar implement. Move the rear sight in the direction you want the shot to move on the target. After the rear sight is adjusted, tighten the rear-sight lock screw.

Some **RUGER AMERICAN PISTOLS®** have front and rear sights with white-dot inserts for rapid target acquisition and easy alignment of the sights to obtain a correct sight picture.



## STORAGE

**GUNS SHOULD NOT BE STORED LOADED!**

**USE THE LOCKING DEVICE SUPPLIED WITH THE PISTOL TO RENDER IT INOPERATIVE FOR SAFE STORAGE.**

(SEE PAGE 9)

**Do not** keep your pistol in a leather, fabric or canvas holster when it is stored. These materials attract moisture, even though the holster may appear to be perfectly dry.

 <b>WARNING – STORAGE</b>	
	<ul style="list-style-type: none"><li>• <b>Never place or store any firearm in such a manner that it may be dislodged. Firearms should always be stored securely and unloaded, away from children and careless adults.</b></li><li>• <b>Use the locking device supplied with the pistol for storage. The use of a locking device or safety lock is only one aspect of responsible firearms storage.</b></li><li>• <b>For increased safety, firearms should be stored unloaded in a location that is both separate from their ammunition and inaccessible to children and any other unauthorized person.</b></li></ul>
<b>STORE SECURELY &amp; UNLOADED</b>	



## SERVICE AND PARTS POLICY

If you have any questions with regard to the performance of your **RUGER AMERICAN PISTOL®**, please write or call (336-949-5200) our Customer Service Department in Prescott, Arizona, fully describing all circumstances and conditions involved. If you should need to return your pistol to the factory for repair, or order parts for it, please comply with the following suggestions for prompt service:



**WARNING—BEFORE SHIPPING ANY FIREARM, BE ABSOLUTELY CERTAIN THAT IT AND ITS MAGAZINE ARE UNLOADED. DO NOT SHIP CARTRIDGES WITH A FIREARM.**

### SHIPPING FIREARMS FOR REPAIR:

**RUGER AMERICAN PISTOLS®** returned to the factory for service or repair should be sent to: Sturm, Ruger & Company, Inc., Customer Service Department, 200 Ruger Road, Prescott, AZ 86301-6181. **NOTE:** You must obtain a Repair Authorization Number before returning your firearm. An authorization number can be obtained by contacting Customer Service online at [www.ruger.com](http://www.ruger.com) or calling the Customer Service Dept. at 336-949-5200. Guns should be sent prepaid. We will not accept collect shipments.



The Federal Gun Control Act, as well as the laws of most states and localities, do not prohibit an individual (who is not otherwise barred from purchasing or possessing a firearm) from shipping a firearm directly to the manufacturer for repair. However, before you ship your pistol to us, be certain that your state or locality does not have a law or regulation which will prohibit you from receiving the pistol from us after it has been repaired. If such receiving is prohibited, then please have a federally licensed firearms dealer ship the gun to us. If your pistol is sent to us by a dealer, it will be returned to that dealer after being repaired. If a handgun (pistol or revolver) is shipped by an individual who does not hold a Federal Firearms License, it must be shipped for overnight delivery via U.P.S., Federal Express or other, similar private overnight service. **NOTE:** Handguns may not be shipped via U.S. Mail. Persons who do not hold a Federal Firearms License are prohibited by Federal law from shipping a handgun by Mail. Handguns mailed in violation of the law are impounded by the Post Office.

Please do not include holsters, custom grip panels, or accessories with a firearm being shipped to the factory for service. **DO NOT SEND GUN BOXES OR LITERATURE THAT YOU CONSIDER TO BE COLLECTOR'S ITEMS – THESE ARE INVARIABLY DAMAGED OR DESTROYED IN SHIPMENT.** Always insure your shipment.

Enclose a letter which includes your name, address, telephone number, serial number, model of the firearm, and your repair authorization number. Describe in detail the trouble you have experienced with your firearm, or the work you wish to have done. Merely stating that the firearm “needs repair” is inadequate information. Please enclose copies of any previous correspondence.



All work performed is subject to a minimum labor charge and charges for shipping and handling. Custom gunsmithing service or nonstandard alterations are NOT AVAILABLE from Ruger Customer Service Departments. Please contact the Customer Service Department for pricing information.

 <b>WARNING – PARTS PURCHASERS</b>	
	<ul style="list-style-type: none"><li>• It is the purchaser's responsibility to be absolutely certain that any parts ordered from the factory are correctly fitted and installed.</li><li>• Firearms are complicated mechanisms and <b>IMPROPER FITTING OF PARTS MAY RESULT IN A DANGEROUS MALFUNCTION, DAMAGE TO THE FIREARM, AND SERIOUS INJURY TO THE SHOOTER AND OTHER PERSONS.</b></li><li>• The purchaser and installer of parts must accept full responsibility for the correct adjustment and functioning of the firearm after such installation.</li></ul>
<b>PARTS MUST FIT CORRECTLY</b>	

## ORDERING PARTS

Please contact our Prescott, Arizona Customer Service Department for parts availability and current prices. All parts orders for **RUGER AMERICAN PISTOLS®** should be sent to: Sturm, Ruger & Company, Inc., Parts Department, 200 Ruger Road, Prescott AZ 86301-6181, 336-949-5200. We cannot comply with open account or C.O.D. requests. Payment in full via credit card (Visa, MasterCard or Discover only), money order or certified bank check (no personal checks or cash, please) is required before any service will be performed. Please provide your credit card number, your name as it appears on the credit card, the expiration date, and the 3-digit security code. All parts orders are subject to a minimum charge and charges for shipping and handling. Order parts by **Part Name and specify the model and entire serial number** of the firearm for which the parts are being ordered. There is a minimum labor charge plus a shipping and handling charge if the parts are factory installed. Please contact the Customer Service Department for pricing information.

Because it is a serial numbered component, the **RUGER AMERICAN PISTOL®** fire control insert is defined as a “firearm” by Federal law and is not sold as a separate component.

\*Parts designated by an asterisk must be factory installed. These parts are installed on an exchange basis only. We will not return the replaced parts. We will not return any part that is broken, malfunctioning, badly worn or has been modified. See “Warning - Parts Purchasers,” above.



**WARNING: A gun containing broken, malfunctioning or badly worn parts should not be fired!**

# RUGER AMERICAN PISTOL® PRO MODEL

## PARTS LIST

Design, prices and specifications subject to change without notice.

**SPECIFY MODEL, CALIBER, AND SERIAL NO. WHEN ORDERING**

(See Exploded Views on Pages 35 & 36)

Key No.	Part Name
1	Rear Sight, White Dot
2	Slide
3	Spring, Rebound
4	Striker Assembly
5	Striker Cap Assembly
** 6	Fire Control Insert Assembly
7	Spring, Sear
8	Grip
9	Grip, Locking Cam
10	Magazine Assembly
11	Frame Assembly
12	Spring, Magazine Button Tension
13	Magazine Latch Thumb Piece
* 14	Pin, Magazine Latch
* 15	Spring, Magazine Latch
* 16	Magazine Latch
17	Lever, Takedown
18	Guide Rod Assembly
19	Barrel
20	Front Sight, White Dot
21	Extractor Pivot Pin
22	Extractor
23	Spring, Extractor
24	Set Screw, Rear Sight
25	Ejector
26	Blocker, Sear Connector
27	Trigger Assembly
28	Spring, Trigger Bar
29	Sear Connector
30	Spring, Sear Connector
31	Spring, Blocker
* 32	Actuator, Sear Connector
* 33	Sear

\*\* See Exploded View on Page 36

\* FACTORY INSTALLATION REQUIRED

<b>Key No.</b>	<b>Part Name</b>
* 34	Spring, Actuator
* 35	Actuator, Takedown
36	Bar Trigger
† 37	Fire Control Insert
* 38	Pin, Sear/Safety Pivot
39	Pin, Blocker Pivot
40	Bar, Takedown
41	Pin, Sear Connector Pivot
42	Pin, Ejector Retaining
43	Pin, Cam
44	Spring, Slide Stop
45	Slide Stop

\* FACTORY INSTALLATION REQUIRED

† Because the Fire Control Insert is a serial-numbered component, it is defined as a “firearm” by Federal law and is not sold as a separate component.

# RUGER AMERICAN PISTOL® PRO MODEL EXPLODED VIEW

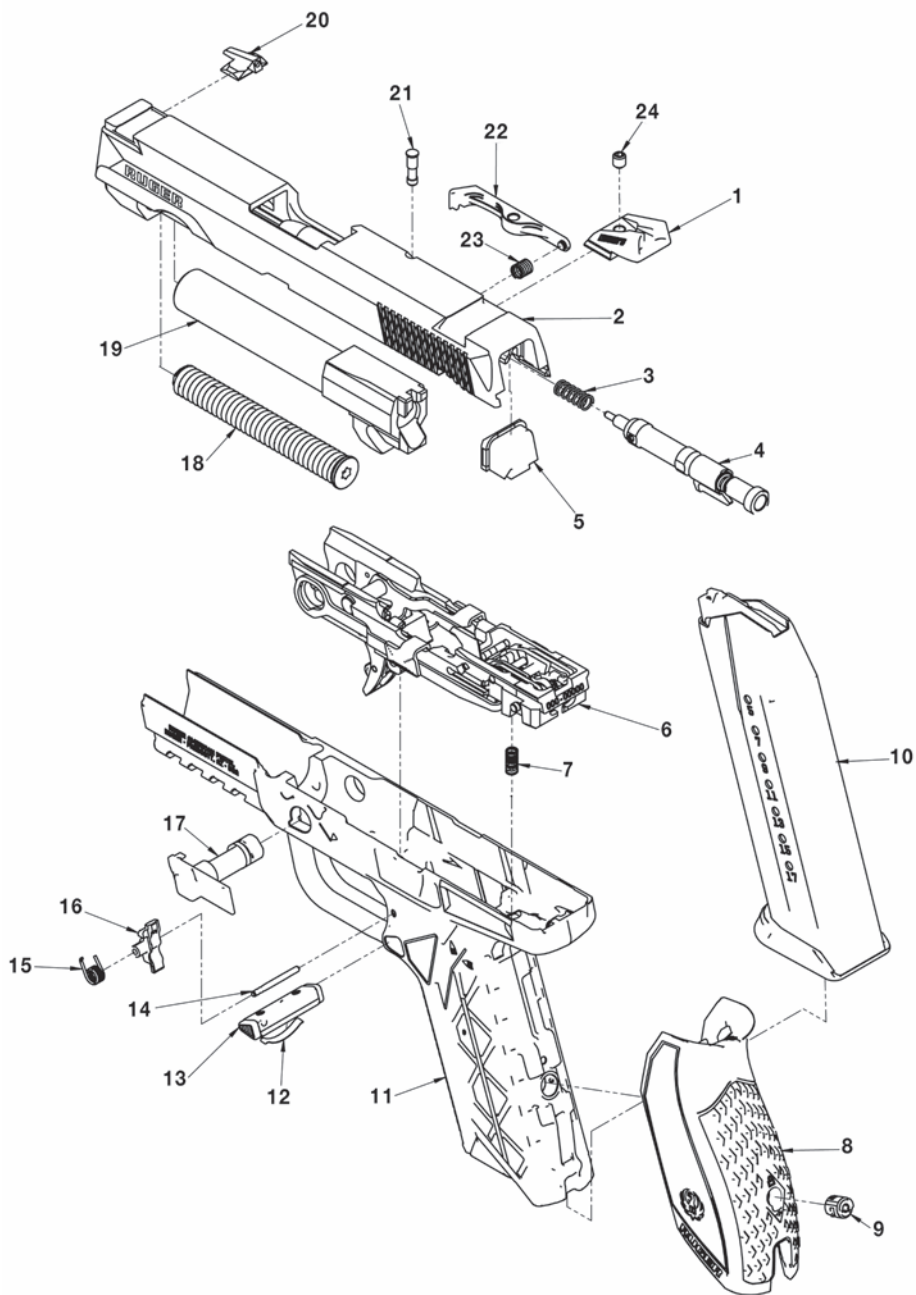

**RUGER AMERICAN PISTOL®**  
**PRO MODEL**  
FIRE CONTROL INSERT ASSEMBLY  
EXPLODED VIEW

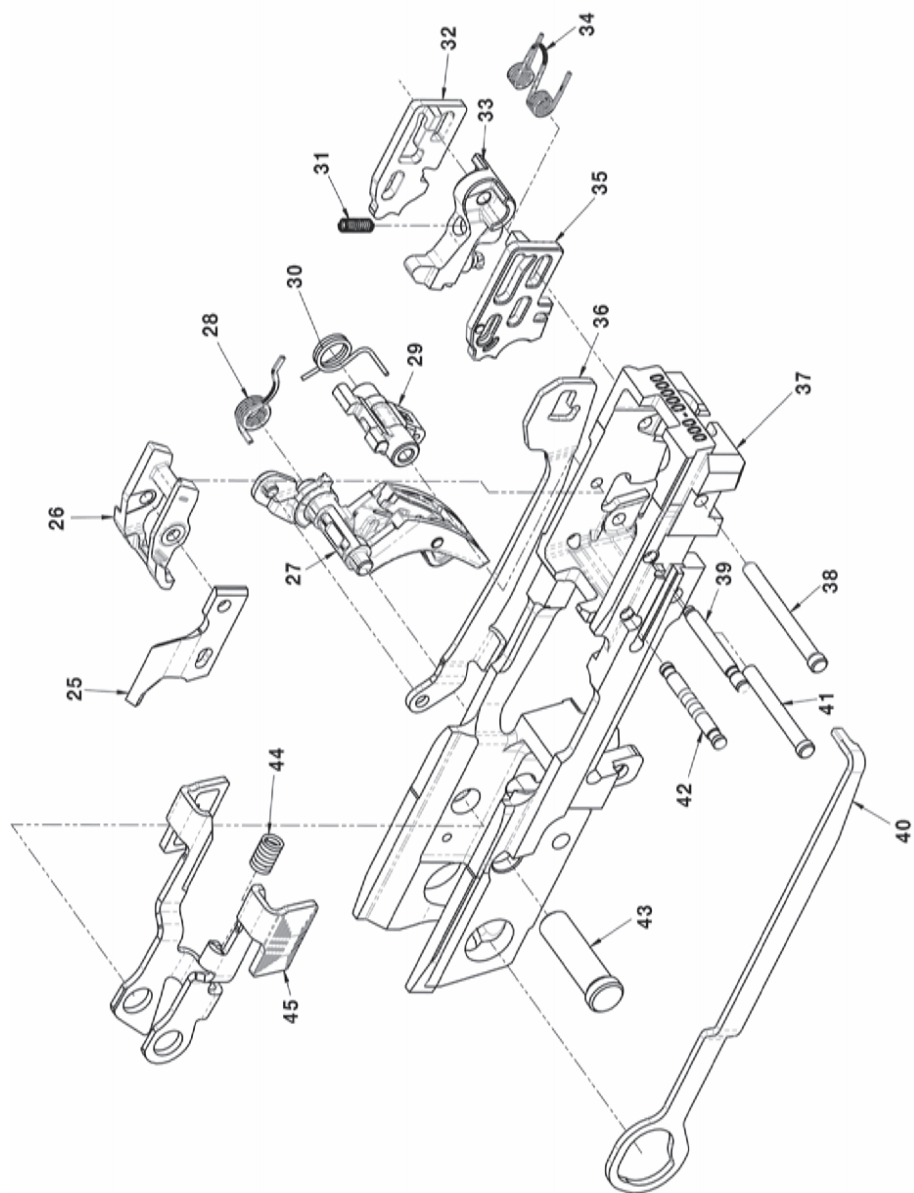

## THE BASIC RULES OF SAFE FIREARMS HANDLING

We believe that Americans have a right to purchase and use firearms for lawful purposes. The private ownership of firearms in America is traditional, but that ownership imposes the responsibility on the gun owner to use his firearms in a way which will ensure his own safety and that of others. When firearms are used in a safe and responsible manner, they are a great source of pleasure and satisfaction, and represent a fundamental part of our personal liberty.

Firearms do not cause accidents! Firearms accidents are almost always found to have been the result of carelessness or ignorance on the part of the shooter of the basic rules of safe gun handling.

The following rules must be observed by gun users at all times. Safe gun handling is not just desirable, it is absolutely essential to your safety, the safety of others, and the continuation of gun ownership and sport shooting as we know it today.

### 1. LEARN THE MECHANICAL AND HANDLING CHARACTERISTICS OF THE FIREARM YOU ARE USING.



Not all firearms are the same. The method of carrying and handling firearms varies in accordance with the mechanical provisions for avoiding accidental discharge and the various proper procedures for loading and unloading. No person should handle any firearm without first having thoroughly familiarized himself with the particular type of firearms he is using, and with safe gun handling in general.

### 2. ALWAYS KEEP THE MUZZLE POINTED IN A SAFE DIRECTION.



Be sure of the bullet stop behind your target, even when dry-firing. Never let the muzzle of a firearm point at any part of your body or at another person. This is particularly important when loading or unloading a firearm. In the event of an accidental discharge, no injury can occur as long as the muzzle is pointing in safe direction. A safe direction means a direction that will not permit a discharged bullet to strike a person, or to strike an object from which the bullet may ricochet.

A safe direction must take into account the fact that a bullet may penetrate a wall, ceiling, floor, window, etc., and strike a person or damage property. Make it a habit to know exactly where the muzzle of your gun is pointing whenever you handle it, and be sure that you are always in control of the direction in which the muzzle is pointing, even if you fall or stumble. Keep your finger off the trigger until you are ready to shoot.

### 3. FIREARMS SHOULD BE UNLOADED WHEN NOT IN USE.

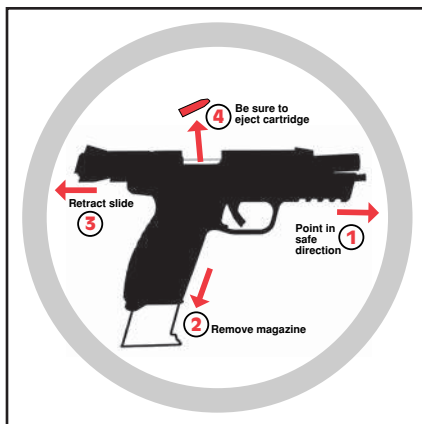

Firearms should be loaded only when you are in the field or on the target range or shooting area, ready to shoot. Firearms and ammunition should be securely locked in safes, racks or cabinets, or by using the locking device supplied with the firearm when not in use. Ammunition should be safely stored separate from firearms. Store your firearms out of sight of visitors and children. It is the gun owner's responsibility to be certain that children and persons unfamiliar with firearms cannot gain access to firearms, ammunition, or components.

### 4. BE SURE THE BARREL IS CLEAR OF OBSTRUCTIONS BEFORE SHOOTING.

Even a bit of mud, snow or excess lubricating oil or grease in the bore may cause the barrel to bulge, or even burst on firing, and can cause injury to the shooter and bystanders. Be sure that you are using ammunition of the proper caliber and loading for the gun you are using. If the report or recoil on firing seems weak, or doesn't seem quite right, **CEASE FIRING IMMEDIATELY**, unload your firearm, and check to be sure that no obstruction has become lodged in the barrel. Never try to shoot an obstruction out!





## 5. BE SURE OF YOUR TARGET BEFORE YOU SHOOT.

Don't shoot unless you know exactly where your bullet is going to strike. Be sure of the bullet stop behind your target, even when dry-firing with an unloaded gun. If you are in the field hunting, do not fire at a movement or noise. Take the time to be absolutely certain of your target before you pull the trigger.

## 6. WEAR SHOOTING GLASSES AND HEARING PROTECTION WHEN YOU SHOOT.

All shooters should wear protective shooting glasses and adequate hearing protection when shooting. Exposure to shooting noise can damage hearing, and wearing adequate eye protection when shooting is essential.



## 7. NEVER CLIMB A TREE OR FENCE WITH A LOADED FIREARM.

Put the firearm down carefully before climbing a fence, and unload it before climbing or descending a tree or jumping over a ditch or other obstruction. Never pull or push a loaded firearm toward yourself or another person. When in doubt, or whenever you are about to do anything awkward, unload your gun!



## 8. DON'T SHOOT AT A HARD SURFACE OR AT WATER.

Bullets can glance off many surfaces like rocks or the surface of water and travel in unpredictable directions with considerable velocity.



## 9. NEVER TRANSPORT A LOADED FIREARM.

Firearms should always be unloaded before being moved or placed in a vehicle. A suitable carrying case or scabbard should be used to carry an unloaded firearm to and from the shooting area.

## 10. AVOID ALCOHOLIC BEVERAGES WHEN SHOOTING.

Don't drink until the day's shooting is over. Handling firearms while under the influence of alcohol in any form, or medications that could affect your judgement or coordination, constitutes a criminal disregard for the safety of others.



## A BRIEF ACCOUNT OF AN EXTRAORDINARY ACHIEVEMENT: RUGER® FIREARMS

Sturm, Ruger & Company, Inc., had its beginning in a small machine shop occupying a rented frame building in Southport, Connecticut. In January, 1949, with an initial investment of only \$50,000 and an idea, William B. Ruger and Alexander M. Sturm started production of a .22 caliber autoloading pistol—a design which was so successful that it became the cornerstone upon which one of the most comprehensive lines of sporting firearms ever made in America was established. After Alex Sturm's death in 1951, William B. Ruger continued to direct the Company until his death in 2002. William B. Ruger, Jr. continued to provide guidance, which helped make this Company a sound and successful enterprise, until his retirement in 2006. The Company has continued to prosper, under new management and guidance from our Board, with new products and fresh perspectives.

Ruger, in this relatively short time, has established itself as a leading small arms design organization, developing a unique and broad line of fine quality sporting, military and police firearms to become one of the world's most famous producers of revolvers, pistols, rifles and shotguns. Since 1949, Ruger craftsmen have built many millions of firearms.

During its five decades of growth and progress under the leadership of William B. Ruger, the Company developed a business philosophy and implemented policies which represent a constructive influence in the life of modern America. From the beginning, Ruger played a positive role in conservation efforts and has supported the interests of shooters through such groups as the National Rifle Association, National Shooting Sports Foundation, and many regional sportsmen's organizations.

The Company has always endeavored to market its firearms for constructive and recreational purposes, to emphasize the traditional and responsible aspects of shooting, to render meaningful public services, and to encourage shooters in constructive, responsible, and safe participation in the shooting sports. Its motto, "Arms Makers For Responsible Citizens®," exemplifies this Company philosophy.

Today, Ruger® is particularly mindful of those elements which have contributed to the creation of its success, and extends heartfelt thanks to its many loyal employees and customers.

The firearms catalog, and instruction manuals for all Ruger® firearms, can be downloaded from our website at:

**[www.ruger.com](http://www.ruger.com)**

## NOTES

## WHY NO WARRANTY CARD HAS BEEN PACKED WITH THIS NEW RUGER® FIREARM

The Magnuson-Moss Act (Public Law 93-637) does not require any seller or manufacturer of a consumer product to give a written warranty. It does provide that if a written warranty is given, it must be designated as "limited" or as "full" and sets minimum standards for a "full" warranty. Sturm, Ruger & Company, Inc. has elected not to provide any written warranty, either "limited" or "full", rather than to attempt to comply with the provisions of the Magnuson-Moss Act and the regulations issued thereunder. There are certain implied warranties under state law with respect to sales of consumer goods. As the extent and interpretation of these implied warranties varies from state to state, you should refer to your state statutes. Sturm, Ruger & Company wishes to assure its customers of its continued interest in providing service to owners of Ruger® firearms.



**STURM, RUGER & COMPANY, INC.**  
200 Ruger Road  
Prescott, Arizona 86301 U.S.A.  
[www.ruger.com](http://www.ruger.com)

**Arms Makers For Responsible Citizens®**

**A COPY OF THE INSTRUCTION MANUAL FOR ANY RUGER®  
FIREARM IS AVAILABLE FROM THE FACTORY FREE ON REQUEST, OR IT MAY BE  
DOWNLOADED FROM OUR WEBSITE AT [WWW.RUGER.COM](http://WWW.RUGER.COM).**

**THESE INSTRUCTION MANUALS CONTAIN IMPORTANT  
WARNINGS WHICH MUST BE UNDERSTOOD  
BEFORE USING THESE FIREARMS.**

**The Following are Sturm, Ruger & Co., Inc. Trademarks:** "BX-Trigger," "Bisley," Eagle Hard "R" logo holding gun, "Elite 452," "Gold Label," "I'm a Ruger American," "LC6," "LCR-357," "LC380CA," "Mark II," "Mark III," "Match Champion," "Model 96," "P345," "P345D," "P345PR," "P85," "P90," "P91," "P93," "P94," "P95," "P97," "R.I.O.S.," "Ruger Marksman Adjustable," "Ruger 77/50," "Ruger 10/17," "Ruger Titanium," "77/357," "Single-Seven," "SR45," "SR-556C," "SR-556VT," "SR-762," "10/22-FS," "This is Ruger. This is America.," "Tri-Flex," "22 Charger," "22/45," and "22/45 RP."

**The Following are Registered U.S. Trademarks Belonging to Sturm, Ruger & Co., Inc.:** Sturm,Ruger Logo," "AC-556," "AR-556," "Arms Makers For Responsible Citizens," "All-Weather," "Bearcat," "Blackhawk," "BX-15," "BX-25," Eagle 'R' - soft 'R' & hard 'R,' Eagle 'SR,' "Everything you need and nothing you don't.," "GP100," "Hawkeye," "It's Mine and It's American," "It's Mine. And It's American," "LC380," "LC9," "LC9s," "LC9s Pro," "LCP," "LCR," "LCRx," "M77," "Mini Thirty," "Mini-14," "9E," "Old Army," "Power Bedding," "Redhawk," "RUGER," "Ruger American Pistol," "Ruger American Rifle," "Ruger American Rimfire," "Ruger Hunting" - phrase & logo design, "Ruger Inside & Out" - phrase & logo design, "Ruger Precision Rifle," "Ruger 77/17," "Ruger 77/22," "Ruger 77/44," "Ruger SP101," "Ruger 10/22 Takedown" phrase & logo design, "Ruger 22/45 Lite," "Ruger Vaquero," "Rugged, Reliable Firearms," "Security-Six," "Service-Six," "Silent-SR," "Single-Nine," "Single-Six," "Single-Ten," "Speed-Six," the "SR" Design, "SR9," "SR9c," "SR40," "SR40c," "SR-22," "SR22," "SR-556," "SR-556E," "SR-556 Takedown," "SR1911," "Super Redhawk Alaskan," "Target Grey," and "10/22."

# RUGER AMERICAN® PISTOL

## REFLEX OPTIC INSTALLATION INSTRUCTIONS

### TOOLS REQUIRED:

Torque Wrench (in-lb) with 5/64" Bit (Optional)

5/64" Hex Wrench

### INSTALLATION INSTRUCTIONS:

#### Make Sure Firearm Is Unloaded!

Some **RUGER AMERICAN PISTOL**® slides are milled for use with an optional reflex optic sight. Models so equipped are compatible with the following sights: Vortex® Venom®; Vortex® Viper®; Burris® FastFire™ 2; and Burris® FastFire™ 3.

1. With the pistol pointing in a safe direction, remove the magazine, retract the slide and make certain there is not a cartridge in the chamber. Keeping the pistol pointed in a safe direction, perform the steps below:
2. Field strip the pistol in accordance with the instruction manual.
3. Using a 5/64" hex wrench, remove the two screws retaining the optic mount cover plate (see Figure 1). Be sure to keep these screws and the optic mount cover plate for future reinstallation if desired.

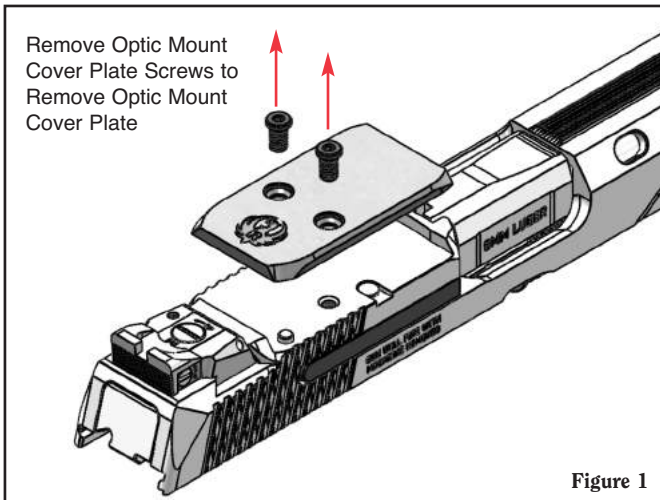

4. Following the optic manufacturer's installation instructions, mount the optic on the rear of the pistol slide using the optic mounting screws and torque specifications provided by the optic manufacturer. **NOTE:** Before tightening the optic mounting screws to the slide, ensure that the optic is correctly positioned over the two small studs on the slide's optic mounting surface. With the optic correctly positioned on the slide, the bottom of the optic should be flush with the top of the slide's optic mounting surface.
5. Reassemble the pistol as detailed in the instruction manual.

## **MAINTENANCE:**

Check the screw tightness on a regular basis and re-tighten to the proper specifications as needed. When not using an optic, you may reinstall the optic mount cover plate. To reinstall the optic mount cover plate, use a 5/64" hex wrench and tighten the optic mount cover plate screws to 20-26 in-lbs. It may be necessary to apply a minimal amount of medium-strength (typically blue), removable threadlocking compound directly to the screw threads.