



 **TAURUS**[™]

S|P|E|C|T|R|U|M[™]

INSTRUCTION MANUAL

GENERAL SAFETY, OPERATING INSTRUCTIONS AND LIMITED WARRANTY

READ CAREFULLY BEFORE USING YOUR FIREARM

Important: Keep this manual with your firearm.

The information contained in this manual is useful, both for beginners and experienced shooters. In addition to important information about the function, cleaning, and care of the firearm, the manual contains instructions that will be very helpful in shooting. **The most important rule of safe firearm handling is always keep the muzzle pointed in a safe direction.**



S|P|E|C|T|R|U|M™

TaurusUSA.com



/TaurusUSA



@taurususa



/TaurusUSA

- 380 AUTO
- Slide Finish: Stainless Steel or Black Melonite™
- Striker Fire (Non-Energized Striker System)
- DAO (Double Action Only)
- Striker Block Safety
- Soft-Touch Overmold (Variety of Colors)
- Ergonomic Design
- Weight 10 oz. Unloaded
- Two Magazines
- Capacity 6 Rounds / 7 Rounds with Extended Magazine

CONTENTS

Firearms Safety	6
Get To Know Your Pistol.....	12
Ammunition	16
Operating Instructions.....	20
Disassembly	22
Assembly	27
Care and Maintenance.....	29
Exploded View.....	30
Taurus® Service	32
Limited Warranty	34





WARNING

The safety warnings in this booklet are important. By understanding the dangers inherent in the use of any firearm, and by taking the precautions described herein, you can safely enjoy your Taurus® firearm. Failure to follow any of these warnings may result in serious injury to you or others, as well as severe damage to the firearm or other property.

Intentionally left blank

NOTES

SIGNAL WORDS AS DEFINED BY ANSI Z535.6 AND Z535.4 STANDARDS.

 DANGER	DANGER indicates a hazardous situation which, if not avoided, will result in death or serious injury.
 WARNING	WARNING indicates a hazardous situation which, if not avoided, could result in death or serious injury.
 CAUTION	CAUTION indicates a hazardous situation which, if not avoided, could result in minor or moderate injury.
NOTICE	NOTICE is used to address practices not related to physical injury.

FIREARMS SAFETY



WARNING

When a firearm discharges, the bullet or shot can strike a person, resulting in death or serious bodily injury.

The three basic keys to safe handling of firearms:

- 1. KEEP YOUR FINGER OFF THE TRIGGER UNTIL YOU ARE READY TO FIRE.** If you maintain good trigger discipline, it is extremely unlikely the firearm will fire.
- 2. KEEP THE MUZZLE POINTED IN A SAFE DIRECTION.** Even if the firearm discharges, if the muzzle is pointed in a safe direction, no one will be injured.
- 3. NEVER TRUST ANY SAFETY MECHANISM.** If you adopt the attitude that you will not trust any safety mechanism, you will be vigilant about keeping your finger off the trigger and keeping the muzzle pointed in a safe direction.



WARNING - KNOW YOUR TARGET

Never fire at targets at close range. Ricochets can and do cause death or serious bodily injury. What constitutes “close range” depends on many factors including target material, bullet caliber and angle of impact.

KNOW WHAT IS BEHIND YOUR TARGET. Unless you are shooting into a bullet trap designed to capture the type of ammunition you are firing, projectiles may pass through the target and strike anyone or anything beyond. Bullets can travel miles.

ALWAYS WEAR HEARING PROTECTION. Firearms are loud. The sound they generate is greater indoors. Repeated exposure to loud noises can cause deafness. Hearing protection is rated by decibel reduction. Look for “dB” reduction of 30 or more when purchasing ear protection. Modern ear protection can allow normal hearing until the sound from the discharge reaches the ear. By layering hearing protection, for example, wearing 30db rated foam plugs with 20db rated ear muffs, significant protection can be achieved.

ALWAYS WEAR EYE PROTECTION. In normal operation, firearms emit hot high-velocity gases, particles and metal. These materials flying into your eye can cause blindness. Protect your vision with proper eye protection. Any eye protection may be better than none, but look for ANSI Z87.1-2003 certified eyewear for the best protection.

NEVER HANDLE FIREARMS WHILE UNDER THE INFLUENCE OF DRUGS OR ALCOHOL. Firearms are dangerous. Handling firearms while impaired by drugs or alcohol is foolhardy and may result in serious injury or death. This warning includes prescription drugs that contain a warning about using machinery or driving while taking the medication.

MODIFIED FIREARMS ARE DANGEROUS, AND USE CAN RESULT IN SERIOUS INJURY OR DEATH. “Trigger jobs,” polishing original components or installing aftermarket parts can cause a firearm to function in ways different than intended. Some such work may also be illegal.

DAMAGED FIREARMS ARE DANGEROUS, AND USE CAN RESULT IN SERIOUS INJURY OR DEATH. Repairs should always be made by a qualified gunsmith or by a factory-authorized repair site. Work done by those unfamiliar with the design can cause a firearm to function in ways different than intended.

NEVER ATTEMPT TO DISASSEMBLE OR CLEAN A LOADED FIREARM. DOING SO CAN RESULT IN SERIOUS BODILY INJURY OR DEATH. How often have we heard “But it went off while I was cleaning it!” or, “I did not know it was loaded!” or, “It was jammed, and I tried to take it apart!”?

IF A FIREARM GOES OFF, THERE WAS A ROUND OF AMMUNITION IN THE CHAMBER. Period. “Clear” (or empty) the firearm of all ammunition before disassembling or cleaning.

As owner of your new Taurus® firearm, you are responsible for (1) keeping your finger off the trigger, (2) pointing the muzzle in a safe direction, (3) removing the magazine, (4) pulling the slide to the rear and locking it back and (5) looking and feeling in the magazine well and chamber to confirm the pistol is empty. An empty firearm cannot fire.

FIREARMS SAFETY SYSTEMS

Firearms safety is supported by a system. With your pistol, the system is made up of the following:

1. You! Your involvement in safety cannot be overemphasized. No safety component can keep your finger off the trigger and the muzzle pointed in a safe direction. Also, you are the key to never trusting any of the mechanical parts of the safety system.

2. Striker Block. The striker block interferes with the forward travel of the striker until the trigger is pulled. Like a trigger safety, pressing the trigger moves this safety component from its “safe” (blocking) position to its “fire” (free) position.

3. Trigger Guard. This is a physical obstruction that helps prevent unintended pressing of the trigger or trigger safety. Do not modify the trigger guard.

4. This Manual. Taurus intends for you to use this manual to learn about your pistol and to help you use your pistol safely. If you use the manual, you will go a long way toward being a knowledgeable and safe firearms owner.

5. On Line Resources. TaurusUSA.com hosts a library of videos concerning safety and related issues. This library is being added to and revised. Please visit the site and take advantage of what is available there as part of your education regarding using your Taurus pistol in a safe fashion.

PISTOL AND REVOLVER SIZE AND SAFETY

The selection of a revolver versus a pistol as well as the size, caliber and magazine capacity of a handgun are personal choices. There are many choices to be made, and there are advantages and disadvantages for each. When selecting a pistol, size has safety implications because of the way pistols are loaded.

Generally speaking, smaller handguns may require more attention to be handled safely than medium or full-size handguns. This is because their small size makes it easier to point the muzzle at your hand or to “sweep” (swing the muzzle across your body) yourself or others in ordinary handling.

When chambering a round, we recommend pulling the slide to the rear by gripping the rear of the slide, with the muzzle pointed straight and away from your body and in a safe direction.

SAFE CARRY CONDITION

“Safe Carry Condition” is the most ready-to-fire condition that the user feels is reasonable under the circumstances. Generally, we believe that Taurus® pistols should be carried with a full magazine and an empty chamber. Under most circumstances, this provides the best balance of readiness and safety. On the plus side, if the chamber is empty, unintended discharges are minimized. However, the slide must be manipulated to load a round in the chamber. In emergency circumstances, this can be difficult to do safely and correctly.

If the user believes that he or she is faced with an increased threat, chambering a round is appropriate. For safety reasons, this should be done beforehand with the muzzle pointed in a safe direction, and your finger off the trigger. How do you know you may be going into a more dangerous situation? That depends. If, for example, you carry cash to deposit after a business closing, this may well qualify. If a domestic partner is actively threatening you, this may qualify as well.

“Safe Carry Condition” is a judgment call and must be made by the user. Some users routinely face greater threats than others. Users must be aware of their situation and circumstances. Errors in judgment can have dire and tragic outcomes if firearms are present.

CARRYING FIREARMS

Carrying a firearm can be dangerous and puts great responsibility on the person in possession of the firearm. Carrying or handling a firearm makes it more difficult to maintain control over the muzzle and makes it more likely that the firearm may be dropped or bumped, resulting in the firearm discharging. There are advantages and disadvantages to various methods of carrying any firearm. Educate yourself and choose which carry method is best for you and those around you.

In almost all circumstances, it is safest to carry a handgun in a holster designed for that specific handgun. Carrying a handgun in a pocket without a specific designed In-Pocket Holster or a trigger shield or in a waist band without a belt clip is always a last choice. Carrying any handgun in a holster that fits the firearm and style of carry should prevent it from accidentally falling and you from losing control of the muzzle.

Except in rare high-threat circumstances, carry your pistol with a full magazine and an empty chamber. If the chamber is empty, the pistol cannot fire.

WARNING - CARRYING

Do not carry your firearm in any way that might let it fall or be bumped. If a firearm falls or is bumped, it may fire.

WARNING - CARRYING

Always review and follow the holster or luggage manufacturer's instructions or the firearm may fall or be bumped and fire.

FIREARMS STORAGE AND GUN LOCKS

How you secure your firearms is a personal choice based on the unique circumstances in your home, business or vehicle and the laws of the state where your firearm is located. Any choice you make about securing your firearms will present advantages and disadvantages. It is up to you to weigh those advantages and disadvantages and choose which security method is best for you and those around you.

WARNING - LOCKING

Never lock a firearm with a round of ammunition in the chamber. Unlocking a loaded firearm makes it more difficult to maintain trigger discipline and to keep the muzzle pointed in a safe direction.

WARNING

Securing your firearm may inhibit access in a defensive situation and may result in injury or death.

WARNING

Failure to secure a firearm may result in injury or death. Properly securing a firearm means storing your firearm unloaded, decocked and securely locked, with all ammunition in a separate location.

GET TO KNOW YOUR PISTOL



SPECIFICATIONS

Model	Taurus Spectrum™
Caliber	380 Auto
Action	Double Action Only (DAO)
Capacity	6 Rounds - Standard Magazine 7 Rounds - Extended Magazine
Barrel Length	2.8"
Overall Length	5.40"
Overall Height	3.82"
Overall Width	0.89"
Weight	10 oz.
Sights (Front)	Integrated Low Profile
Sights (Rear)	Integrated Low Profile
Materials	Frame: Aerospace Grade Aluminum Barrel: Alloy Steel or Stainless
Safety Device	Striker Block
Finish	Various Colors
Grip	Soft-Touch Overmold
Firing System	Striker
Trigger Pull	7-9 lbs.
Slide Material	Stainless Steel
Slide Finish	Black Melonite™ or Matte Stainless
Mag Release	Reversible

LOCKING DEVICE INSTALLATION INSTRUCTIONS



WARNING - LOCKING DEVICES

- Always keep your firearm pointed in a safe direction, including when you are installing or removing your locking device.
- Always verify that your firearm is completely unloaded (see page 23) before installing your locking device.
- Do not install locking devices in the trigger guard; always keep your fingers and locking device outside the trigger guard during device installation and removal.
- Store firearms, ammunition and keys separately and securely, away from children and careless adults; do not store your firearm with the keys in the locking device.
- Do not attempt to work the action of your firearm with the locking device in place; this may damage your firearm.
- While locking devices are an important aid to security measures, they are not a substitute for safe firearm handling and proper storage. Remember that any mechanical device can be bypassed with enough time, knowledge, determination and equipment.

LOCKING DEVICES MUST BE USED SAFELY AND RESPONSIBLY

It is important to use the locking device on your Taurus® firearm!

Keep the muzzle pointed in a safe direction and your fingers outside the trigger guard at all times during installation of the locking device!

To Install the Factory-Supplied Locking Device:

1. Remove the magazine from your pistol.
2. Open the action completely, and verify that the firearm is completely unloaded and contains no cartridges or cartridge cases! Use the slide stop to keep the action open during installation of the locking device.
3. Insert the cable directly in your pistol as shown in Figure 1.
4. To lock: With the key turned to the farthest clockwise position, insert the loose end of the cable into the lock. Turn the key counterclockwise and remove the key.
5. Once the lock is securely closed, pull firmly on the lock to test the connection and be sure it is locked. Do not leave or store your firearm with the key in the lock! Store your locked, unloaded firearm and the key in secure, separate locations, away from ammunition, children, and unauthorized adults



WARNING

Never leave your keys in the lock when the lock is installed on the firearm.

AMMUNITION

WARNING

Using the wrong ammunition in your pistol can result in serious bodily injury and damage to your pistol. Make certain the ammunition you load in the magazine is the same caliber as is marked on the pistol.

WARNING - AMMUNITION AND INDUSTRY STANDARDS

Use only clean, dry factory-loaded ammunition. Old, damaged, wet or oily ammunition may fire at pressures higher than industry standard, causing injury to you and bystanders or damage to your pistol.

Do not use reloaded ammunition in your pistol. Its firing pressures are unknown and may well exceed industry standard, causing injury to you and bystanders or damage to your pistol.

Odd sounds are signs of trouble. If a round “does not sound right” when it goes off, stop firing right away. A bullet may be stuck in the barrel. Firing the pistol in this condition may cause pressures higher than industry standard, causing injury to you and bystanders or damage to your pistol.

If you hear any odd sounds when firing your pistol, stop firing, clear the pistol and “field strip” (or disassemble) the pistol in accordance with the procedures listed in this manual. Once the barrel is removed from the slide, look down the bore. If you do not see light, there is something stuck in the bore. Do not fire the pistol again, and take the pistol to a competent gunsmith or contact the Taurus USA Service Department at 800-327-3776.

WARNING - LEAD AND HAZARDOUS CHEMICAL EXPOSURE

Discharging firearms in poorly ventilated areas, handling, and /or cleaning firearms or handling ammunition can expose you to chemicals including lead which is known to the state of California to cause cancer and birth defects or other reproductive harm. For more information, go to www.P65Warnings.ca.gov

Have adequate ventilation at all times. Wash hands thoroughly after exposure with soap and water.

SHOOTING OR CLEANING GUNS MAY EXPOSE YOU TO LEAD

WARNING

“+P” ammunition can be dangerous. There is a detailed discussion about “+P” and “+P+” ammunition on page 20 of this manual. Until you have read that information, do not fire any ammunition marked “+P” in your pistol.

WARNING

Never fire ammunition marked “+P+” in your pistol. It does not comply with industry standards as to chamber pressures.

WARNING

It is DANGEROUS to fire “+P+” ammunition in any Taurus® firearm, and doing so may result in serious bodily injury or death. The Sporting Arms and Ammunition Manufacturers Institute (SAAMI) does not recognize any “+P+” ammunition at all. These loads operate at unknown pressures.

There are only four calibers that can carry a “+P” rating from SAAMI. They are 38 Special +P, 9mm Luger +P, 38 Super Automatic +P and 45 Automatic +P. There are no other SAAMI approved “+P” loads. Any ammunition in any other caliber marked “+P” is not SAAMI compliant, may be dangerous and should not be used.

Only fire SAAMI rated Plus P (“+P”) ammunition in Taurus® models designated by Taurus for +P use as below. **Firing +P ammunition in other Taurus products may be dangerous and can result in serious bodily injury or death.**

Model 85 small-frame revolver in 38 Special.

Model 850 small-frame revolver in 38 Special.

Model 851 small-frame revolver in 38 Special.

Model 85 Polymer small-frame revolver in 38 Special.

Model 82 medium-frame revolver in 38 Special.

Model 817 compact frame (tracker) revolver in 38 Special.

All firearms chambered in 38 Super Automatic.

All firearms chambered in 45 Automatic (ACP).

All firearms chambered in 9mm Luger.

NOTICE

Even if your Taurus® firearm is rated for Plus-P (“+P”) ammunition, such ammunition generates pressures significantly in excess of the pressures associated with standard ammunition. Such pressures may affect the useful life of the firearm or exceed the margin of safety built into many firearms. Unless you need +P ammunition, do not use it, particularly for practice.

FIREARMS ARE NOT ALL ALIKE

Many makes and models of firearms might LOOK nearly the same. However, they differ widely in design, operation, and in the location and function of various controls. You may access the Taurus® website at TaurusUSA.com to view and print manuals.

“JAMS”

SOMETIMES A CARTRIDGE OR SHELL CASE MAY BECOME “JAMMED” OR STUCK IN THE PISTOL. TO CLEAR THE JAM, (1) POINT THE MUZZLE IN A SAFE DIRECTION, (2) KEEP YOUR FINGER OFF THE TRIGGER AND ON THE MEMORY PAD, (3) REMOVE THE MAGAZINE, THEN (4) PULL BACK THE SLIDE AND LOCK IT TO THE REAR. THE JAMMED CARTRIDGE OR CASE CAN NOW BE REMOVED BY SHAKING OR PICKING IT OUT.



WARNING - FIRING

The slide opens and shuts quickly while firing. Keep face and hands away from rear of slide. Hot brass is ejected quickly and can burn you. Always wear shooting glasses, hat with brim, and hearing protection.



WARNING - ANY GUN MAY FIRE IF DROPPED

If dropped or struck, the pistol may fire.



WARNING

If dropped or struck the firearm should be inspected by a qualified armorer/gunsmith for a complete function check. After the firearm was dropped or struck, mechanisms, including automatic safeties, may not function as intended resulting in accidental death or serious injury.

OPERATING INSTRUCTIONS



1. To remove the magazine press the **magazine catch button**, located near the **trigger guard**, with your thumb.



2. Hold the **magazine** with one of your hands and with the other one insert the cartridges one at a time, pressing them down and to the rear. Insert the **magazine** into the pistol until it is held by the **magazine catch**. If the **magazine** is not correctly inserted into the pistol, it can be dropped when you intend to shoot.



3. Hold the pistol with one hand keeping your finger away from the trigger. With the other hand, pull the **slide** rearward to its limit and release it. The **slide** will go forward under **recoil spring** force and will insert one cartridge in the chamber.



4. The pistol is now ready-to-fire by pulling the **trigger**.

After firing, the **slide** will move back and return forward, ejecting the empty case and feeding another **cartridge** into the chamber from the **magazine**. The pistol is now ready to fire again.



5. After the last round, the **slide** will remain in the open position, held by the **slide stop**. In order to make it return to its rest position pull the **slide** to the rear and release it. (the empty magazine should be removed).

NOTICE

In case of a misfire, i.e., the cartridge primer is struck by the striker, but the round does not fire, this pistol is a double action only pistol which allows you to pull the trigger again without the need to cycle the slide.



WARNING

These Taurus pistols do not have a magazine disconnect (safety). They are capable of firing with magazine removed.

DISASSEMBLY

WARNING

Always wear eye protection that is specified for use with firearms (ANSI Z87.1+) every time you handle your firearm for cleaning and maintenance.

WARNING - UNLOADING

Removing the magazine does not unload the chamber! To unload first make sure the muzzle is pointed in a safe direction and your finger is off the trigger. Next, remove the magazine, then pull the slide to the rear to eject the chambered cartridge. Visually and physically inspect the chamber to ensure it is empty.

WARNING

After removing the magazine, always check the chamber and make sure it is empty.

WARNING

Take care to prevent the forcible ejection of the guide rod assembly and compressed recoil spring.



1. Before and while disassembly, always keep your finger off the **trigger** and point the **muzzle** in a safe direction.



2. Before disassembly, remove the **magazine** by pressing the **magazine catch**, pull the **slide** to the rear, lock it back using the **slide stop** and look and feel inside the **magazine well** and **chamber** to confirm the pistol is empty. An empty firearm cannot fire.



3. On the right side of the pistol is the **take down pin** (see page 13). Using a flathead screw driver, rotate the **take down pin** $\frac{1}{4}$ turn counterclockwise  to unlock the **slide** from the **grip**.

NOTE: You do not have to pull the trigger to disassemble.



4. Holding the **grip** securely, grasp the **slide** and pull forward to separate the **slide** from the **grip**.



5. Release **recoil spring** and **guide rod** from their position on the bottom of the **barrel**.

WARNING

Take care to prevent the forcible ejection of the guide rod assembly and compressed recoil spring.



6. Remove the **barrel** from the **slide** by pulling it to the front and up.

WARNING

No further disassembly is recommended unless done by a qualified gunsmith.



6-ROUND MAGAZINE DISASSEMBLY

A) Use a **punch** to press in on **magazine base cap retainer** (as shown).



B) Slide the **magazine base cap** toward the front of the magazine and remove according to position 1 and 2.

WARNING

Take care to prevent the forcible ejection of the magazine base cap retainer and compressed magazine spring.



WARNING

Always wear eye protection that is specified for use with firearms (ANSI Z87.1+) every time you handle your firearm for cleaning and maintenance.



C) Withdraw **magazine base cap retainer** and **magazine spring** from **magazine tube**. Turn **magazine** right side up and remove the follower.

D) Assemble in reverse order.



1

7-ROUND MAGAZINE DISASSEMBLY

A) Use a flat blade screwdriver to “lift” the **magazine base cap retainer** toward the follower end of the magazine.

B) Slide the **magazine base cap** toward the front of the magazine as shown.

C) Remove the **magazine base cap retainer** and **magazine spring** from the **magazine tube**. Turn magazine right side up and remove the **follower**.

D) Assemble in reverse order.



2

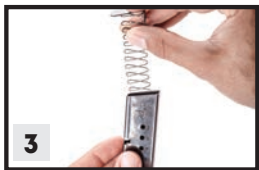

3



4



WARNING

Take care to prevent the forcible ejection of the magazine base cap retainer and compressed magazine spring.



WARNING

Always wear eye protection that is specified for use with firearms (ANSI Z87.1+) every time you handle your firearm for cleaning and maintenance.

ASSEMBLY



1



2



3

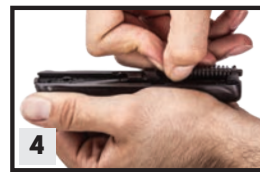

4

1. Replace the **barrel** in the slide pushing it to the rearward position.

2. Place one end of the **spring** over the **guide rod slot** in the slide over the **barrel**. Insert the **guide rod** into the end of the **spring**.

3. While supporting the **spring**, continue to press the **guide rod** into the **spring** and toward the **guide rod slot** located in the front of the **slide**.

4. Ensure the **guide rod** passes through the **guide rod hole** in the **slide**.



5. Secure the **guide rod** base against the lower step of the **barrel**.



6. Before assembling slide to frame, ensure **takedown pin** is in unlocked position.

Align **slide** with slide rails on **frame**. Pull or push **slide** to rear of frame until it stops. Release **slide**.



7. You should cycle the **slide** several times, with no magazine inserted and no rounds in the chamber, to ensure that the barrel/slide/frame relationship is correct.

NOTE: Ensure **takedown pin** is in locked position.



CARE AND MAINTENANCE

The firearm may be cleaned and lubricated under normal conditions with the disassembly steps described in pages 22-24.

In order to keep a firearm safe to use, it must be kept clean and covered with a light film of good quality oil to prevent corrosion. The barrel bore should be cleaned and left free of debris.

For normal cleaning, rub the pistol with a lightly oiled cloth. In the same way, proceed with the bore of the barrel. Excess oil should be removed. Dust should be removed from all crevices with a small clean brush.

Please note that a firearm with laser should not be cleaned in a well or supersonic machine that submerges the firearm as this can damage the laser system.

WARNING

Before cleaning, (1) point the muzzle in a safe direction, (2) keep your finger off the trigger, (3) remove the magazine, then (4) pull back the slide and lock it to the rear, (5) look and feel the magazine well and chamber to confirm the pistol is empty. Never attempt to clean a loaded firearm.

EXPLODED VIEW

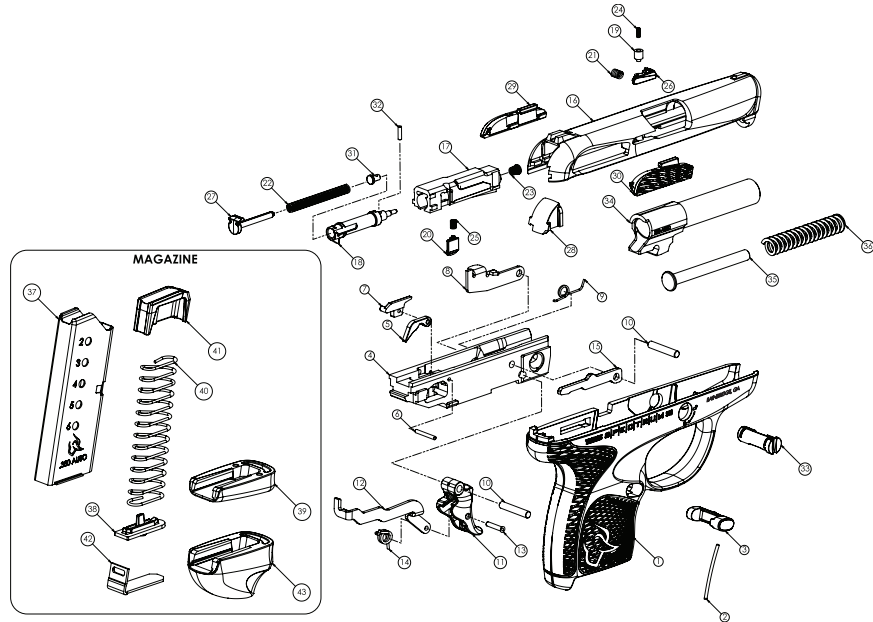

PART LIST

- | | |
|-------------------------------|------------------------------------|
| 1 GRIP | 31 SPRING STOP PLUNGER |
| 2 MAG CATCH SPRING | 32 DOWEL PIN |
| 3 MAGAZINE CATCH | 33 TAKEDOWN PIN |
| 4 FRAME | 34 BARREL |
| 5 STRIKER BLOCK CAM | 35 GUIDE ROD |
| 6 DOWEL PIN | 36 RECOIL SPRING |
| 7 EJECTOR | 37 MAGAZINE TUBE |
| 8 SLIDE STOP LEVER | 38 MAGAZINE BASE CAP RETAINER |
| 9 SLIDE STOP SPRING | 39 MAGAZINE BASE CAP |
| 10 DOWEL PIN | 40 MAGAZINE SPRING |
| 11 TRIGGER | 41 MAGAZINE FOLLOWER |
| 12 TRIGGER BAR | 42 EXTENDED MAGAZINE BASE RETAINER |
| 13 TRIGGER BAR PIVOT PIN | 43 EXTENDED MAGAZINE BASE CAP |
| 14 TRIGGER RETURN SPRING | |
| 15 DISCONNECTOR | |
| 16 SLIDE | |
| 17 STRIKER HOUSING | |
| 18 STRIKER | |
| 19 EXTRACTOR PIVOT PIN | |
| 20 STRIKER BLOCK | |
| 21 EXTRACTOR SPRING | |
| 22 STRIKER SPRING | |
| 23 STRIKER RETURN SPRING | |
| 24 EXTRACTOR PIVOT PIN SPRING | |
| 25 STRIKER BLOCK SPRING | |
| 26 EXTRACTOR | |
| 27 SLIDE CAP RETAINER | |
| 28 SLIDE CAP | |
| 29 LEFT SLIDE INSERT | |
| 30 RIGHT SLIDE INSERT | |

TAURUS SERVICE

Should your firearm require adjustment or repair contact our Customer Care department at 800-327-3776.

Please follow these suggestions to expedite service in the United States to return any firearm to us for adjustment or repair.

1. Federal law permits you to return your firearm to the manufacturer for service via common carriers. However, state and local firearms laws vary greatly; you should consult your local prosecuting attorney regarding any restrictive laws in your jurisdiction regarding your shipment or receipt of firearms. With the above in mind, it is strongly recommended that any firearm sent to us for repair be sent through a federally licensed dealer.

2. All firearms must be shipped to us prepaid. WE WILL NOT ACCEPT COLLECT SHIPMENTS.

3. Warranty Service: If your product is covered under the Taurus® Limited Lifetime Warranty (<https://warranty.taurususa.com>) or was manufactured prior to January 1, 2017, you must contact Taurus to receive warranty service. You may contact Taurus by calling 800-327-3776, logging onto <https://taurususa.com>, or in writing: Taurus, Attn: Warranty Service, 100 Taurus Way, Bainbridge, GA 39817. Please include a description of the claimed defect, along with your name, address, telephone number, model and serial number of your firearm, proof of purchase, and date of purchase.

4. FIREARMS MUST BE SHIPPED UNLOADED. Double check the chambers of your firearm before shipping. If firearms are sent to Taurus in a loaded condition, we are required by law to notify the Federal authorities.

5. DO NOT include telescopic sights, custom grips, holsters, or other accessories with any firearm shipped to us.

PARTS

Firearms require periodic maintenance, inspection, adjustment and repair. If your pistol has a malfunction, be safe. Stop firing, “clear” and unload the pistol and take it to a qualified gunsmith. Before shooting it again, contact our Customer Care department if you have any questions.

If water, sand, or other foreign matter gets in your pistol, field strip it (see pages 22-24) and thoroughly clean it. Failure to keep your firearm clean and in proper working order can be dangerous.

Our Customer Care department maintains a full stock of replacement parts for current Taurus firearms. Even though most gunsmiths have the knowledge, training and ability to make the necessary repairs to your firearm, the skill and workmanship of any particular gunsmith is totally beyond our control. Should your firearm require service, return it to our Customer Care department.

Remember, unauthorized adjustments or parts replacement can void your warranty. If you choose to have someone else do the required work, the purchaser and/or installer of parts must accept full responsibility for the correct adjustment and function of the firearm.



TAURUS® LIMITED LIFETIME WARRANTY

Taurus® hereby provides the following **LIMITED LIFETIME WARRANTY**, to the original purchaser of the enclosed Taurus firearm subject to the terms and conditions set forth below. **THIS IS THE ONLY WARRANTY EXTENDED BY TAURUS COVERING THIS FIREARM.**

What does the warranty cover and what is its duration?

Taurus warrants to the original purchaser that the enclosed firearm was made free of defects in material, function, and workmanship. Taurus promises to remedy any defect in material, function or workmanship for the entire time that the original purchaser owns the firearm. This warranty covers the firearm's finish, grips, magazines, sights or accessories for the first year. Any claims of defect related to lasers must be directed to the manufacturer of the laser. This warranty terminates automatically upon the transfer of this firearm to any individual or entity other than the original purchaser.

Disclaimer and Limitation of Remedy.

ANY IMPLIED WARRANTIES OF MERCHANTABILITY IMPARTED BY STATE LAW WILL BE LIMITED TO ONE (1) YEAR.

Some States do not allow limitations on how long an implied warranty lasts, so the above-limitation may not apply to you.

ANY AND ALL INCIDENTAL AND CONSEQUENTIAL DAMAGES ARE EXPRESSLY DISCLAIMED UNDER ALL CIRCUMSTANCES.

Some States do not allow the exclusion or limitation of incidental or consequential damages, so the above limitation or exclusion may not apply to you. This **LIMITED LIFETIME WARRANTY** gives you specific legal rights, and you may also have other rights which vary from State to State.

Taurus will not be responsible for:

1. Defects or malfunctions resulting from careless handling, unauthorized adjustments or modifications.
2. Use of defective or improper ammunition, reloaded ammunition, corrosion, neglect, abuse, ordinary wear and tear or unreasonable use.
3. Criminal misuse, negligence or use under the influence of drugs or alcohol.

How do you obtain warranty service?

The warranty becomes effective only if activated by the original purchaser within thirty (30) days of the purchase date by registering online at: <https://warranty.taurususa.com> or by calling Taurus at 800-327-3776.

You must contact Taurus to receive warranty service. You may contact Taurus by calling 800-327-3776, logging onto <https://taurususa.com>, or in writing: Taurus, Attn: Warranty Service, 100 Taurus Way, Bainbridge, GA 39817. Please include a description of the claimed defect, along with your name, address, telephone number, model and serial number of your firearm, proof of purchase, and date of purchase.

IMPORTANT DO NOT DISCARD

KEEP THIS MANUAL WITH THE FIREARM
UPON CHANGE OF OWNERSHIP.

TAURUS INTERNATIONAL MANUFACTURING, INC.

100 Taurus Way
Bainbridge, GA 39817
Telephone: 1-800-327-3776

WARNING: This product contains chemicals known
to the State of California to cause cancer, birth defects
or other reproductive harm.

TAURUSUSA.COM

MKG50055 REV.7

