

APX

PISTOL
USER MANUAL

 BERETTA

CONTENTS

USER MANUAL

BASIC SAFETY RULES	6
CONTROLS AND COMPONENTS..	10
AMMUNITION	12
LOADING AND FIRING	13
DESCRIPTION	18
GENERAL OPERATION	24
MAINTENANCE	34
TROUBLESHOOTING.....	36
PART LIST	38

MANUALE DI ISTRUZIONI

NORME DI SICUREZZA

BASILARI	44
COMANDI E COMPONENTI	
PRINCIPALI.....	48
MUNIZIONAMENTO	50
CARICARE, SPARARE, SCARICARE	51
DESCRIZIONE	56
FUNZIONAMENTO	62
MANUTENZIONE.....	73
RICERCA DEI GUASTI.....	75
LISTA PARTI.....	76

MODE D'EMPLOI

REGLES DE SECURITE

DE BASE	82
COMMANDES ET COMPOSANTS...	86
MUNITIONS	88
CHARGER ET TIRER	89
DESCRIPTION	94
FONCTIONNEMENT GÉNÉRAL...	100
ENTRETIEN.....	111
INCONVENIENTS, CAUSES ET REMEDES	113
LISTE DES PIÈCES	114

MANUAL DE INSTRUCCIONES

NORMAS BÁSICAS DE

SEGURIDAD	120
CONTROLES Y COMPONENTES ..	124
MUNICIONES	126
CARGAR Y DISPARAR.....	127
DESCRIPCIÓN.....	132
FUNCIONAMIENTO GENERAL...	138
MANTENIMIENTO	149
INCONVENIENTES, CAUSAS Y REMEDIOS.....	151
LISTA DE PIEZAS	152

BEDIENUNGSHANDBUCH

GRUNDLEGENDE

SICHERHEITSGESETZE	158
SICHERUNGEN UND BAUTEILE ..	162
MUNITION.....	164
LADEN UND SCHIESSEN	165
BESCHREIBUNG.....	170
ALLGEMEINER BETRIEB	176
PFLEGE.....	186
STÖRUNGEN, URSACHEN UND ABHILFE.....	189
TEILELISTE	190

WARNING, CAUTION and Notice headings are defined as follows:

 **WARNING:**

The purpose of a **WARNING** is to draw attention to a potential dangerous situation that could result in personal injury.

 **CAUTION:**

A **CAUTION** concerns potential damage to firearm.

 **Notice:**

A **NOTICE** highlights important procedures and statements that require more emphasis than general text.

This manual and its figures refer to the APX Full size pistol. The terms right and left are intended to describe the firearm when it is grasped.

This manual's contents may be changed without notice.

⚠ Notice: always keep this manual with your firearm. Include it with the pistol when it changes ownership or when it is loaned or presented to another person.

⚠ Notice: The Manufacturer and/or its Local Official Distributors assume no responsibility for product malfunction or for physical injury or property damage resulting in whole or in part from criminal or negligent use of the product, improper or careless handling, unauthorized modifications, use of defective, improper, hand-loaded, reloaded or remanufactured ammunition*, customer abuse or neglect of the product, or other influences beyond manufacturer's direct and immediate control.

* See paragraph "Ammunition".

⚠ WARNING: Always ensure safety – if present – is engaged until ready to fire. A safety that is not fully engaged will not prevent firearm discharge.

⚠ WARNING: ALL FIREARMS HAVE LETHAL POTENTIAL. READ THE BASIC SAFETY RULES CAREFULLY AND UNDER-STAND THEM FULLY BEFORE ATTEMPTING TO USE THIS FIREARM.

⚠ Notice: In addition to the Basic Safety Rules, there are other Safety Rules pertaining to the loading, unloading, disassembly, as-sembly and use of this firearm, located throughout this manual.

⚠ WARNING: READ THE ENTIRE MANUAL CAREFULLY BEFORE USING THIS FIREARM. MAKE SURE THAT ANY PERSON USING OR HAVING ACCESS TO THIS FIREARM READS AND UNDERSTANDS ALL OF THIS MANUAL PRIOR TO USE OR ACCESS.

⚠ Notice: we recommend the use of original Beretta spare parts and accessories. The use of other manufacturer's spare parts and accessories could cause malfunctions and/or breakages that will not be covered by the beretta warranty.

BASIC SAFETY RULES

⚠ WARNING: PLEASE READ THIS MANUAL BEFORE HANDLING YOUR FIREARM.

⚠ WARNING: FIREARMS CAN BE DANGEROUS AND CAN POTENTIALLY CAUSE SERIOUS INJURY, DAMAGE TO PROPERTY OR DEATH, IF HANDLED IMPROPERLY. THE FOLLOWING SAFETY RULES ARE AN IMPORTANT REMINDER THAT FIREARM SAFETY IS YOUR RESPONSIBILITY.

1. NEVER POINT A FIREARM AT SOMETHING THAT IS NOT SAFE TO SHOOT.

Never let the muzzle of a firearm point at any part of your body or at another person. This is especially important when loading or



unloading the firearm. When you are shooting at a target, know what is behind it. Some bullets can travel over a mile. If you miss your target or if the bullet penetrates the target, it is your responsibility to ensure that the shot does not cause unintended injury or damage.

2. ALWAYS TREAT A FIREARM AS IF IT WERE LOADED.

Never assume that a firearm is unloaded. The only certain way to ensure that a firearm has the chamber(s) empty is to open the chamber and visually and physically examine the inside to see if a round is present. Removing or unloading the magazine will not guarantee that a firearm is unloaded or cannot fire. Firearms can be checked by cycling or removing all rounds

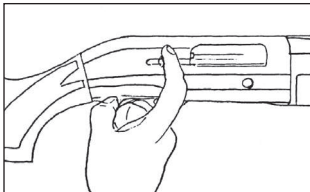
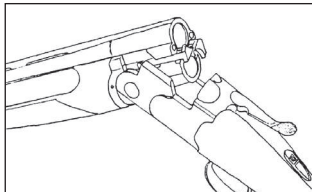
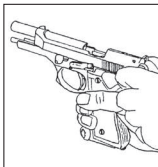

and by then opening and inspecting the chamber so that a visual inspection of the chamber for any remaining rounds can be made.

3. STORE YOUR FIREARM SO THAT CHILDREN CANNOT GAIN ACCESS TO IT.

It is your responsibility to ensure that children under the age of 18 or other unauthorized persons do not gain access to your firearm. To reduce the risk of accidents involving children, unload your firearm, lock it and store the ammunition in a separate locked location. Please note that devices intended to prevent accidents - for example, cable locks, chamber plugs, etc. - may not prevent use or misuse of your firearm by a determined person. Firearm storage in a steel gun safe may be more appropriate to reduce the likelihood of intentional misuse of a firearm by an unauthorized child or person.

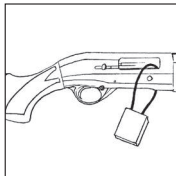
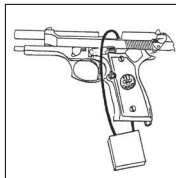

4. NEVER SHOOT AT WATER OR AT A HARD SURFACE.

Shooting at the surface of water or at a rock or other hard surface increases the chance of ricochets or fragmentation of the bullet or shot, which can result in the projectile striking an unintended or peripheral target.



5. KNOW THE SAFETY FEATURES OF THE FIREARM YOU ARE USING, BUT REMEMBER: SAFETY DEVICES ARE NOT A SUBSTITUTE FOR SAFE HANDLING PROCEDURES.

Never rely solely on a safety device to prevent an accident. It is imperative that you know and use the safety features of the particular firearm you are handling, but accidents can best be prevented by following the safe handling procedures described in these safety rules and elsewhere in the product manual. To further familiarize yourself with the proper use of this or other firearms, take a Firearms Safety Course taught by an expert in firearms use and safety procedures.

6. PROPERLY MAINTAIN YOUR FIREARM.

Store and carry your firearm so that dirt or lint does not accumulate in the working parts. Clean and oil your firearm, following the instructions provided in this manual, after each use to prevent corrosion,

damage to the barrel or accumulation of impurities which can prevent use of the gun in an emergency. Always check the bore and chamber(s) prior to loading to ensure that they are clean and free from obstructions. Firing with an obstruction in the barrel or chamber can rupture the barrel and injure you or others nearby. In the event you hear an unusual noise when shooting, stop firing immediately, engage the manual safety and unload the firearm. Make sure the chamber and barrel are free from any obstruction, like a bullet blocked inside the barrel due to defective or improper ammunition.



Make sure the chamber and barrel are free from any obstruction, like a bullet blocked inside the barrel due to defective or improper ammunition.

7. USE PROPER AMMUNITION.

Only use factory-loaded, new ammunition manufactured to industry specifications: CIP (Europe and elsewhere), SAAMI® (U.S.A.). Be certain that each round you use is in the proper caliber or gauge and type for the particular firearm. The caliber or gauge of the firearm is clearly marked on the barrels of shotguns and on the slide or barrel of pistols. The use of reloaded or remanufactured ammunition can increase the likelihood of excessive cartridge pressures, case-head ruptures or other defects in the ammunition that can cause damage to your firearm and injury to yourself or others nearby.

8. ALWAYS WEAR PROTECTIVE GLASSES AND EARPLUGS WHEN SHOOTING.

The chance that gas, gunpowder or metal fragments will blow back and injure a shooter who is firing a gun is rare, but the injury that can be sustained in such circumstances can be severe, including the possible loss of eyesight. A shooter must always wear impact resistant shooting glasses when firing any firearm. Earplugs or other high-quality hearing protectors help reduce the chance of hearing damage from shooting.



9. NEVER CLIMB A TREE, FENCE OR OBSTRUCTION WITH A LOADED FIREARM.

Open and empty the chamber(s) of your firearm and engage the manual safety before climbing or descending a tree or before climbing a fence or jumping over a ditch or other obstruction. Never pull or push a loaded firearm toward yourself or



another person. Always unload a firearm, visually and physically check to see that the magazine, loading mechanism and chamber are unloaded, and action is open before handing it to another person. Never take a firearm from another person unless it is unloaded, visually and physically checked to confirm it is unloaded, and the action is open.

10. AVOID ALCOHOLIC BEVERAGES OR JUDGMENT/REFLEX IMPAIRING MEDICATION WHEN SHOOTING.

Do not drink and shoot. If you take medication that can impair motor reactions or judgment, do not handle a firearm while you are under the influence of the medication.



11. NEVER TRANSPORT A LOADED FIREARM.

Unload a firearm before putting it in a vehicle (chamber empty, magazine empty). Hunters and target shooters should load their firearm only at their destination, and only when they are ready to shoot. If you carry a firearm for self-protection, leaving the chamber unloaded can reduce the chance of an unintentional discharge.



12. LEAD WARNING.

Discharging firearms in poorly ventilated areas, cleaning firearms, or handling ammunition may result in exposure to lead and other substances known to cause birth defects, reproductive harm, and other serious physical injury. Have adequate ventilation at all times. Wash hands thoroughly after exposure.

⚠ WARNING: It is **YOUR** responsibility to know and abide by Federal, State and Local laws governing the sale, transportation and use of firearms in your area.

⚠ WARNING: This firearm has the capability of taking your life or the life of someone else! Always be extremely careful with your firearm. An accident is almost always the result of not following basic firearm safety rules.

ESPECIALLY FOR U.S. CONSUMERS:

For information about Firearm Safety Courses in your area, please visit the National Rifle Association's web site at www.nra.org.

CONTROLS AND COMPONENTS

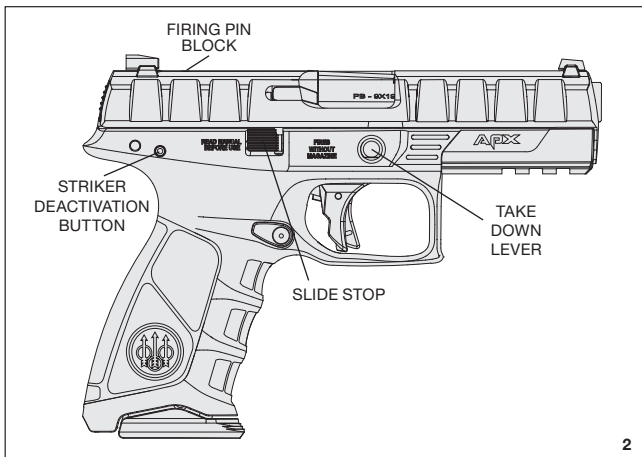
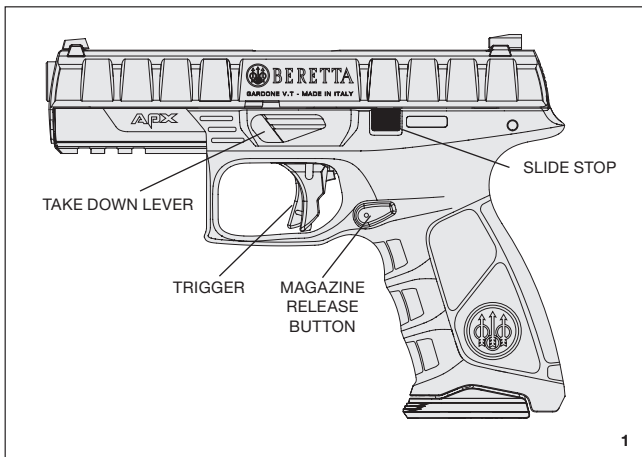

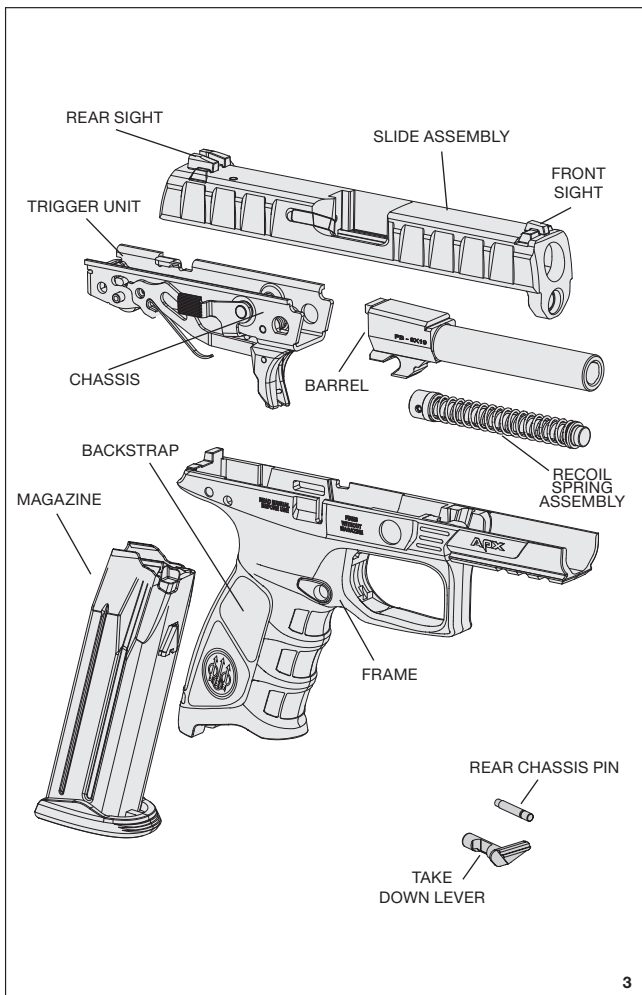

AMMUNITION

AMMUNITION (CARTRIDGE)

NOTICE: Beretta specifically disclaims responsibility for any damage or injury occurring with, or as the result of, the use of faulty, non-standard, “remanufactured,” hand-loaded or reloaded ammunition, or cartridges other than those for which the firearm was originally chambered. Serious damage or injury, even death, could result from the use of incorrect ammunition, from firing against bore obstructions and from propellant overloads. Use of improper ammunition, such as listed previously will void the manufacturer’s warranty. Use only high-quality, commercially-manufactured ammunition made in accordance with CIP (Europe and elsewhere) or SAAMI® (USA) standards. Be certain that the ammunition is the appropriate caliber and loading for the firearm and is clean, dry and in good condition. The pistol caliber is stamped on the back of the barrel, visible from the ejection port.

⚠ WARNING: Carefully inspect each cartridge before it is loaded in the magazine. Be certain the cartridge cases are not split or deformed, and that the cartridges do not possess

any other dents or defects. This warning even applies to factory ammunition.

Do not fire old ammunition. Primers, powder, cartridge cases, and bullets can deteriorate with time and cause damage to the firearm, or injury to the shooter or others.

⚠ WARNING: The extended use of +P or +P+ ammunition may decrease component part service life expectancy. **DO NOT** use sub-machine gun ammunition because the chamber pressure may reach or exceed proof load pressure. Lead bullets have a tendency to cause bore leading, which may dramatically increase the discharge pressure. Be sure to remove all chamber and bore lead accumulation after each use. **DO NOT** shoot cartridges with jacketed bullets through a barrel previously fired with lead bullets before the bore is thoroughly delead.

DRY FIRING & “DUMMY” ROUNDS

Dry firing is defined as firing a firearm with no ammunition in

the chamber. Long term dry firing your Beretta APX pistol may result in damage to the striker. “Snap Caps” (inert chamber inserts that allow a firearm to be dry-fired without damaging the action) are available at most gun stores for those who wish to practice firing without live ammunition.

 **CAUTION:** “Dummy Rounds” with empty primer pockets are suitable for loading/unloading practice but **DO NOT PROTECT** the striker tip during dry firing.

LOADING AND FIRING

 **WARNING:** Whenever a live round is in the chamber, this pistol can fire, even if the magazine is empty or has been removed, unless equipped with a magazine disconnect safety.

 **WARNING:** Before loading the firearm, become familiar with the following loading procedures without the use of ammunition. Never handle a loaded firearm until you are familiar with the load-

ing procedures.

 **WARNING:** Always keep your finger away from the trigger until you are prepared to fire.

 **WARNING:** LOAD THE CHAMBER ONLY WHEN READY TO FIRE.

LOADING THE MAGAZINE

 **WARNING:** Be sure that you have the correct cartridges for your pistol.

To load the magazine: Remove it from the pistol by depressing the magazine release button.

Hold the magazine in one hand. With the other hand, place a cartridge on the magazine follower in front of the feed lips at the top of the magazine. Press the cartridge down onto the follower and slide the cartridge under the feed lips until it is seated fully inside the magazine body.

Repeat process until magazine is fully loaded. The witness holes on the back of the magazine allow for visual counting of cartridges.

 **CAUTION:** Do not try to force more than the maximum number of rounds indicated for your particular pistol into the magazine. An overloaded magazine may not function properly.

LOADING THE PISTOL AND THE FIRING CHAMBER

 **WARNING:** Beretta assumes no responsibility for any injury or property damage resulting from improper or careless handling, intentional or accidental discharge of the firearm.

 **WARNING:** Be sure that the obstruction check has been completed prior to loading.

 **WARNING:** Point the firearm in a safe direction. Do not touch the trigger until you are ready to fire and are sure of your target and backstop.

The firing chamber is the portion of the barrel into which the cartridge is fed. The firing

chamber may be loaded in one of two ways:

1. MANUALLY LOADING FROM MAGAZINE

Completely push the loaded magazine into the pistol grip to insure magazine housing engagement. Pull back the slide and release it. The slide will automatically pick up a cartridge from the top of the magazine and feed it into the chamber.

2. AS LONG AS THERE IS AMMUNITION IN THE MAGAZINE, A PISTOL WHICH IS LOADED AND FIRED, WILL AUTOMATICALLY PICK UP THE NEXT ROUND AND FEED IT INTO THE FIRING CHAMBER.

To replace a round of a magazine which has been chambered from the magazine; (remember that you are handling a loaded firearm with a live round in the chamber):

Make sure your finger is not on the trigger or inside the trigger guard.

Remove the magazine from the pistol by depressing the magazine release button.

Insert one more cartridge into the magazine.

Completely push the loaded magazine into the pistol grip to

insure magazine housing engagement.

⚠ WARNING: THE FIREARM YOU ARE HANDLING AT THIS POINT IS LOADED WITH A LIVE ROUND IN THE CHAMBER. Keep your finger away from the trigger whenever you do not intend to fire.

UNLOADING

⚠ WARNING: Always unload the firearm whenever you do not intend to shoot.

⚠ WARNING: Be certain the pistol is pointed in a **SAFE** direction. Keep your finger away from the trigger.

Keeping the firearm pointed in a safe direction and fingers away from the trigger, remove the loaded magazine from the frame. Always using safety precautions grasp the slide serrations with thumb and index finger and fully retract the slide to remove the chambered cartridge.

⚠ WARNING: Always visually inspect the firing chamber to ensure that it is empty. The chamber is empty when

no cartridge is visible when looking from the ejection port into the open chamber.

⚠ WARNING: If you are ejecting unfired cartridges, use extreme care to be sure they are ejected onto an appropriate surface. Never attempt to housing cartridges or fired cartridge cases as they fall.

⚠ WARNING: Never allow anything to come in contact with the primer of unfired ammunition. Doing so could cause the ammunition to explode.

With the slide in locked position, make sure that you visually and physically inspect the chamber to ensure that it is empty.

⚠ WARNING: Releasing the fully retracted slide when a loaded magazine is in the pistol will feed a cartridge into the pistol's firing chamber and the pistol will be able to fire immediately.

⚠ Notice: It is recommended to store the firearm unloaded, slide closed, with the magazine empty.

UNLOADING THE MAGAZINE

To unload the magazine:

Grasp the magazine with one hand around the magazine box, bottom down and front end forward.

With the tip of the thumb firmly press down on the cartridge rim and push towards the front of magazine box.

As the cartridge moves forward, tip it slightly upward with the index finger.

Repeat until the magazine is unloaded.

FIRING

⚠ WARNING: Beretta assumes no responsibility for any injury or property damage resulting from improper or careless handling, intentional or accidental discharge of the firearm.

⚠ WARNING: Be certain the firearm is pointed in a **SAFE** direction. Never put your finger on the trigger unless you intend to shoot.

⚠ WARNING: High-quality

eye and ear protection should be worn by all present when firing any firearm.

To fire the pistol, insert the magazine into the pistol and load a round into the chamber.

Without placing the finger on the trigger or inside the trigger guard, point the pistol at the intended target. Aim the pistol by aligning the front sight in the notch of the rear sight. Point the front sight in the center of the target. The front sight should be in focus, the target and the rear sight slightly blurred or out of focus.

⚠ WARNING: THE PISTOL IS NOW READY TO FIRE.

WHEN YOU ARE READY TO FIRE:

Place your index finger inside the trigger guard.

⚠ WARNING: Ensure that fingers or other parts of the hands and the face are kept away from the slide. Not respecting this warning can lead to serious injury. During the firing cycle, the slide moves to the rear violently and with great energy. Ensure that the other hand is kept away from the muzzle of the barrel.

Gently squeeze the trigger, be-

ing careful not to upset the alignment of the front and rear sights. THE PISTOL WILL FIRE. The discharge will force the slide and barrel to the rear, which will in turn eject the fired cartridge case, reset the striker and compress the recoil spring. Then the slide will close, feeding the next cartridge from the magazine into the chamber.

⚠ WARNING: THE PISTOL IS STILL LOADED, COCKED AND READY TO FIRE. Keep your finger away from the trigger whenever you do not intend to fire.

When the last round has been fired the slide will remain open.

To fire again, remove the empty magazine and insert a loaded one.

Push the slide stop down to load a cartridge into the chamber and shoot.

When you have completed shooting, remove the magazine, check that the firing chamber is empty, see “UNLOADING” (page 15) and close the slide pushing the SLIDE STOP again.

⚠ WARNING: Always unload the firearm immediately after shooting is completed. Never

store a loaded firearm. To store the pistol see the paragraph “STORAGE” (page 35).

⚠ WARNING: If while firing the trigger is pulled and the firearm does not immediately fire: CEASE FIRING IMMEDIATELY and do the following:

A squib load is when a bullet is not fired with sufficient energy to leave the barrel and may create a dangerous obstruction.

If a squib load has occurred keep the firearm pointed in a safe direction.

With the pistol pointed in a SAFE direction, wait one (1) full minute.

After one (1) full minute has elapsed, completely unload the firearm by following the “UNLOADING” instructions in this manual (page 15).

Carefully inspect your ammunition. Immediately refer to a qualified gunsmith if the striker indent on a fired cartridge’s primer is light, off-center or does not exist. Following the “FIELD STRIPPING” instructions (page 26), field strip the pistol and look down the barrel to make sure that no obstruction exists. If a barrel obstruction is detected, a qualified gunsmith must remove

the obstruction and inspect the pistol before it can be fired.

⚠ WARNING: If another cartridge is fired into an obstructed barrel, catastrophic failure can result.

⚠ WARNING: If, while firing, you hear a change in the sound of a fired cartridge, or feel a change in the amount of recoil, or detect any other irregularity, CEASE FIRING IMMEDIATELY and do the following:

Keep the firearm pointed in a SAFE direction. A “squib load” may have occurred. A “squib” occurs when a cartridge fires, but with insufficient force to drive the bullet out of the barrel. This can result in a dangerous bore obstruction.

With the gun pointed in a SAFE direction, completely unload the firearm by following the ‘UNLOADING’ (page 15). Following the ‘FIELD STRIPPING’ instructions (page 26), field strip the pistol and look down the barrel to make sure that no obstruction exists.

⚠ WARNING: Never attempt to reuse or fire ammunition that did not fire the first time. Dispose of unfired or damaged ammunition properly, per the ammunition manufacturer’s recommendation.

DESCRIPTION

The Beretta APX, utilizing a removable, serialized chassis, can be easily modified with replaceable frame and is simple to disassemble and maintain. Ease of use was the key driver in the development of the APX. The APX’s extremely low profile, snag free design makes it easy to carry and draw from holster. To accommodate right or left-handed use, the APX’s magazine release button can be easily reversed. The light, durable frame employs modern thermoplastic technology through the use of fiberglass reinforced technopolymer.

SAFETY FEATURES

Striker deactivation button

Beretta APX pistols have a unique feature that allows the user to deactivate the internal striker mechanism prior to disassembly. This means the pistol can be disassembled WITHOUT PULLING THE TRIGGER.

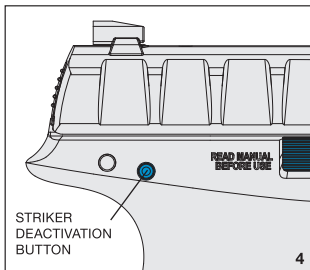

through inertia, in the event the pistol is dropped.

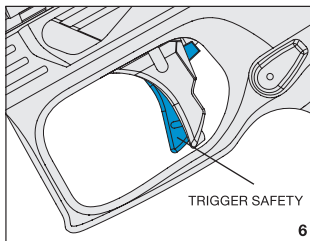

Firing pin block

Beretta APX pistols have a striker blocking device that prevents forward movement of the striker unless the trigger is completely pulled.

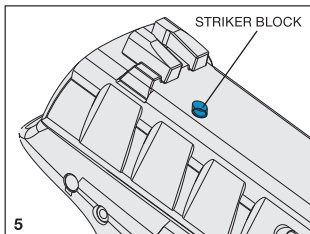

When the trigger is intentionally pulled, the trigger safety is instantly deactivated.

Out of battery safety

Beretta APX pistols have a mechanism which disconnects the trigger bar when the slide is out of battery.

Thumb safety

The Beretta APX pistols may be configured with thumb safety by changing the frame and the rear chassis pin and installing thumb safety right, Thumb safety left, Safety lever retaining pins, safety plunger, and safety plunger spring.

Trigger safety

The trigger safety stops the trigger from traveling rearward

STANDARD SAFETY FEATURES	Striker deactivation button
	Firing pin block
	Trigger safety
	Out of battery safety
OPTIONAL SAFETY FEATURES	Thumb safety
	Loaded chamber indicator
	Magazine disconnect safety

Loaded Chamber Indicator

Beretta APX pistols may have a loaded chamber indicator which protrudes from the top surface of the slide when a case is in the chamber. Loaded chamber indicator gives visual and tactile indication that there is no cartridge in the chamber.

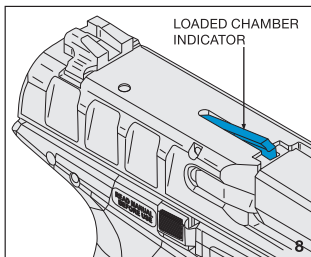
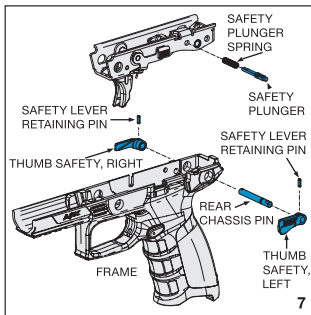

Magazine disconnect safety

To prevent firing even in the case of dropping or loss of the magazine, APX pistols may be provided with a magazine dis-

connect safety configuration. Where legal requirements ask for, the gun will be equipped with this device.

OPERATIONAL FEATURES

Semiautomatic firing

Beretta APX pistols will automatically reload after each round is fired, as long as there are cartridges in the magazine.

Barrel locking system

The barrel and slide are locked together as a unit at the time of discharge. As they move to the rear during recoil, the barrel cam operates on the barrel disconnect causing the barrel to disengage from the slide and allows the slide to continue its rearward travel.

Striker fired trigger system

When the trigger is pulled the trigger bar rotates the firing pin block lever. This lever, in turn, rotates the cocking lever to the rear and the cocking lever pushes the striker against the striker spring. Just before full trigger travel is reached, the firing pin block lever pushes the firing pin block out of engagement and the cocking lever releases the striker. After the striker reaches

its full forward position the striker return spring rebounds the striker to a neutral position so the firing pin block is automatically activated when the trigger is released.

Magazine

The Beretta APX pistol has an easily removable double stack magazine that allows for rapid reloading of the pistol. The 9x19 mm magazine capacity is 17 rounds; the 9mm x21 IMI magazine capacity is 15 rounds and .40 S&W magazine capacity is 15 rounds.

Slide stop

The SLIDE STOP is a lever that holds the slide open after the last round is fired. This allows the user to immediately determine that the pistol does not have a round in the chamber or in the magazine.

The APX's slide stop is external and ambidextrous.

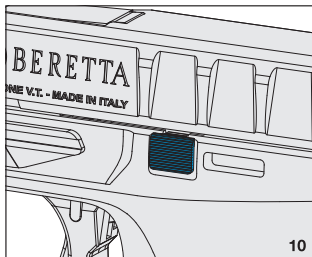
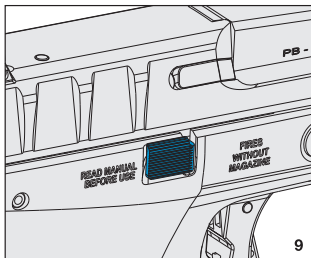

Interchangeable and adjustable low profile sights

The high definition 3-dot sight system is designed for quick target acquisition.

Sights are made of steel and dovetailed to the slide.

ERGONOMIC AND MODULAR FEATURES

Technopolymer frame

By using fiberglass reinforced technopolymer, Beretta has developed a light and technically advanced pistol with an ergonomic shape.

Ergonomic and modular backstrap

The ergonomic frame features an optimal grip angle for sight alignment and target acquisition. Both the front and the rear grip surface

es feature a comfortable checkered surface to ensure a firm hold. Three different sizes (small, medium and large) of backstraps allows the customization of the grip for different hand sizes.

Reversible magazine release button

The magazine release button can be installed for right- or left-hand use depending on shooter preference (page 29).

Slide stop

The ambidextrous SLIDE STOP is activated by the magazine follower. To hold the slide to the rear it is necessary to either insert a magazine and rack the slide to the rear, or press the slide stop up while retracting the slide in order to lock the slide to the rear. To close the slide on an empty chamber, push down the slide stop and the slide will be automatically released.

Interchangeable frame and serialized chassis

The internal chassis of this pistol is serialized. This allows frame to be exchanged or customized without affecting the serialized part.

⚠ WARNING: Do not attempt to alter your pistol's firing mechanism. Modifying these internal parts can cause an unsafe condition.

⚠ WARNING: Altering the internal parts of your pistol's firing mechanism voids the manufacturer's warranty.

Field stripping, cleaning and re-assembly

(see page 26-27)

The pistol is designed for quick and simple field stripping and to avoid unintentional disas-

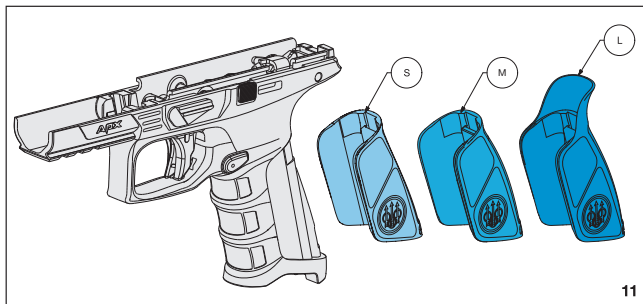

SPECIFICATIONS AND TECHNICAL DATA

Model	APX	APX LONG BARREL
Barrel length	4.25 in / 108 mm	4.76 in / 121 mm
Overall length	7.56 in / 192 mm	8.07 in / 205 mm
Overall width	1.30 in / 33 mm	1.30 in / 33 mm
Overall height	5.60 in / 142 mm	5.60 in / 142 mm
Sight radius	6.30 in / 160 mm	6.30 in / 160 mm
Approximate weight unloaded with empty magazine	9x19 mm 27.5 oz / 780 grams 9x21 IMI 27.5 oz / 780 grams .40 S&W 28 oz / 800 grams	9x19 mm 29 oz / 820 grams 9x21 IMI 29 oz / 820 grams .40 S&W 29.3 oz / 830 grams
Magazine	9x19 mm, 17 rounds - 9x21 IMI or .40 S&W 15 rounds	
Caliber	9x19 mm, 9x21 IMI or .40 S&W	
Rifling	R.H. - 6 grooves	
Rifling Pitch	9x19 mm 10 in / 250 mm 9x21 IMI 10 in / 250 mm .40 S&W 15.75 in / 400 mm	
General Operation	Semiautomatic, short recoil system	
Locking System	Cam operated, tilt-barrel, locked breech	
Action	Striker fired	
Front sight	Steel, blade, dovetailed to slide	
Rear sight	Steel, notched bar, dovetailed to slide	
Chassis	Stainless steel	
Grip frame housing	Fiberglass reinforced polymer	
Slide	Steel with black Nitride finishing	
Barrel	Steel with black Nitride finishing	
Safety	Trigger safety Striker deactivation button Firing pin block Out of battery safety	
Optional Safeties	Thumb safety Loaded Chamber Indicator Magazine safety	

sembly. Reassembly is easy and intuitive.

GENERAL OPERATION

The Beretta APX pistol is a semiautomatic firearm using a cam operated, tilt-barrel, locking system. When the pistol is fired, the recoil energy causes the barrel and slide assembly to move to the rear. After a short distance, the barrel is forced down and is stopped by the operation of the barrel cam and barrel disconnecter interface. The slide continues its rearward travel under inertia, extracting the fired case from the barrel and ejecting it through the ejection port. The recoil spring pushes the slide forward, feeding the next cartridge from the magazine into the barrel chamber. Continued forward movement causes the barrel cam to raise the barrel into its locked position in the slide and engage the striker with the cocking lever. The slide is designed to remain open after the last cartridge has been fired and the spent shell casing ejected.

LOAD CHECK

⚠ WARNING: Keep your finger **OFF OF THE TRIGGER** and the barrel pointed in a **SAFE** direction when checking to be certain your **APX pistol is unloaded.**

To visually check that your pistol is unloaded, carefully follow the steps below.

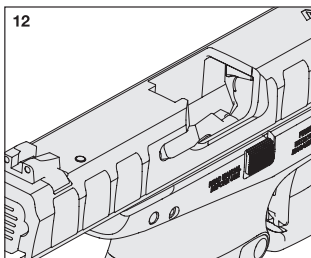

Remove the magazine by depressing the magazine release button.

Retract the slide and visually inspect the cartridge chamber. The pistol is unloaded when no cartridge is visible when looking into the open chamber.

For safety, you should...

Always visually check to see that the chamber is unloaded. Never assume that a firearm is unloaded (even with a gun that is new and in its original packaging).

Never point a firearm toward yourself or another person. Lock the slide in the open position and remove the magazine before handing the pistol to another person. Never take any pistol from another person unless the slide has been locked open, the magazine has been removed and the chamber has been visually checked to confirm it is unloaded.

LOCKING THE SLIDE TO THE REAR

⚠ WARNING: Keep your finger OFF OF THE TRIGGER and the barrel pointed in a SAFE direction.

⚠ WARNING: Always keep your finger away from the ejection port.

Locking the slide in the open position can be accomplished in 2 ways.

1) insert an empty magazine into the pistol. Retract the slide until the slide locks in the open position.

⚠ Notice: The slide will be released when pulled to the rear if a LOADED magazine is inserted.

⚠ Notice: The slide will be released when pulled to the rear if NO magazine is inserted.

⚠ Notice: The slide will remain locked in the open position when the magazine is removed.

2) with no magazine in the pistol, retract the slide while pressing up on the SLIDE STOP to lock the slide in the open position.

FIELD STRIPPING

⚠ WARNING: Make sure the pistol is unloaded. If not, unload it following the “UNLOADING” instructions in this manual (page 15).

Remove the magazine and ensure the pistol is unloaded by inspecting the barrel's chamber.

Retract the slide and hold it while depressing the striker deactivation button with a small punch or the tip of a ballpoint pen till you hear a click (disengagement of the striker).

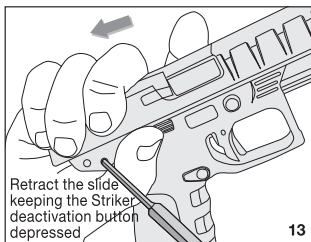

Push and then rotate the take down lever.

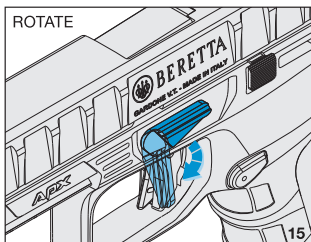
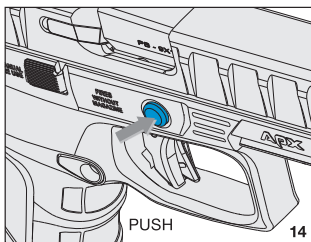

Move the slide forward and remove it from the frame.

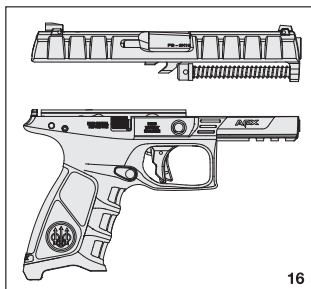

The recoil spring assembly can now be lifted out of the slide. Tilt the barrel by grasping the cam lug and remove the barrel from the slide.

⚠ Notice: No further disassembly is required for routine maintenance.

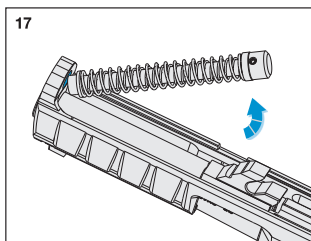

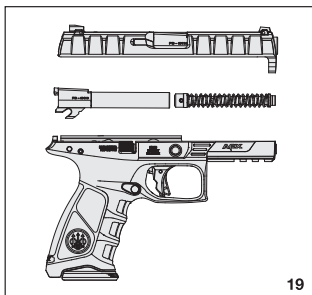
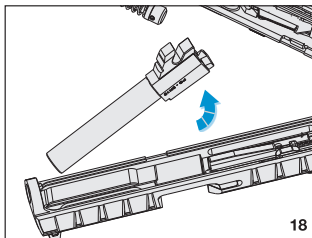

when under spring pressure and the take down lever is not in the “Locked” position, the slide can launch off the frame.

Check that the take down lever is correctly assembled with the lever in the vertical position. With the muzzle pointed in a safe direction, retract the slide and visually confirm that the take down lever has rotated and shifted to the “Locked” position.

BARREL OBSTRUCTIONS CHECK

⚠ WARNING: Catastrophic failure can result if a cartridge is fired into an obstructed barrel.

REASSEMBLY

Reassemble by inserting the barrel into the slide. Tip the barrel to install the muzzle end through the hole in the front of the slide, then lower the rear end into position in the slide.

Install the recoil spring assembly with the large flat end engaged into the recess in the barrel cam lug.

⚠ Notice: If the slide is released

If you believe the barrel might be obstructed follow the “FIELD STRIPPING” operations and disassemble the pistol (page 26).

After disassembly, look down the barrel and check to be sure there are no obstructions in the chamber or bore.

If an obstruction in the barrel is detected, a qualified gunsmith **MUST** remove the obstruction and inspect the pistol to ensure it is safe before it can be fired.

If no obstruction is found, re-assemble the pistol by following the procedures given in the “REASSEMBLY” section of this manual (page 27).

REPLACING THE MAGAZINE RELEASE BUTTON

⚠ WARNING: Make sure the pistol is unloaded. If not, unload it following the “UNLOADING” procedure (page 15).

⚠ CAUTION: Before proceeding with the disassembly of the parts, closely observe and memorize the position of the components to make assembly easier.

⚠ Notice: It is advisable to perform field stripping and assembly operations over a table to catch components should they drop.

⚠ CAUTION: The spring is under tension.

Remove the magazine. Insert a properly sized drift-punch into the hole of the magazine release button mounted on the pistol.

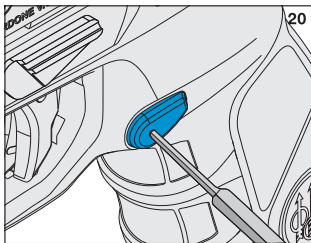

Without using excessive force, firmly push the drift-punch into the hole. This will allow the magazine release button to disengage from the internal pin, which will protrude from the opposite side.

Remove the pin.

Insert a properly sized drift-punch in the hole of the magazine plunger to push out the magazine release button and the magazine release spring from the other side, preventing the magazine release button to jump out under the spring load. Then remove the plunger.

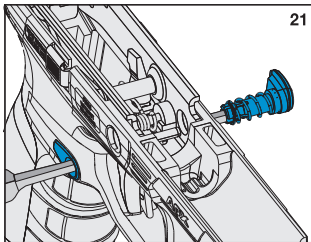

To replace the magazine button, insert the magazine release plunger into the proper cut on one side of the frame, then insert the magazine release spring and the magazine release button into the proper cut on the other side of the frame. Depress the magazine release button to its full travel. Insert the magazine release pin into the magazine release plunger. Firmly push on the head of the magazine release pin so that it will lock the assembly together.

Try to remove the button from its seat to check that it is properly installed. Check the function of the magazine release button using an empty magazine.

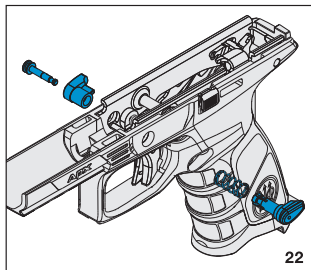

22

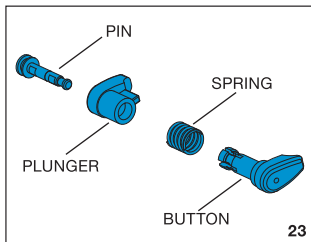

23

REVERSING THE MAGAZINE RELEASE BUTTON

⚠ WARNING: Make sure the pistol is unloaded. If not, unload it following the “UNLOADING” procedure (page 15).

⚠ CAUTION: Before proceeding with the disassembly of the components, closely observe and memorize the location of the components to make assembly easier.

ⓘ Notice: It is advisable to perform disassembly and assembly operations over a table to catch components should they drop.

Remove the magazine. Follow the instructions previously given to remove the magazine release button.

CAUTION: The spring is under tension.

Reassemble the magazine button with its spring on the opposite side of the pistol.

Try to remove the button from its seat to check that it is properly installed. Check the function of magazine release button using an empty magazine.

CHANGING THE BACKSTRAPS

Three different sizes (small, medium and large) of backstraps allow the customization of the Beretta APX grip for the best fit.

To change the backstrap:

WARNING: Make sure the pistol is unloaded. If not, unload it following the “UNLOADING” instructions in this manual (page 15).

Field strip the pistol following the “FIELD STRIPPING” in-

structions in this manual to remove the slide assembly (page 26).

Once the slide is removed, with a small punch push the internal backstrap retainer to the right and then downwards, remove it and slide the backstrap out.

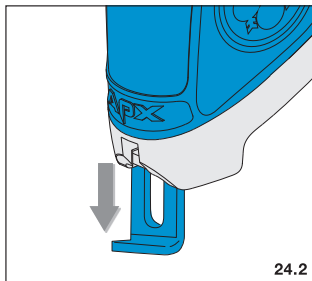
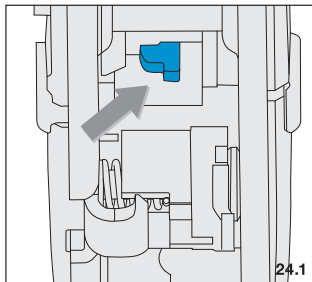

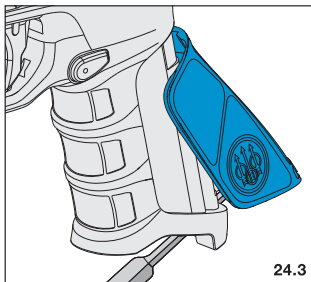

24.3

Select the desired backstrap, put the retainer back in its place making sure the curved part points outward, then push it upwards until it is engaged.

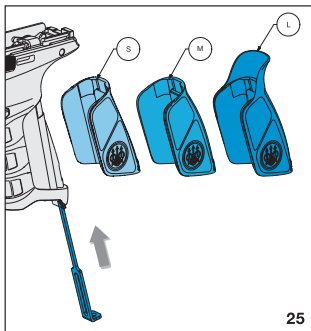

25

chassis that carries the serial number and firing mechanism. The frame can easily be removed for maintenance or to be replaced with an alternate unit.

To remove the frame:

⚠ WARNING: Make sure the pistol is unloaded. If not, unload it following the “UNLOADING” instructions in this manual (page 15).

⚠ CAUTION: Before proceeding with the disassembly of the components, closely observe and memorize the location of the components to make assembly easier.

ⓘ Notice: It is advisable to perform disassembly and assembly operations over a table to catch components should they drop.

Field strip the pistol following the “FIELD STRIPPING” instructions in this manual to remove the slide assembly (page 26).

Rotate the take down lever to a horizontal position and push it out from right to left and place it aside.

FRAME REMOVAL

Beretta APX pistols have a

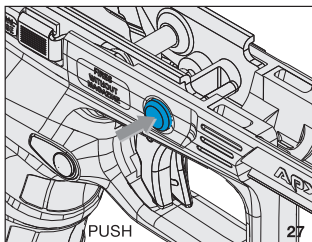
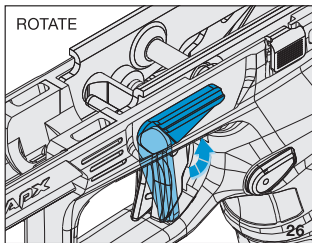

With a small punch, lift the cocking lever spring leg out of the retaining groove in the rear chassis pin. Keeping the leg of the spring lifted and using a second punch, push from right to left the rear chassis pin out of the frame.

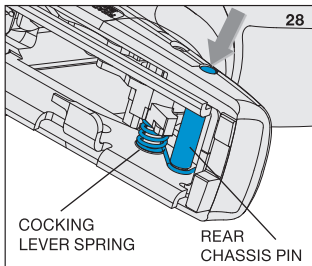

In case of thumb safety configuration, with a pin punch, push out the safety lever retaining pin and remove the right thumb safety. With a small punch, lift the cocking lever spring leg out of the retaining groove in the rear chassis pin. Keeping the leg of the spring lifted and using a second punch, push from right to left the rear chassis pin together with the left thumb safety out of the frame.

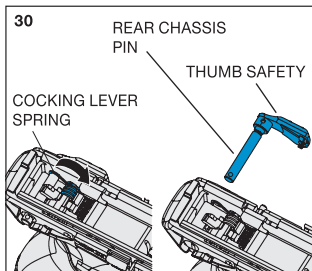
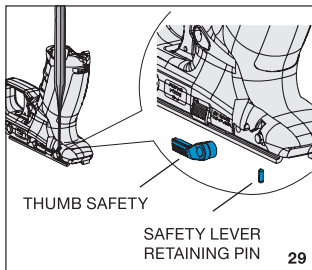

When attempting to lift the chassis out of the frame depress the striker deactivation button with a small punch or the tip of a ballpoint pen. When the tip of the pin clears the inner walls of the frame the chassis will lift out.

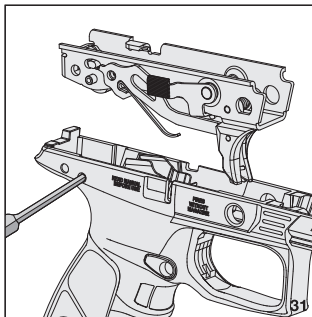

FRAME INSTALLATION

Install the chassis in the frame starting with the front corner and roll the rear of the chassis down until the striker deactivation button contacts the top of the frame.

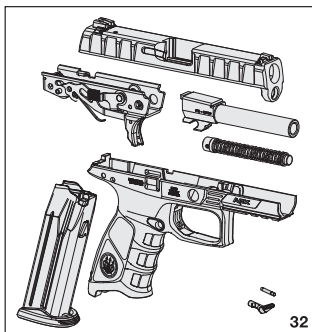
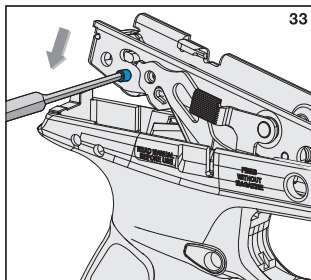

While lightly pressing down on the chassis, depress the striker deactivation button with a punch until the chassis drops into the frame. There will be an audible “snap” when the chassis is seated.

Using the punch, lift the cocking lever spring leg higher than the rear chassis pin hole and push the rear chassis pin in the frame.

Using the punch, lift the cocking lever spring leg higher than the rear chassis pin hole

and push the rear chassis pin partially in the frame (1-2 mm is enough). Push down the cocking lever to allow the rear chassis pin to slide through the holes in the frame.

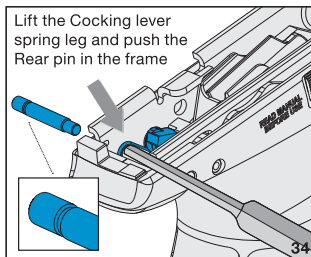

In case of thumb safety configuration, do the same inserting the rear chassis pin together with the left thumb safety into the frame. Install the right thumb safety locking it with the pin.

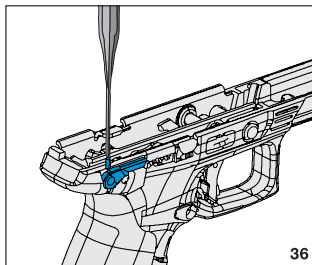
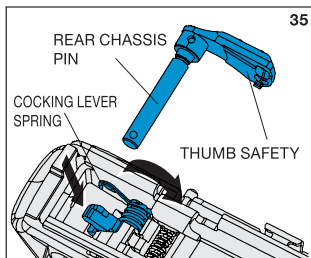

Check that the cocking lever spring leg has engaged the groove of the pin by pushing the pin slightly back and checking for any movement.

Lightly push the take down lever through the frame and chassis from left to right with lever horizontal. Insert it completely, shift it out and rotate the lever to a vertical position.

This completes the frame reassembly.

MAINTENANCE

The firearm should be cleaned as soon as possible after firing. Use only high-quality, commercially available firearm cleaning solvents, gun oil and cleaning equipment.

Field strip the pistol as indicated in the "FIELD STRIPPING"

section of this manual (page 26).

⚠ WARNING: Excess oil and grease obstructing the bore, even partially, is very dangerous when firing and may cause barrel rupture and serious injury to the shooter and bystanders. Never spray or apply oil to the cartridges. Use lubricants properly. You are responsible for the proper care and maintenance of your firearm.

BARREL

Apply gun oil to a bore-cleaning brush. Insert the brush into the barrel from the chamber end and scrub the chamber and bore thoroughly. Make sure you pass the bore brush all the way through the barrel before pulling back through. If necessary, first clean the bore with a gun solvent. Dry the chamber and bore by pushing a cotton patch through the chamber and bore with the brush or cleaning jag. Repeat with a new patch until it emerges clean. Clean the barrel locking lug with a cloth soaked in gun oil. Lightly oil the entire barrel prior to reassembly.

⚠ WARNING: Do not clean

the barrel with the pistol assembled.

ⓘ Notice: Cleaning the barrel from the breech (chamber) end will avoid damaging the muzzle or bore.

SLIDE

Clean the slide with a cloth soaked in gun oil paying particular attention to the breech face, extractor, slide rails, locking shoulders. If necessary, use a NYLON cleaning brush. Dry slide surfaces with a clean cloth and lightly oil the guides of the slide.

ⓘ CAUTION: Do not apply oil on the striker. While oiling the slide prevent oil from entering the striker window. Accumulation of oil attracts dirt and dust, which can interfere with the functioning and reliability of the firearm.

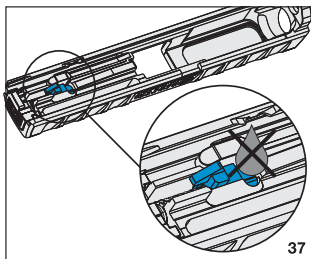

RECOIL SPRING AND SPRING GUIDE ASSEMBLY

Lightly oil the spring guide assembly with gun oil. After extensive use it may be necessary to first clean these parts using a NYLON cleaning brush.

FRAME ASSEMBLY

Using a cloth lightly soaked in gun oil, clean the areas of the cocking lever, the ejector, and the slide rails. If necessary, use a cleaning brush.

Dry the parts and lightly oil the slide rails.

MAGAZINE

Make sure the magazine is thoroughly clean and that the follower slides easily downward if pressed. Dry the internal walls of the magazine box with a cloth. Do not leave any oil in the magazine.

 **CAUTION:** Do not apply excess oil. Accumulation of oil attracts dirt and dust, which can interfere with the functioning and reliability of the firearm.

STORAGE

 **WARNING:** Always

store the pistol **UNLOADED**, with the magazine empty.

 **WARNING:** Always store your firearm so that children can not gain access to it. To reduce the risk of accidents involving children, unload your firearm, lock it and store the ammunition in a separate locked location.

 **CAUTION:** Before storage, always check the conditions of the pistol and its case. Make sure the case is dry and that the firearm is dry and oiled. Traces of moisture or drops of water could damage the pistol.

TROUBLE-SHOOTING

 **WARNING:** Do not attempt to make repairs to any firearm without proper knowledge or training. Do not alter parts or use substitute parts not made by Beretta. Any necessary alterations or adjustments to the operating mechanism should be performed by the Manufacturer or by its Local Official Distributor.

⚠ WARNING: Do not attempt to alter the internal parts of your pistol's firing mechanism. Altering internal parts can cause an unsafe condition.

⚠ WARNING: Altering the internal parts of your pistol's firing mechanism voids the manufacturer's warranty.

MALFUNCTION	PROBABLE CAUSE	REMEDY
Mis-feeding	Defective cartridge Dirty feeding ramp	Inspect ammunition Clean feeding ramp and cartridge chamber
Mis-fire	Defective cartridge Slide out of battery Dirty cartridge chamber	Inspect ammunition Clean feeding ramp and breech face
Failure to extract	Defective cartridge Dirty cartridge chamber Dirty extractor	Inspect ammunition Clean extractor and cartridge chamber
Slide out of battery	Defective cartridge	Inspect ammunition

POS.	DESCRIPTION
1	BARREL CAL. 9x19 MM
1	BARREL CAL. 9x21 IMI
1	BARREL CAL. .40S&W
100	SLIDE ASSEMBLY CAL. 9x19 MM / 9x21 IMI
100	SLIDE ASSEMBLY CAL. .40S&W
2	SLIDE CAL. 9x19 MM
2	SLIDE CAL. .40S&W
3	STRIKER
4	STRIKER RETURN SPRING
5	STRIKER SPRING ASSEMBLY
6	EXTRACTOR PIN
7	EXTRACTOR SPRING
8	EXTRACTOR PLUNGER
9	EXTRACTOR
10	STRIKER BLOCK
11	STRIKER BLOCK SPRING
12	SLIDE COVER PLATE
13	REAR SIGHT, STANDARD
14	RETAINING PIN
17	FRONT SIGHT, STANDARD
18	FRAME ASSEMBLY
18.1	FRAME
18.2	MAGAZINE RELEASE BUTTON
18.3	MAGAZINE RELEASE SPRING
18.4	MAGAZINE RELEASE PLUNGER
18.5	MAGAZINE RELEASE PIN
18.6	BACKSTRAP RETAINER / LAINYARD ATTACHMENT POINT
18.7	MEDIUM BACKSTRAP
19	TRIGGER UNIT
19.1	CHASSIS
19.2	COCKING LEVER
19.3	STRIKER BLOCK LEVER
19.4	COCKING LEVER PIN / STRIKER DEACTIVATION BUTTON
19.5	COCKING LEVER SPRING
19.6	O-RING
19.7	BARREL DISCONNECTOR/SLIDE STOP ASSEMBLY PIN
19.8	SLIDE STOP ASSEMBLY
19.9	TRIGGER PIN
19.10	TRIGGER
19.11	TRIGGER SAFETY
19.12	TRIGGER SAFETY SPRING
19.13	TRIGGER SPRING
19.14	TRIGGER BAR
19.15	TRIGGER BAR SPRING
19.16	TRIGGER BAR PIN
20	TAKE DOWN LEVER
21	REAR CHASSIS PIN
22	RECOIL SPRING ASSEMBLY CAL. 9X19 MM
22	RECOIL SPRING ASSEMBLY CAL. .40S&W
23	MAGAZINE CAL. 9X19 MM
23	MAGAZINE CAL. 9x21 IMI
23	MAGAZINE CAL. .40S&W
S	SMALL BACKSTRAP
L	LARGE BACKSTRAP

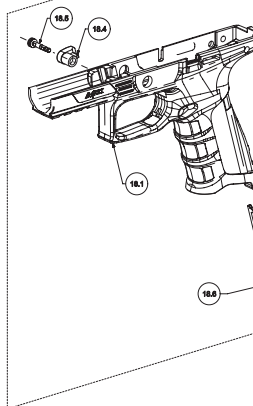
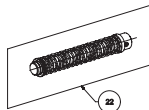
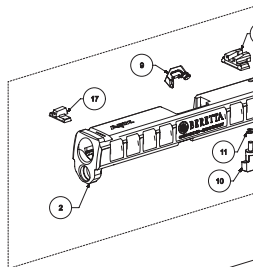

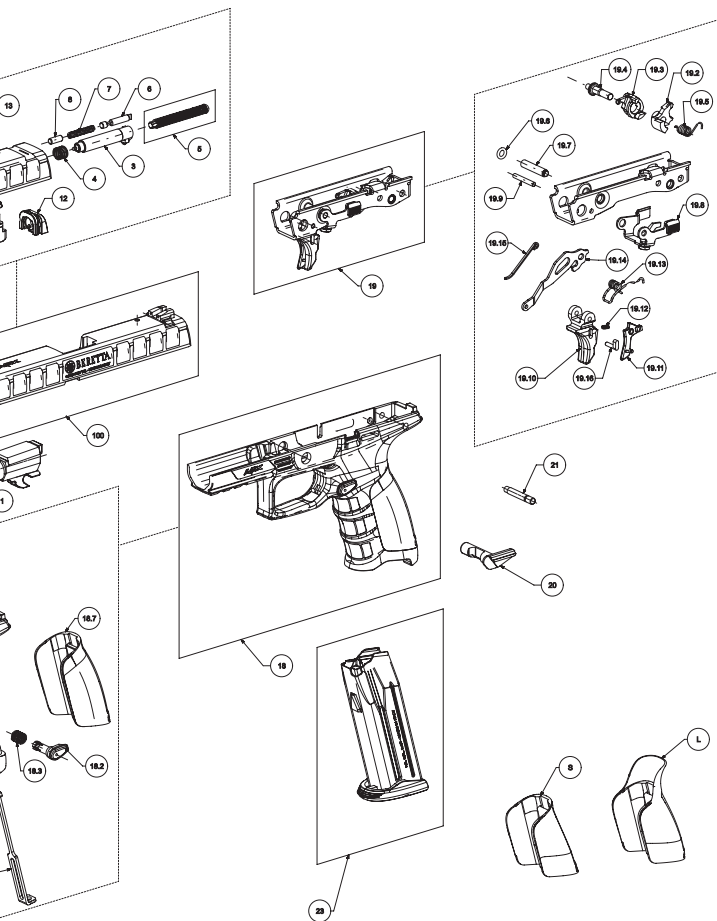

POS.	LONG BARREL	THUMB SAFETY	LOADED CHAMBER INDICATOR	DESCRIPTION
1	●		●	BARREL CAL. 9x19 MM
1	●			BARREL CAL. 9x21 IMI
1	●		●	BARREL CAL. .40S&W
100	●		●	SLIDE ASSEMBLY CAL. 9x19 MM / 9x21 IMI
100	●		●	SLIDE ASSEMBLY CAL. .40S&W
2	●		●	SLIDE CAL. 9x19 MM
2	●		●	SLIDE CAL. .40S&W
14			●	RETAINING PIN
18		●		FRAME ASSEMBLY
18.1		●		FRAME
21		●		REAR CHASSIS PIN
22	●			RECOIL SPRING ASSEMBLY CAL. 9x19 MM
22	●			RECOIL SPRING ASSEMBLY CAL. .40S&W
24		●		THUMB SAFETY, RIGHT
25		●		THUMB SAFETY, LEFT
26		●		SAFETY LEVER RETAINING PIN
27		●		SAFETY PLUNGER
28		●		SAFETY PLUNGER SPRING
29			●	LOADED CHAMBER INDICATOR CAL. 9x19 MM
29			●	LOADED CHAMBER INDICATOR CAL. .40S&W
30			●	LOADED CHAMBER INDICATOR SPRING

LONG BARREL

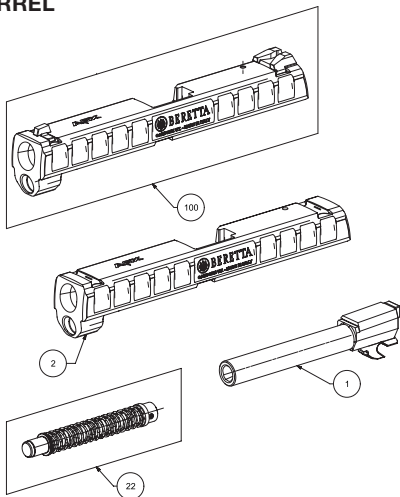

THUMB SAFETY

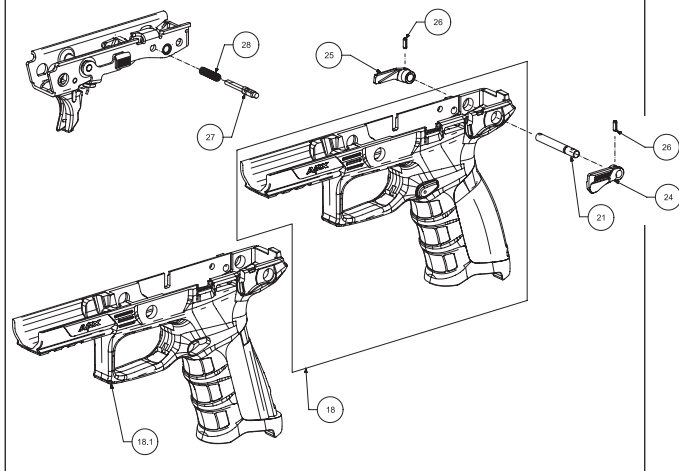

LOADED CHAMBER INDICATOR

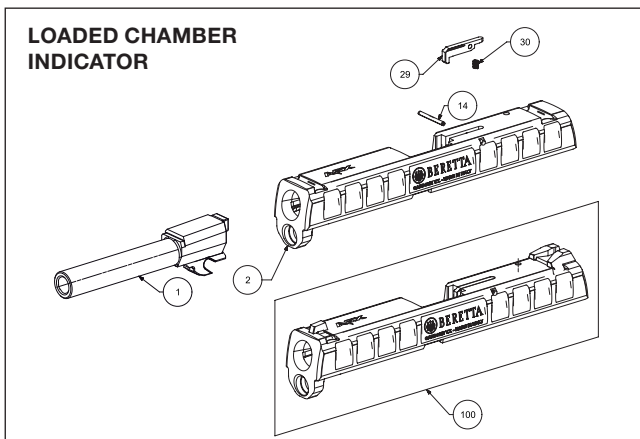

NOTE:

SERIAL NUMBER:

DATE PURCHASED:

PURCHASE PRICE:

DEALER INFORMATION:

The illustrations and descriptions given in this brochure are intended as a general guide only, and must not be taken as binding. The Company, therefore, reserves the right to make, at any moment and without prior notice, any changes it thinks necessary to improve its models or to meet any requirements of manufacturing or commercial nature.