

M&P[®]

by **Smith & Wesson[®]**

Safety & Instruction Manual For M&P[®] 380 SHIELD[™] EZ[®] PISTOLS



M&P[®] 380 SHIELD[™] EZ[®]



Performance Center[®]
Models Included



**Read the instructions and
warnings in this manual
CAREFULLY BEFORE
using this firearm.**

2100 Roosevelt Avenue • Springfield, MA 01104
1-800-331-0852 • Fax: 413-747-3317
www.smith-wesson.com

Copyright © 2020 Smith & Wesson Inc.
All rights reserved.



**WARNING:
READ THESE
INSTRUCTIONS AND
WARNINGS CAREFULLY.
BE SURE YOU UNDERSTAND
THESE INSTRUCTIONS AND
WARNINGS BEFORE USING THIS
FIREARM. FAILURE TO READ THESE
INSTRUCTIONS AND TO FOLLOW
THESE WARNINGS MAY RESULT
IN SERIOUS INJURY OR DEATH TO
YOU AND OTHERS AND
DAMAGE TO PROPERTY.**

**THIS SAFETY & INSTRUCTION
MANUAL SHOULD ALWAYS
ACCOMPANY THIS FIREARM AND BE
TRANSFERRED WITH IT UPON CHANGE
OF OWNERSHIP OR WHEN PRESENTED
TO ANOTHER PERSON. A COPY OF THE
SAFETY & INSTRUCTION MANUAL IS
AVAILABLE FREE VIA DOWNLOAD AT
www.smith-wesson.com
OR UPON REQUEST FROM:**

**SMITH & WESSON®
CUSTOMER SUPPORT CENTER
2100 ROOSEVELT AVENUE
SPRINGFIELD, MA 01104
TEL.: 1-800-331-0852, ext. 4125
E-mail: qa@smith-wesson.com**

TABLE OF CONTENTS

YOUR SAFETY RESPONSIBILITIES	3-6
SAFE STORAGE AND TRANSPORTATION	7-8
AMMUNITION	9-11
MODEL AND FEATURES IDENTIFICATION	12-13
LOADED CHAMBER INDICATOR	14
MANUAL THUMB SAFETY (for models so-equipped)	15
INSPECTING YOUR PISTOL	16-17
PREPARATION FOR FIRING	18
LOADING	19-21
FIRING	22-23
CLEARING MISFIRES	23-24
UNLOADING	25-26
FIELD STRIPPING / DISASSEMBLY	26-29
LUBRICATION	30
FIELD STRIPPING / ASSEMBLY	30-32
MAGAZINE	33-35
REVERSIBLE MAGAZINE RELEASE	36-39
SIGHT ADJUSTMENT	39
CLEANING AND MAINTENANCE.....	40-42
LIMITED WARRANTY	43-44
CONTACT AND SHIPPING INFORMATION	45-46
CUSTOM SERVICE	47
BATTERY WARNINGS.....	49
INT'L WARRANTY CENTERS AND PATENT INFO	50
PORTED BARREL WARNINGS (for models so-equipped)	51

YOUR SAFETY RESPONSIBILITIES

SAFETY IS YOUR NUMBER ONE RESPONSIBILITY!

- At home, in the field, at the range, or anywhere, the first concern of every firearm owner should be safety. Apply the following safety rules in every situation, with any kind of firearm. If you feel uncertain about any operational aspects of your firearm, please contact Smith & Wesson® at 1-800-331-0852, ext. 4125 before proceeding with its operation.
- If you are unfamiliar with firearms you should seek formal training before using your pistol.



WARNING: YOU MUST FOLLOW ALL OF THESE SAFETY RULES TO ENSURE THE SAFE USE OF YOUR FIREARM. THE FAILURE TO FOLLOW THE INSTRUCTIONS AND WARNINGS IN THIS MANUAL COULD CAUSE SERIOUS PERSONAL INJURY OR DEATH TO YOU OR OTHERS AND DAMAGE TO PROPERTY.

- As a firearm owner, you accept a demanding responsibility. How seriously you take this responsibility can be the difference between life and death. There is no excuse for careless or abusive handling of your firearm. At all times handle your firearm with intense respect for its power and potential danger.

YOUR SAFETY RESPONSIBILITIES CONTINUED

- **ALWAYS KEEP YOUR FIREARM POINTED IN A SAFE DIRECTION.** Never point a firearm at anyone or anything you do not intend to shoot whether or not it is loaded. This is particularly important when loading, unloading, or field stripping the gun. ALWAYS control the direction of the firearm.
- **ALWAYS TREAT EVERY FIREARM AS IF IT IS LOADED AND WILL FIRE.** Do not take anyone's word that the firearm is unloaded – always check for yourself. Never pass your firearm to another person until the cylinder or action is open and you visually check that it is unloaded. Keep your firearm unloaded and safely stored when not in use.
- **NEVER PLACE YOUR FINGER INSIDE THE TRIGGER GUARD OR ON THE TRIGGER UNLESS YOU INTEND TO FIRE.** Ensure that other objects do not touch the trigger.
- **ALWAYS BE SURE OF YOUR TARGET AND WHAT IS BEYOND IT.** Always be sure of where the bullet will strike and shoot only where there is a safe back stop free of obstructions, water or other surfaces which can cause ricochets. Be sure your bullet will stop behind your target. Bullets can glance off many surfaces like rocks or the surface of water and travel in unpredictable directions with considerable velocity. Do not fire randomly into the sky.
- **NEVER CROSS OBSTACLES SUCH AS FENCES OR STREAMS WITH A LOADED FIREARM.** Always make certain your firearm is unloaded before crossing a fence, climbing a tree, jumping a ditch or negotiating other obstacles.
- **SAFE GUN HANDLING IS YOUR PERSONAL RESPONSIBILITY AT ALL TIMES.** Firearms are dangerous and can cause serious injury or death if they are misused or used inappropriately. Safety must be the prime consideration of anyone who owns or handles firearms. Accidents are the result of violating the rules of safe gun handling and common sense. Firearm safety training is available. Contact your firearms dealer, law enforcement agency, local sportsman's club, etc. for availability.
- **YOU ARE RESPONSIBLE FOR THE FIREARM AT ALL TIMES.** In owning a firearm, you must undertake full-time responsibility for making sure your firearm is safe and secure at all times. You must protect yourself and all others against injury or death from misuse of the firearm 24 hours a day.
- **FIREARM SECURITY IS YOUR RESPONSIBILITY.** You must secure firearms safely from children and/or unauthorized users. Your firearm should always be kept unloaded and locked when not in use. A lock has been provided for this purpose. Never assume that the use of this lock is sufficient to safely secure your firearm. You must always evaluate your personal situation and employ the security systems that meet your needs and prevent children and unauthorized users from gaining access to your firearm.

YOUR SAFETY RESPONSIBILITIES CONTINUED

- **APPROPRIATE USE OF YOUR FIREARM MEANS USING YOUR FIREARM FOR LEGAL PURPOSES.** For example - target shooting, hunting and lawful resistance of deadly criminal force. It is your responsibility to ensure that you are in compliance with all applicable laws and ordinances regarding the use of your firearm.
- **NEVER RELY ON MECHANICAL FEATURES ALONE.** Only your safe gun-handling habits will ensure the safe use of your firearm. This is your responsibility.
- **ALWAYS SAFELY STORE AND SECURE YOUR FIREARM.** Safe and secure storage of your firearm is one of your most important responsibilities. It is a full-time responsibility. You must always secure your firearm and ammunition separately so that they are not accessible to children and/or other unauthorized persons.
- **NEVER KEEP AMMUNITION IN THE SAME LOCATION AS THE FIREARM.** Store each in a separate and secure place.
- **ALWAYS WEAR EYE PROTECTION THAT IS SPECIFIED FOR USE WITH FIREARMS** every time you handle your firearm for cleaning and maintenance.
- **ALWAYS WEAR EYE AND HEARING PROTECTION THAT ARE SPECIFIED FOR USE WITH FIREARMS** every time you discharge your firearm. Make sure others in the vicinity of where you will be shooting do so as well.
- **NEVER USE ALCOHOL OR DRUGS BEFORE OR WHILE SHOOTING.** Do not use your firearm if you are on any medication which impairs, even slightly, your mental or physical ability.
- **ALWAYS HAVE ADEQUATE VENTILATION.** Discharging firearms in poorly ventilated areas, cleaning firearms, or handling ammunition may result in exposure to lead and other substances known to cause birth defects, reproductive harm, and other serious physical injury. Review the warnings and labels for all ammunition and cleaning products carefully. Wash hands thoroughly after exposure.
- **BEFORE HANDLING ANY FIREARM, UNDERSTAND ITS OPERATION.** Not all firearms are the same. Familiarize yourself with the mechanical features of any firearm you intend to use. If you feel uncertain about any operational aspects of your firearm, please contact Smith & Wesson® at 1-800-331-0852, ext. 4125 before proceeding with its operation.
- **NEVER ALLOW A FIREARM TO BE USED BY INDIVIDUALS WHO DO NOT UNDERSTAND ITS SAFE OPERATION OR HAVE NOT READ THESE FIREARM SAFETY RULES.**

YOUR SAFETY RESPONSIBILITIES CONTINUED

- **ALWAYS USE THE CORRECT AMMUNITION FOR YOUR PARTICULAR FIREARM** as indicated by the marking on the barrel. Never use non-standard, reloaded, or “handloaded” ammunition which has not been subjected to internal ballistic pressure testing.
- **BEWARE OF BARREL OBSTRUCTIONS** Be sure the barrel is clear of obstructions before shooting. Mud, water, snow or other objects may inadvertently lodge in the barrel bore. A small obstruction can cause a dangerous increase in pressure and may damage your gun and cause injury to yourself and others.
- **BE SURE ALL ACCESSORIES, SUCH AS HOLSTERS, GRIPS, SLINGS, SCOPES AND OTHER ACCESSORIES ARE COMPATIBLE** with the firearm and that the accessories do not interfere with safe operation. It is your responsibility to understand and follow all of the instructions in this manual, as well as those which may be supplied with your ammunition and any accessory.
- **NEVER DISASSEMBLE YOUR FIREARM BEYOND THE FIELD STRIPPING PROCEDURE** outlined in this manual. Improper disassembly or reassembly of your firearm may be dangerous and can lead to serious injury or death.
- **NEVER MANIPULATE, ADJUST OR CHANGE ANY OF THE INTERNAL COMPONENTS OF YOUR FIREARM UNLESS SPECIFICALLY INSTRUCTED TO DO SO IN THIS MANUAL.** Improper manipulation of any other internal component may affect the safety and reliability of your firearm and may cause serious injury or death.
- **NEVER ALLOW ANY ALTERATION OR REPLACEMENT OF PARTS IN YOUR SMITH & WESSON® FIREARM UNLESS PERFORMED BY A QUALIFIED GUNSMITH** using genuine Smith & Wesson® parts. If you do otherwise, improper functioning of your firearm may occur and serious injury or death and damage to property may result.



WARNING: SAFE USE OF A FIREARM IS YOUR PERSONAL RESPONSIBILITY AND THE FAILURE TO FOLLOW ALL OF THESE BASIC SAFETY RULES MAY RESULT IN SEVERE PERSONAL INJURY OR DEATH TO YOU OR OTHERS AND DAMAGE TO PROPERTY. YOU ARE THE MOST IMPORTANT SAFETY DEVICE WHEN IT COMES TO THE USE OF YOUR FIREARM AND SMITH & WESSON® WILL NOT BE RESPONSIBLE FOR ANY PERSONAL INJURY, DEATH OR PROPERTY DAMAGE THAT RESULTS FROM: (1) THE CRIMINAL OR NEGLIGENT USE OF THIS FIREARM; (2) A DISREGARD OF THESE SAFETY INSTRUCTIONS AND WARNINGS; (3) IMPROPER OR CARELESS HANDLING OF THIS FIREARM; (4) THE USE OF NON-STANDARD, DEFECTIVE, OR IMPROPER AMMUNITION; (5) OR, IMPROPER OR NEGLIGENT MODIFICATIONS OR REPAIRS TO THE FIREARM.

SAFE STORAGE AND TRANSPORTATION



WARNING: ALWAYS POINT THE MUZZLE IN A SAFE DIRECTION.



WARNING: FIREARMS ARE DANGEROUS WHEN USED AND STORED IMPROPERLY. THEY POSE A RISK OF SERIOUS OR FATAL INJURIES. FIREARMS CAN BE ESPECIALLY DANGEROUS TO CHILDREN WHEN THEY ARE STORED IN AN IRRESPONSIBLE AND UNSAFE MANNER. FOR YOUR SAFETY AND THE SAFETY OF OTHERS, IT IS IMPERATIVE THAT YOU KEEP YOUR FIREARM LOCKED AND UNLOADED IN A SECURE PLACE. THE AMMUNITION SHOULD BE STORED IN A SEPARATE, SECURE LOCATION WHEN IT IS NOT IN USE. SAFE AND SECURE STORAGE OF YOUR FIREARM IS ONE OF THE MOST IMPORTANT RULES OF FIREARM SAFETY. YOUR FAILURE TO FOLLOW THESE RULES MAY RESULT IN SERIOUS INJURY OR DEATH TO YOU OR OTHERS.

- **ALWAYS SECURE YOUR FIREARM IN A MANNER THAT WILL PREVENT UNAUTHORIZED ACCESS.** Whenever your firearm is not in use, keep it unloaded and locked. Your safety and the safety of others requires that you always secure and store your firearm in a manner that will prevent unauthorized access. Never leave a firearm unattended unless it is locked, unloaded and secured.
- **ALWAYS USE THE LOCK PROVIDED BY SMITH & WESSON® TO SECURE YOUR FIREARM.** Please read and follow the instructions packaged separately for the use of this lock. A lock, when properly used, can be an effective tool in preventing unauthorized access to your firearm. There are other alternative locks and safe storage containers available in the marketplace which may also be appropriate for your particular needs. Consult your local gun shop, hardware store, or local police department for guidance on the variety of other safe storage devices or practices which may be appropriate for your particular needs. By purchasing this firearm you have accepted the responsibility of safely securing the firearm at all times and preventing its unauthorized use. Never assume that the use of this lock alone is sufficient to safely secure your firearm. It is your personal responsibility to select and use whatever measures or practices that will enable you to be absolutely certain that your firearm is secure at all times.



WARNING: NEVER LOCK A LOADED FIREARM AND NEVER LOAD A LOCKED FIREARM!

- **ALWAYS STORE YOUR FIREARM AND AMMUNITION SEPARATELY** so that they are not accessible to children or other unauthorized persons. Safe and secure storage of your firearm and ammunition are your responsibility. It is a full-time responsibility.

SAFE STORAGE AND TRANSPORTATION CONTINUED

- **NEVER ASSUME THAT A “HIDING” PLACE IS A SECURE STORAGE METHOD.** Others may be aware of your storage location or come upon it by chance. It is your personal responsibility to use common sense when storing your firearm and ammunition and to always make sure they are not accessible to children or other unauthorized persons.
- **NEVER TRANSPORT A LOADED FIREARM.** When transporting your firearm, be sure it is unloaded and locked. Safe and secure transportation of your firearm is your responsibility.
- **ALWAYS FOLLOW THE LAW!** Many jurisdictions have laws that make it a crime to keep a firearm unlocked and in an area accessible to children or others. Keeping a firearm locked and unloaded when not in use is not only common sense safety practice... **IT IS THE LAW.** You must be familiar with all local, state, and federal laws regarding the safe storage and transportation of your firearm. Failure to know and follow the law may result in unauthorized access or use of your firearm by another. Obey all laws relating to the storage and transportation of firearms. Your local police department or gun shop can furnish you with available information on storing and/or transporting a firearm safely and legally.
- **YOUR FIREARM IS YOUR RESPONSIBILITY.** You must prevent your firearm from being stolen or from being used by untrained or unqualified individuals. Keep it locked, unloaded and secured when not in use.

AMMUNITION



WARNING: NEVER USE AMMUNITION NOT SPECIFICALLY DESIGNATED FOR USE IN YOUR FIREARM. FAILURE TO USE THE CORRECT TYPE OR CALIBER OF AMMUNITION MAY CAUSE THE FIREARM TO JAM, OR FAIL TO FIRE, OR MAY GENERATE EXCESSIVE PRESSURE WHICH CAN DAMAGE OR EVEN RUPTURE YOUR FIREARM, CAUSING PERSONAL INJURY OR DEATH TO THE SHOOTER OR BYSTANDERS.

- Locate the cartridge designation marked on the firearm. This information indicates the correct ammunition that must be used in this firearm (FIGURE 1).
- You are responsible for selecting ammunition that meets industry standards and is appropriate in type and caliber for this firearm.
- Never mix ammunition.



FIGURE 1



WARNING: IN SOME CASES, A ROUND OF AMMUNITION NOT SPECIFIED ON YOUR FIREARM AND NOT LISTED AS ALTERNATE AMMUNITION IN THIS MANUAL, MAY FIT INTO THE CHAMBER. FIRING THIS AMMUNITION MAY CAUSE A RUPTURE RESULTING IN DAMAGE TO THE FIREARM AND PERSONAL INJURY OR DEATH TO THE SHOOTER OR BYSTANDERS. FOR MORE INFORMATION REGARDING UNSAFE CALIBER COMBINATIONS, REFER TO THE FOLLOWING URL: [HTTPS://SAAMI.ORG/TECHNICAL-INFORMATION/UNSAFE-FIREARM-AMMUNITION-COMBINATIONS/](https://saami.org/technical-information/unsafe-firearm-ammunition-combinations/)



WARNING: ALWAYS INSPECT YOUR AMMUNITION BEFORE USING IT. NEVER USE DIRTY, CORRODED OR DAMAGED AMMUNITION. A BURST CARTRIDGE MAY RESULT CAUSING DAMAGE TO THE FIREARM AND PERSONAL INJURY OR DEATH TO THE SHOOTER OR BYSTANDERS.



WARNING: DISCHARGING FIREARMS IN POORLY VENTILATED AREAS, CLEANING FIREARMS, OR HANDLING AMMUNITION MAY RESULT IN EXPOSURE TO LEAD AND OTHER SUBSTANCES KNOWN TO CAUSE BIRTH DEFECTS, REPRODUCTIVE HARM, AND OTHER SERIOUS PHYSICAL INJURY. HAVE ADEQUATE VENTILATION AT ALL TIMES. WASH HANDS THOROUGHLY AFTER EXPOSURE.

- Use only commercially manufactured ammunition with internal ballistic pressures which are in strict accordance with the specifications of the Sporting Arms and Ammunition Manufacturers' Institute (SAAMI). If you are uncertain, contact your ammunition supplier for verification.

AMMUNITION CONTINUED



WARNING: NEVER USE NON-STANDARD, RELOADED OR “HANDLOADED” AMMUNITION WHICH HAS NOT BEEN SUBJECTED TO INTERNAL BALLISTIC PRESSURE TESTING. RELOADED OR HANDLOADED AMMUNITION, MAY HAVE MANY MANUFACTURING AND QUALITY VARIABLES (SUCH AS THE TYPE AND AMOUNT OF GUN POWDER). CARTRIDGE CASES THAT HAVE BEEN RELOADED AND FIRED MULTIPLE TIMES MAY SUFFER PHYSICAL DAMAGE WHICH COULD SIGNIFICANTLY IMPACT OR REDUCE THE INTEGRITY OF THE CARTRIDGE, POSSIBLY RESULTING IN BULLET SET-BACK OR UNSEATING. CASE FAILURE AND INJURY TO THE SHOOTER OR BYSTANDERS AND DAMAGE TO THE FIREARM MAY RESULT WHEN SUCH A ROUND IS FIRED. ANY AMMUNITION THAT IS IMPROPERLY MANUFACTURED OR RELOADED, EVEN IN THE SLIGHTEST DEGREE, MAY FAIL TO FIRE OR MAY GENERATE EXCESSIVE INTERNAL PRESSURES WHICH CAN DAMAGE OR EVEN RUPTURE THE FIREARM, CAUSING PERSONAL INJURY OR DEATH TO THE SHOOTER OR THOSE IN THE IMMEDIATE VICINITY.

- A firearm and ammunition are a system and must work together. There are different types of ammunition for different types of firearms. Your firearm has been designed for ammunition of a specific type and a specific gauge or caliber. It is important to select the proper ammunition for your firearm.
- Different combinations of bullet velocity, bullet weight and firearm weight can have major impact on felt recoil; high felt recoil can be uncomfortable to some shooters.

For example:

- Firearm Weight: lower firearm weight increases felt recoil.
- Bullet Weight: higher bullet weight increases felt recoil.
- Bullet Velocity: higher bullet velocity increases felt recoil.

To acclimate yourself to higher levels of felt recoil, consider the following:

- Use a firm two-hand hold on the grip when firing.
- Always start your shooting experience with the lowest bullet velocity and lowest bullet weight available for your firearm.
- Ask your firearm dealer to suggest the lowest power, lowest velocity, lightest bullet weight for your firearm.



WARNING: NEVER USE AMMUNITION OF THE INCORRECT GAUGE OR CALIBER. USING AMMUNITION OF THE INCORRECT GAUGE OR CALIBER MAY CAUSE DAMAGE TO YOUR FIREARM AND POSSIBLE SERIOUS INJURY TO YOU AND TO OTHERS.

AMMUNITION CONTINUED



WARNING: NEVER USE CARTRIDGES OTHER THAN THOSE DESIGNATED BY THE MARKING ON THE FIREARM. DOING SO CAN RESULT IN DANGEROUSLY HIGH PRESSURES THAT MAY DAMAGE THE FIREARM AND POSSIBLY CAUSE SERIOUS INJURY TO YOURSELF AND OTHERS.



WARNING: DEATH, SERIOUS INJURY AND PROPERTY DAMAGE CAN RESULT FROM THE USE OF INCORRECT AMMUNITION OR BORE OBSTRUCTIONS. NEVER USE RELOADED AMMUNITION THAT HAS NOT BEEN SUBJECTED TO INTERNAL BALLISTIC PRESSURE TESTING. SEE PAGE 10 FOR DETAILS.

- “Plus-P” (+P) ammunition generates pressures in excess of the pressures associated with standard ammunition. Such pressures may affect the wear characteristics and may result in the need for more frequent service.
- “Plus-P-Plus” (+P+) ammunition must not be used in Smith & Wesson firearms. This marking on the ammunition designates that it exceeds established industry standards, but the designation does not represent defined pressure limits and therefore such ammunition may vary significantly as to the pressures generated and could be DANGEROUS.

Marking on Firearm	Ammunition Type		
	Standard	+P	+P+
380 AUTO	OK	NO	NO
9mm Luger	OK	OK	NO
9x21mm	OK	NO	NO
38 Super	OK	OK	NO
357 SIG	OK	NO	NO
40 S&W	OK	NO	NO
45 AUTO	OK	OK	NO

- Some brands of ammunition may cause difficulty in extracting spent cartridge cases from the chamber. If this situation occurs, thoroughly clean the chamber with solvent. If this condition persists, we recommend changing to another brand of ammunition.

MODEL AND FEATURES IDENTIFICATION

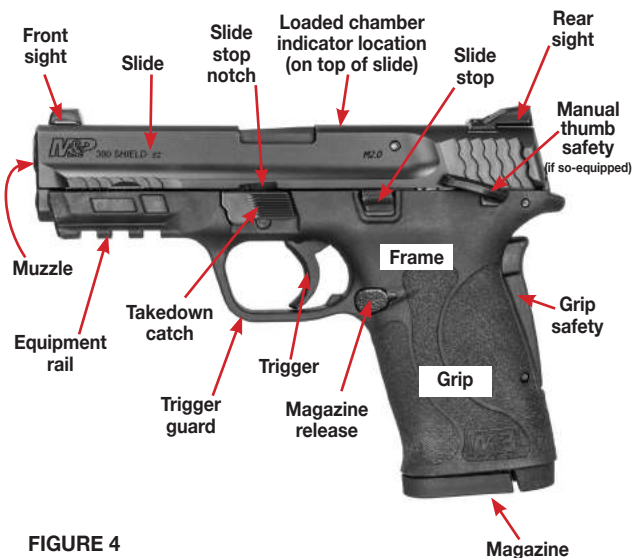

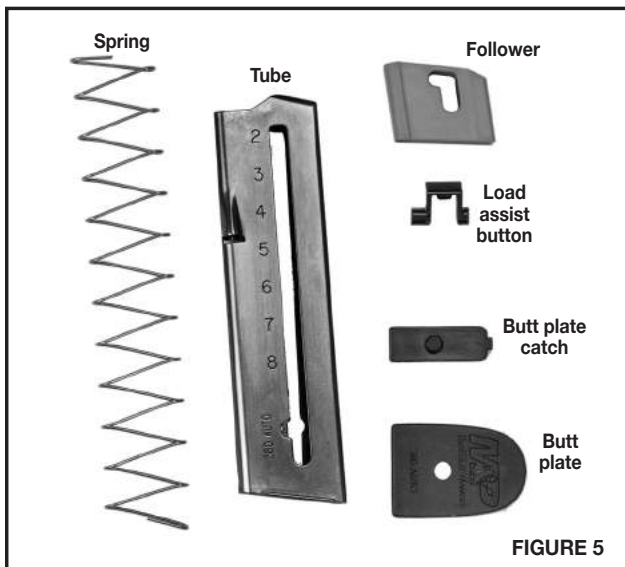

WARNING: YOU MUST DETERMINE WHICH FEATURES ARE PRESENT ON YOUR SPECIFIC SMITH & WESSON® PISTOL AND HOW THOSE FEATURES OPERATE. VARIOUS MODELS OF THE PISTOL ARE FITTED WITH DISTINCT FEATURES, WHICH MAY INCLUDE: ONE OF TWO LOADED CHAMBER INDICATORS, A PORTED BARREL AND SLIDE AND A MAGAZINE SAFETY. SEE THE SECTION(S) OF THIS MANUAL THAT DETAIL EACH OF THESE FEATURES.

LOADED CHAMBER INDICATOR



WARNING: NEVER RELY UPON THE TACTILE LOADED CHAMBER INDICATOR ALONE TO VERIFY THE PRESENCE OR ABSENCE OF A ROUND IN THE CHAMBER.

THE SUREST METHOD TO DETERMINE THE PRESENCE OR ABSENCE OF A ROUND IN THE CHAMBER IS TO VISUALLY CHECK THE CHAMBER OF YOUR FIREARM BY REMOVING THE MAGAZINE AND PULLING AND LOCKING THE SLIDE IN THE OPEN POSITION.

- The M&P® 380 SHIELD™ EZ® pistols come with a tactile loaded chamber indicator. This indicator can be observed by looking at the top of the slide (FIGURE 6), noting a lever that may be raised above the flat surface.

- If this lever is visible and can be felt above the surface of the slide, a round is in the firearm's chamber.

- If no round is in the chamber, you will not be able to feel and see the lever raised above the flat surface of the slide top (FIGURE 7).

Tactile loaded chamber indicator is up when a round is in the chamber, providing visual and tactile feedback



Tactile loaded chamber indicator flush with top of slide when no round is present in chamber



WARNING: ALWAYS TREAT EVERY FIREARM

AS IF IT IS LOADED AND WILL FIRE IF THE TRIGGER IS PULLED. A LOADED CHAMBER INDICATOR MAY HELP DETERMINE WHETHER THE CHAMBER IS LOADED OR UNLOADED.

MANUAL THUMB SAFETY LEVER

For Those Models So-Equipped

- Your M&P® 380 SHIELD™ EZ® pistol may be equipped with a manual thumb safety lever.



WARNING: NEVER RELY ON MECHANICAL FEATURES ALONE. ONLY YOUR SAFE GUN HANDLING WILL ENSURE THE SAFE USE OF YOUR FIREARM. THIS IS YOUR RESPONSIBILITY.



WARNING: IT IS YOUR RESPONSIBILITY TO CONTINUOUSLY EXAMINE YOUR PERSONAL SITUATION TO PROVIDE A SUFFICIENT LEVEL OF SAFETY.

- This feature prevents the pistol from firing when the manual thumb safety lever is fully up in the SAFE position (FIGURE 8).



- Push the thumb safety lever fully down to put it in the “FIRE” position (FIGURE 9). This will allow the pistol to be fired when the grip safety is then firmly depressed by gripping with the firing hand and pulling the trigger rearward.



- The magazine can be removed and installed in the pistol regardless of the position of the safety lever.
- The slide can be manipulated to load (or unload) the chamber regardless of the position of the manual thumb safety lever.

- The slide can also be removed from the frame and reinstalled onto the frame regardless of the position of the manual thumb safety lever.

- The trigger of the M&P® 380 SHIELD™ EZ® with a manual thumb safety can still be depressed (without firing the pistol) when the manual thumb safety lever is in the SAFE position.

- Keep your finger away from the trigger unless you are in the act of firing.

INSPECTING YOUR PISTOL



WARNING: ALWAYS ENSURE THAT THE FIREARM IS UNLOADED BEFORE INSPECTING, DISASSEMBLING, ASSEMBLING OR CLEANING AND ALWAYS KEEP THE MUZZLE POINTED IN A SAFE DIRECTION.

- When you inspect your pistol, you should first check for yourself to ensure that it is unloaded. Never take anyone's word for it.

- As shipped from the factory, an empty chamber flag is used to indicate that no round of ammunition is present in the chamber (FIGURE 10).

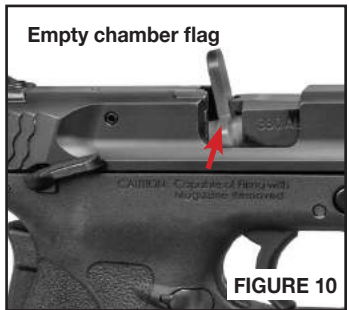

- Grasp the pistol with your finger off the trigger and outside the trigger guard, point the muzzle in a safe direction, depress the magazine release and remove the magazine from the pistol (FIGURE 11).



- Grasp the serrated sides of the slide from the rear with the thumb and fingers as shown (FIGURE 12) and briskly draw the slide fully rearward in order to extract any cartridge from the barrel chamber and clear it from the pistol. Do not obstruct the ejection port because doing so can interfere with complete ejection of a cartridge from the pistol.

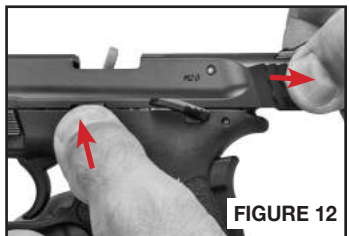

- With the slide still held fully open, lock the slide in the open position by allowing the slide to move slightly forward from the rearmost position while pressing upward on the slide stop (FIGURE 12).

- Remove the empty chamber flag from the pistol (FIGURE 13).



- Before using your firearm for the first time, it should be cleaned.

INSPECTING YOUR PISTOL CONTINUED

- Check the barrel and magazine area visually for any ammunition (FIGURES 14 and 15).

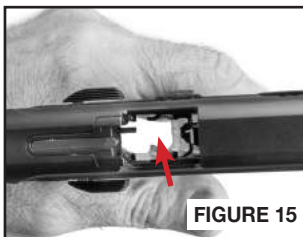

- Check the barrel visually for any bore obstructions. Remove any obstructions that are found.
- Examine the breech face (FIGURE 16) to ensure that the firing pin is not protruding from the breech face (FIGURE 17). If the firing pin is protruding (FIGURE 18), do not attempt to load or fire the firearm. Bring the firearm to a gunsmith qualified to perform service on Smith & Wesson® firearms.

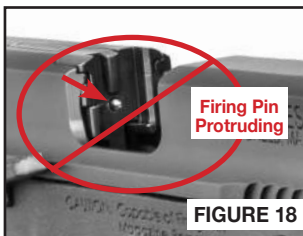

- You must follow this procedure every time a firearm leaves your hand, is cleaned, handed to you or another person, transported or stored.



WARNING: NEVER RELY ON MECHANICAL FEATURES ALONE. ONLY YOUR SAFE GUN HANDLING WILL ENSURE THE SAFE USE OF YOUR FIREARM. THIS IS YOUR RESPONSIBILITY.

PREPARATION FOR FIRING



WARNING: THE FAILURE TO FOLLOW THESE FIREARM SAFETY REQUIREMENTS WILL CAUSE SERIOUS PERSONAL INJURY OR DEATH TO YOU OR OTHERS.

- **ALWAYS TREAT ALL FIREARMS AS IF THEY ARE LOADED.**
- **ALWAYS BE SURE THAT THE CHAMBER IS CLEAR OF A CARTRIDGE, THE MAGAZINE IS REMOVED OR UNLOADED, AND THAT THE FIREARM IS POINTING IN A SAFE DIRECTION.**
- **ALWAYS KEEP FINGERS AND OTHER PARTS OF YOUR BODY AWAY FROM THE MUZZLE AND AWAY FROM THE PISTOL SLIDE AND EJECTION PORT.**
- **ALWAYS WEAR ADEQUATE AND PROPER HEARING PROTECTION SPECIFIED FOR FIREARM USE** to prevent permanent damage to your hearing. Make sure others who are nearby are wearing hearing protection as well.
- **ALWAYS WEAR SAFETY GLASSES SPECIFIED FOR FIREARM USE**, whether indoors or out. Safety glasses should protect your eyes from the firing flash and particles associated with the discharge of ammunition. Failure to do so creates a risk of personal injury from particle or debris spitting or a ricochet.
- **ALWAYS BE ALERT AND ALWAYS FOLLOW THE SAFETY INSTRUCTIONS OF THE RANGE OFFICER.** Never shoot if you are tired, cold or impaired in any way.
- **ALWAYS BE AWARE OF OTHER PEOPLE** so that persons do not accidentally walk into the line of fire.
- **THE SHOOTER (AND ALL OTHERS IN THE SHOOTING AREA) MUST ALWAYS BE IN A POSITION THAT IS OUT OF THE LINE OF FIRE** and are not within an area where they may be struck by a ricochet or particles spitting from a firearm, or by ejected cases from some types of firearms.
- **NEVER SHOOT AT SURFACES THAT MAY CAUSE A RICOCHET.** Always select a place to shoot that has a safe backstop, is free from obstructions and has no surfaces which may cause a ricochet.
- **NEVER FIRE RANDOMLY INTO THE SKY.** Always select a place to shoot that has a safe backstop.
- **NEVER USE ALCOHOL OR DRUGS BEFORE OR WHILE SHOOTING OR HANDLING ANY FIREARM.**

LOADING



WARNING: ALWAYS KEEP THE MUZZLE POINTED IN A SAFE DIRECTION.



WARNING: M&P® 380 SHIELD™ EZ® PISTOLS WILL FIRE WITH THE MAGAZINE REMOVED. KEEP YOUR FINGER OFF THE TRIGGER AND OUTSIDE OF THE TRIGGER GUARD UNTIL YOU HAVE MADE THE COMMITMENT TO FIRE.

- Do not load the pistol until you have read and fully understand this entire manual.
- Do not load the pistol until you are ready to use it. Keep your finger off the trigger and outside the trigger guard until you are ready to fire.
- Never load your pistol until you are sure of your target, what is beyond it and are fully prepared to fire.
- If the magazine is removed with a round left in the chamber, be sure to holster or otherwise safely secure the pistol under your direct control while the magazine is being reloaded.
- Smith & Wesson® has provided you with a magazine designed to operate in your specific model of pistol. While your magazine may be able to be inserted into another model pistol, it will only function properly in the specific model for which it was designed. Do not interchange magazines from one model pistol to another model pistol.
- Follow instructions in this manual and any other specific instructions which may be marked onto, or accompany, a magazine. Failure to use the particular type of Smith & Wesson® magazine specified for your model and caliber of pistol may result in a malfunction.

- Load the magazine by pulling down on the load assist button enough to insert one cartridge at a time (FIGURES 19 and 20).

- Pull the load assist button down just far enough to load one round at a time - as this helps maintain a consistent (orderly) stack within the magazine. If you pull the load assist button down too far and drop the cartridges in, they may tip at the wrong angle.

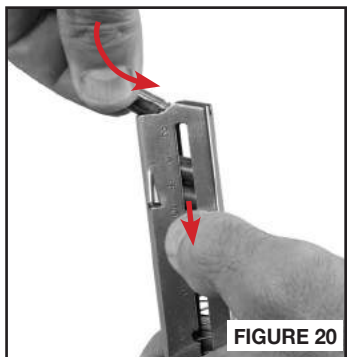
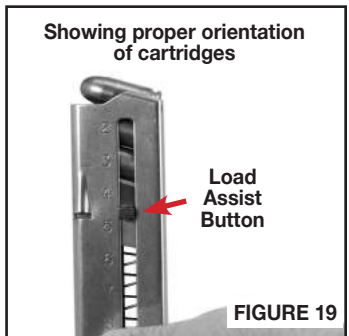

LOADING CONTINUED

- Press the cartridge head (rear of cartridge) downward slightly and slide the cartridge fully under the feed lips of the magazine until the cartridge is fully against the rear wall of the magazine (FIGURE 21).
- Repeat the procedure for the number of cartridges you wish to load, up to the magazine capacity - which is marked on the magazine tube. Do not attempt to load your magazine with more than the specified number of cartridges because doing so can cause a feeding failure.
- Inspect your pistol as previously described in the “Inspecting Your Pistol” section. Hold the pistol in one hand with the muzzle pointing in a safe direction and with your finger off the trigger and outside the trigger guard.

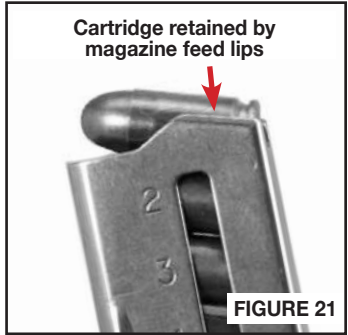

- With the slide locked open, insert the loaded magazine into the magazine well (opening) of the pistol until it is locked in place (FIGURE 22).



WARNING: VERIFY THAT THE FIRING PIN IS NOT PROTRUDING FROM THE BREECH FACE.



WARNING: DO NOT USE EXCESSIVE UPWARD FORCE WHEN INSERTING A LOADED MAGAZINE INTO THE PISTOL. EXCESSIVE UPWARD FORCE COULD CAUSE THE SLIDE TO MOVE FORWARD, CHAMBERING A ROUND AND MAKING THE PISTOL READY TO FIRE.

NOTE: After inserting a magazine, always test to make sure it is locked in place by applying some removal pressure to the exposed portion of the magazine butt plate.

- Pull the slide to the rear and then release it, allowing it to carry fully forward. This strips a cartridge from the magazine and seats it in the chamber of the barrel.

LOADING CONTINUED



WARNING: IF THE CARTRIDGE FAILS TO STRIP FROM THE MAGAZINE OR FULLY SEAT INTO THE CHAMBER, IMMEDIATELY STOP THE LOADING PROCESS. REMOVE THE MAGAZINE, LOCK THE SLIDE OPEN AND VERIFY THAT THE CHAMBER IS EMPTY. REFER TO THE “INSPECTING YOUR PISTOL” SECTION OF THIS MANUAL.



WARNING: ALWAYS LOAD A ROUND INTO THE CHAMBER BY FEEDING IT FROM THE MAGAZINE. FAILURE TO FOLLOW THIS WARNING CAN RESULT IN SEVERE INJURY OR DEATH TO YOU OR OTHERS. NEVER ATTEMPT TO LOAD THE PISTOL BY INSERTING A ROUND INTO THE OPEN EJECTION PORT.

CAUTION: The pistol can now be fired by holding the grip firmly to depress the grip safety and pulling the trigger to the rear.

- If you wish to restore the magazine in your pistol to its full capacity, put the safety lever (if your pistol is so-equipped) fully upward in the SAFE position.
- Depress the magazine release and remove the magazine from the pistol. Remember that there is a round in the chamber; therefore, the pistol should be holstered or safely secured during this process without touching the trigger. Load one cartridge into the magazine to replace the one which was chambered when you allowed the slide to chamber a round.
- Re-insert the loaded magazine into the magazine well of the pistol until it is locked in place. To make sure that the magazine is again fully and securely inserted, apply some removal pressure to the exposed portion of the magazine butt plate.
- Your pistol and its magazine are now fully loaded and the pistol will fire when the grip is held firmly to depress the grip safety and the trigger is pulled to the rear. The manual thumb safety lever (if your M&P® 380 SHIELD™ EZ® pistol is so-equipped) must be in the lowered “FIRE” position to allow the trigger to fire the pistol. Keep your pistol pointed in a safe direction under all conditions and always keep your finger or any other object off the trigger and outside the trigger guard until you have made the commitment to fire.
- Never leave a loaded firearm out of your direct control.

FIRING



WARNING: ALWAYS KEEP THE MUZZLE POINTED IN A SAFE DIRECTION.



WARNING: UPON FIRING THE PISTOL OR RELEASING THE SLIDE FROM THE SLIDE STOP, THE SLIDE MOVES REARWARD OR FORWARD WITH SIGNIFICANT FORCE AND SPEED. TO AVOID INJURY, BE SURE NO PART OF YOUR BODY IS IN THE PATH OF THE SLIDE'S TRAVEL.



WARNING: WEAR EYE AND HEARING PROTECTION SPECIFIED FOR FIREARM USE EVERY TIME YOU DISCHARGE YOUR FIREARM. MAKE SURE OTHERS IN THE VICINITY OF WHERE YOU WILL BE SHOOTING DO SO AS WELL.



WARNING: "STAGING" THE TRIGGER VIOLATES A BASIC RULE OF FIREARM SAFETY WHICH WARNS YOU TO KEEP YOUR FINGER OUT OF THE TRIGGER GUARD UNTIL YOU HAVE MADE THE COMMITMENT TO FIRE. "STAGING" CREATES A SERIOUS RISK OF PERSONAL INJURY OR DEATH SINCE IT MAY LEAD TO AN UNINTENTIONAL DISCHARGE.



WARNING: DO NOT USE ANY ACCESSORY OR GRIP ADD-ON THAT INTERFERES WITH THE GRIP SAFETY FUNCTION.

- It has come to our attention that some users of Smith & Wesson® handguns may “stage” the trigger in anticipation of firing a shot. Staging is the act of pulling the trigger rearward – stopping just short of – the point where the handgun fires. Such manipulation of the trigger can reduce the user’s control of the handgun and can result in an unintentional discharge. Furthermore if the user decides not to fire, release of the trigger from a position close to the firing point in the staging process could result in an unintentional discharge.
- To fire the pistol, the shooter must fully depress the grip safety while holding the pistol. FIGURE 23 shows what the grip safety looks like when it is fully depressed. The proper firing hold is shown in FIGURE 24.



FIRING CONTINUED

- To ensure proper firing control and to fully depress the grip safety, grip the pistol firmly with the shooting hand as shown (FIGURE 24).

The pistol must be gripped firmly to disengage the grip safety



FIGURE 24

- Keep the muzzle pointed in a safe direction and your finger outside the trigger guard until you are ready to fire. While holding the grip firmly, pull the trigger fully to the rear. As the trigger is drawn fully to the rear, the firing assembly is cycled, striking the cartridge primer and firing the cartridge.

Don't allow anything to interfere with slide movement when firing



FIGURE 25

- Upon firing, the slide moves rearward with significant force (FIGURE 25), extracting and ejecting the spent cartridge case. The slide then returns forward under spring pressure, feeding the next cartridge from the magazine into the barrel chamber.

- After firing a shot, you must allow the trigger to move fully forward before you can fire another shot.
- This sequence can be repeated until the last round has been fired, at which time the magazine follower exerts upward pressure on the slide stop causing it to engage the slide and to hold the slide in the “open” position.

CLEARING MISFIRES



WARNING: IF YOUR SMITH & WESSON® PISTOL GIVES ANY INDICATION THAT IT IS NOT PERFORMING PROPERLY OR THE OPERATION OF YOUR HANDGUN HAS CHANGED “THE WAY IT FEELS OR SOUNDS”, STOP FIRING. MAKE SURE THE FIREARM IS POINTED IN A SAFE DIRECTION, UNLOAD THE FIREARM AND HAVE IT INSPECTED AND TEST-FIRED BY A GUNSMITH QUALIFIED TO PERFORM SERVICE ON SMITH & WESSON® FIREARMS.

CLEARING MISFIRES CONTINUED

- If a cartridge fails to fire, the chamber must be manually cleared.
- If your pistol is equipped with a manual thumb safety, place the manual safety lever up in the SAFE position (FIGURE 26).
- Wait at least thirty seconds while keeping the muzzle pointed in a safe direction.
- Keep your finger off the trigger and out of the trigger guard.



- Press the magazine release and remove the magazine from the pistol (FIGURE 27).
- Grasp the serrated sides of the slide from the rear and briskly pull the slide fully rearward to eject the mis-fired round. Do not obstruct the ejection port, and do not attempt to catch the round by placing your hand over the ejection port (FIGURE 28).

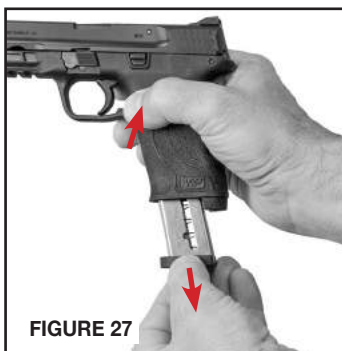

WARNING: M&P® 380 SHIELD™ EZ® PISTOLS ARE DESIGNED TO BE ABLE TO FIRE WHEN THE MAGAZINE IS REMOVED. THEREFORE, IF THE MAGAZINE IS REMOVED FROM THE PISTOL AND THERE IS A LOADED ROUND IN THE CHAMBER, IT WILL FIRE IF THE GRIP SAFETY IS DEPRESSED AND THE TRIGGER IS PULLED.



- Lock the slide in the open position by allowing the slide to move slightly forward from the rearmost position while pressing upward on the slide stop (FIGURE 29).



- You are now able to safely check the barrel chamber and bore for any obstructions. Remove any obstruction that is found.

UNLOADING



WARNING: ALWAYS KEEP YOUR PISTOL POINTED IN A SAFE DIRECTION. ALWAYS KEEP YOUR FINGER OFF THE TRIGGER AND OUTSIDE THE TRIGGER GUARD WHEN UNLOADING.

- If your pistol is equipped with a manual thumb safety, place the manual thumb safety lever up in the SAFE position (FIGURE 30).

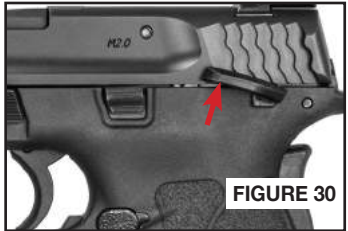

FIGURE 30

- Depress the magazine release and remove the magazine (FIGURE 31).

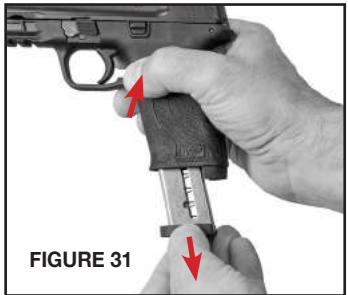

FIGURE 31

- With the muzzle pointed in a safe direction, and your finger off the trigger and outside the trigger guard, grasp the serrated sides of the slide from the rear with the thumb and fingers (FIGURE 32) and briskly draw the slide fully rearward in order to extract any cartridge from the chamber and clear it from the pistol.

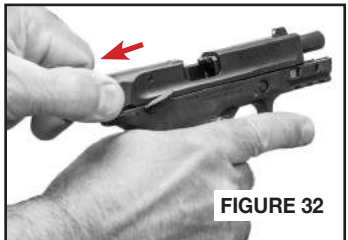

FIGURE 32

- Lock the slide open by allowing the slide to move slightly forward from the rearmost position while pressing upward on the slide stop (FIGURE 33). Do not obstruct the ejection port because doing so can interfere with ejection of a cartridge. Visually check the chamber to be sure it is empty (FIGURE 34A).

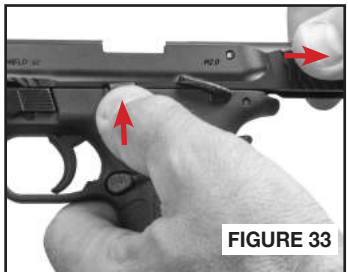

FIGURE 33

- Look into the chamber and down through the magazine well. Verify that no ammunition remains in the pistol (FIGURE 34B).



FIGURE 34A

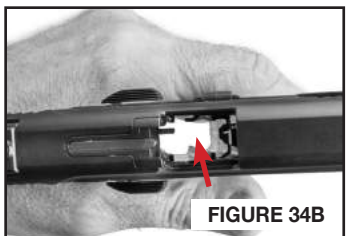
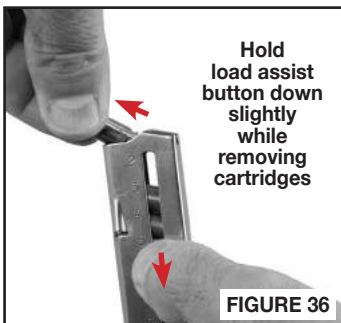
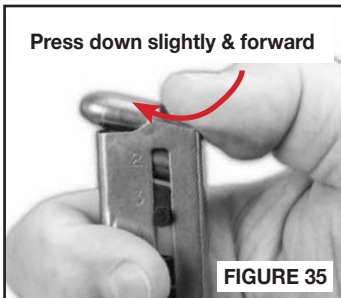

FIGURE 34B

UNLOADING CONTINUED

- Unload the magazine by holding it with the bullet end of the cartridge pointing away from you and pressing each cartridge down at the rear and forward, out of the magazine as shown (FIGURE 35).

NOTE: It may be helpful to pull down on the load assist button a little bit to take the tension off each cartridge as you remove them (up and forward) from the magazine (FIGURE 36).



FIELD STRIPPING/DISASSEMBLY



WARNING: ALWAYS KEEP YOUR PISTOL POINTED IN A SAFE DIRECTION. ALWAYS KEEP YOUR FINGER OFF THE TRIGGER AND OUTSIDE THE TRIGGER GUARD WHEN DISASSEMBLING.



WARNING: ALWAYS FOLLOW THE FIELD STRIPPING INSTRUCTIONS EXACTLY. NEVER DO ANYTHING BEYOND WHAT YOU ARE SPECIFICALLY INSTRUCTED TO DO IN THIS MANUAL. NEVER ALTER OR MODIFY THE PARTS IN YOUR PISTOL.



WARNING: WEAR SAFETY GLASSES EVERY TIME YOU ASSEMBLE OR DISASSEMBLE YOUR FIREARM.

- If your pistol is equipped with a manual thumb safety, place the manual thumb safety lever up in the SAFE position (FIGURE 37).



FIELD STRIPPING / DISASSEMBLY CONTINUED

- Depress the magazine release and remove the magazine (FIGURE 38).
- With the muzzle pointing in a safe direction, and with your finger off the trigger and outside the trigger guard, grasp the serrated sides of the slide from the rear with the thumb and fingers (FIGURE 39) while holding the firearm in an upright position, and briskly draw the slide fully rearward in order to extract any cartridge from the barrel chamber and clear it from the pistol.
- Lock the slide open by holding it fully rearward and pressing up on the slide stop lever (FIGURE 40).
- Make certain that the pistol is clear of any ammunition (FIGURES 41 and 42).



WARNING: DO NOT ALTER, MODIFY OR

REPLACE ANY OF THE PARTS OF YOUR FIREARM UNLESS THIS WORK IS PERFORMED BY A QUALIFIED GUNSMITH USING GENUINE SMITH & WESSON PARTS. IF YOU DO OTHERWISE, IMPROPER FUNCTIONING MAY OCCUR AND SERIOUS INJURY MAY RESULT.

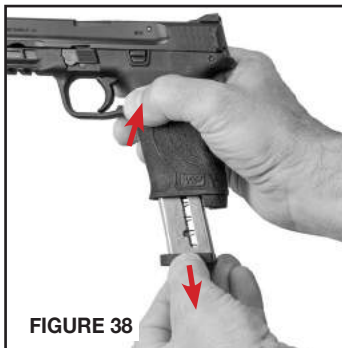

FIGURE 38



FIGURE 39

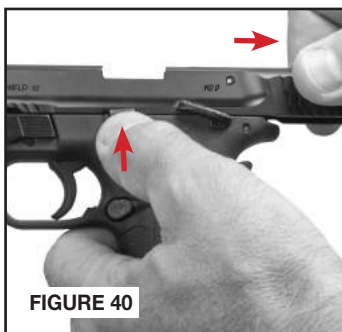

FIGURE 40

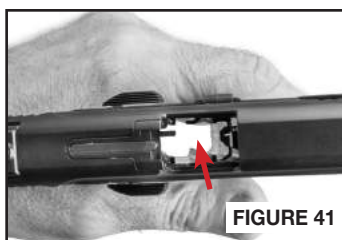

FIGURE 41



FIGURE 42

FIELD STRIPPING / DISASSEMBLY CONTINUED

- Rotate the takedown lever down to the 6 o'clock position (FIGURE 43).



- Close the slide by grasping the serrated sides and drawing it rearward (FIGURE 44), until the slide stop disengages, then carefully allow the slide to move forward to its closed position.



- Remove the slide from the frame by pushing it forward with your thumb (FIGURE 45).



- Retain control of the recoil spring when the slide is removed from the frame (FIGURE 46).

WARNING: THE RECOIL SPRING IS UNDER PRESSURE. CONTROL THE SPRING SO THAT IT DOES NOT FLY OUT AND CAUSE INJURY.

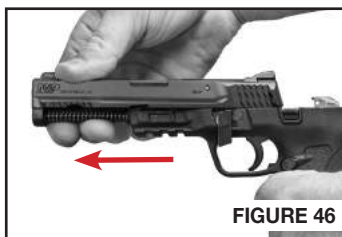

- FIGURE 47 shows the recoil spring assembly in relation to the barrel lug and slide.

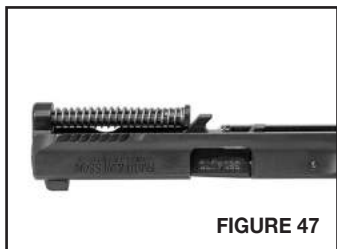

FIELD STRIPPING / DISASSEMBLY CONTINUED

- Remove the recoil spring assembly from the barrel lug and slide by compressing the spring slightly and lifting it out (FIGURE 48).



- Remove the barrel from the slide by grasping the barrel by the lug and lifting up and back (FIGURE 49).

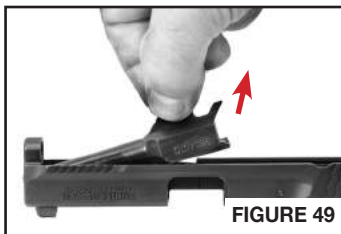

- FIGURE 50 shows the pistol field stripped for cleaning.



 **WARNING: NEVER DISASSEMBLE YOUR HANDGUN BEYOND THE FIELD STRIPPING PROCESS OUTLINED IN THIS MANUAL. NEVER MANIPULATE ANY INTERNAL COMPONENTS BEYOND WHAT YOU ARE SPECIFICALLY INSTRUCTED TO DO IN THIS MANUAL SINCE THIS MAY AFFECT THE RELIABILITY, FUNCTIONING AND SAFETY OF YOUR HANDGUN.**

 **WARNING: DO NOT DRY FIRE YOUR M&P® 380 SHIELD™ EZ® PISTOL WHILE THE SLIDE IS REMOVED. DOING SO CAN RESULT IN DAMAGE TO THE HAMMER OR OTHER INTERNAL PARTS.**

LUBRICATION

- There are several lubrication points (FIGURES 51 and 52) where a single drop of high-quality firearms lubricant should be applied. This will ensure proper lubrication. Care should be taken not to over-lubricate. Excess lubricant can collect large quantities of unburned powder and carbon residue, which could interfere with proper functioning of the pistol.

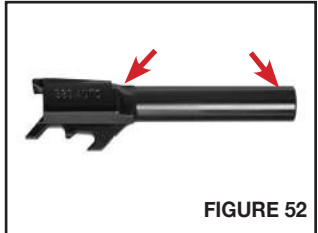
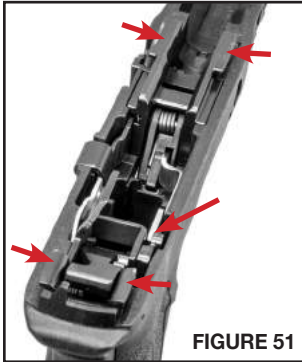

ASSEMBLY



WARNING: ALWAYS FOLLOW THE FIELD STRIPPING INSTRUCTIONS EXACTLY. NEVER DO ANYTHING BEYOND WHAT YOU ARE SPECIFICALLY INSTRUCTED TO DO IN THIS MANUAL. NEVER ALTER OR MODIFY THE PARTS IN YOUR PISTOL.



WARNING: WEAR SAFETY GLASSES EVERY TIME YOU ASSEMBLE OR DISASSEMBLE YOUR FIREARM.

- Replace the barrel into the slide as shown (FIGURE 53). Start the muzzle of the barrel into the hole at the front of the slide and then tip the rear of the barrel down into position.

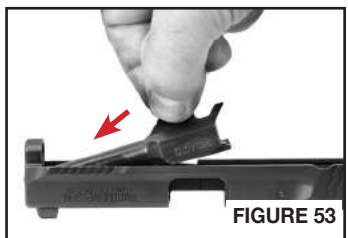

NOTE: The recoil spring assembly is “keyed” to be oriented in a specific manner. When installing the recoil spring assembly, align the front of the shaft with the opening in the front of the slide as shown (FIGURE 54).

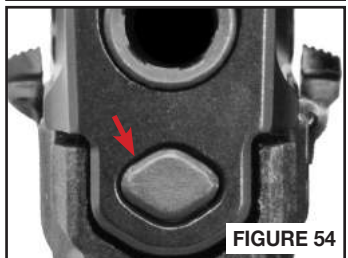

ASSEMBLY CONTINUED

- Reinstall the recoil spring/guide rod assembly to its position with the rear of the assembly bearing against the barrel lug in the notch (FIGURE 55).



- Make sure that the recoil spring/guide rod is properly centered and is clipped into the notch on the barrel lug (FIGURES 56 and 57).



NOTE: To facilitate installing the slide assembly onto the frame, make sure the hammer is in the “cocked” position. If the hammer is visible above the frame (FIGURE 58), push it down and back until it is cocked as shown (FIGURE 59).

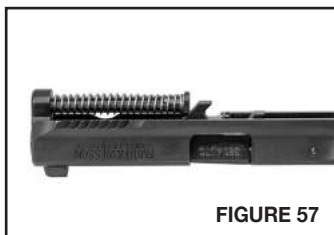

NOTE: Do not depress the grip safety (FIGURE 60) as this causes the firing pin plunger lever to interfere with the slide as it is installed. Keeping tension off of the grip safety allows the firing pin plunger lever to remain below the frame when installing the slide (FIGURE 61).



ASSEMBLY CONTINUED

- While retaining the recoil spring in position, push the slide assembly onto the frame rails (FIGURE 62).
- Continue to push the slide back and onto frame rails (FIGURE 63).
- Pull the slide fully rearward and lock it open by pressing up on the slide stop lever (FIGURE 64).
- Once the slide is fully rearward and locked open, rotate the takedown lever 90 degrees counter-clockwise (FIGURES 65 and 66).

NOTE: If the takedown lever binds and doesn't lock into a horizontal position, rotate the lever back down and re-seat the slide again to align the components. After locking the slide to the rear again, rotate the takedown lever to the position shown.

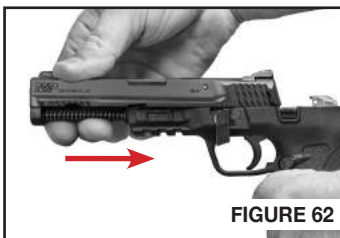

- Close the slide by grasping the serrated sides and drawing it rearward (FIGURE 67), until the slide stop disengages, then allow the slide to move forward to its closed position.



MAGAZINE



WARNING: WEAR SAFETY GLASSES EVERY TIME YOU ASSEMBLE OR DISASSEMBLE YOUR MAGAZINE.



WARNING: THE MAGAZINE SPRING IS UNDER PRESSURE. CONTROL THE SPRING AND FOLLOWER SO THAT THEY DO NOT FLY OUT AND CAUSE INJURY.

- FIGURE 68 shows the component parts that make up the magazine.

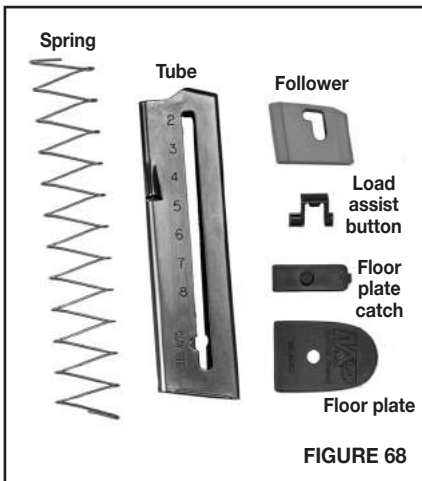

MAGAZINE DISASSEMBLY

- Using a small tool like the hex wrench that comes in the box with the pistol, depress butt plate catch through the hole in the butt plate (FIGURE 69). Slide the butt plate forward a little bit while holding the catch down.
- Once the catch is unlocked, slide the butt plate off of the tube slowly while controlling the butt plate catch in the tube against spring pressure (FIGURES 70 and 71).
- Remove butt plate catch and spring out through bottom of the tube.

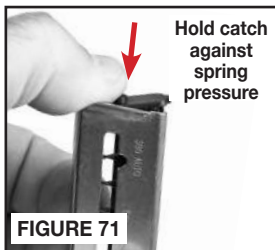
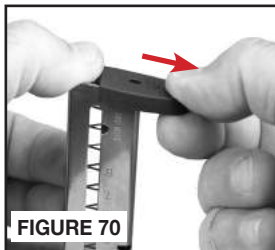
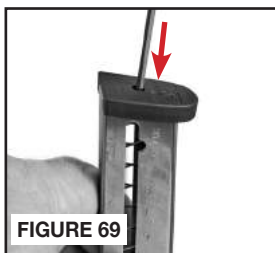

MAGAZINE CONTINUED

- Slide the follower and load assist button down to the bottom of the tube where the wider hole (FIGURE 72) will allow the load assist button to be removed from the side of the magazine tube where the hole matches that shape of the load assist button (FIGURE 73).
- The follower can then be removed from the bottom of the magazine tube.
- FIGURE 74 shows the magazine disassembled for cleaning.

MAGAZINE ASSEMBLY

- Install the follower into the magazine tube from the bottom.
- Insert the load assist button from the side of the magazine tube and slide into the follower. The hole in the follower should line up with the shaped hole in the tube.
- Insert the magazine spring and butt plate catch into the tube from bottom of magazine tube in the same orientation as they were in when they were removed during disassembly (FIGURE 74).

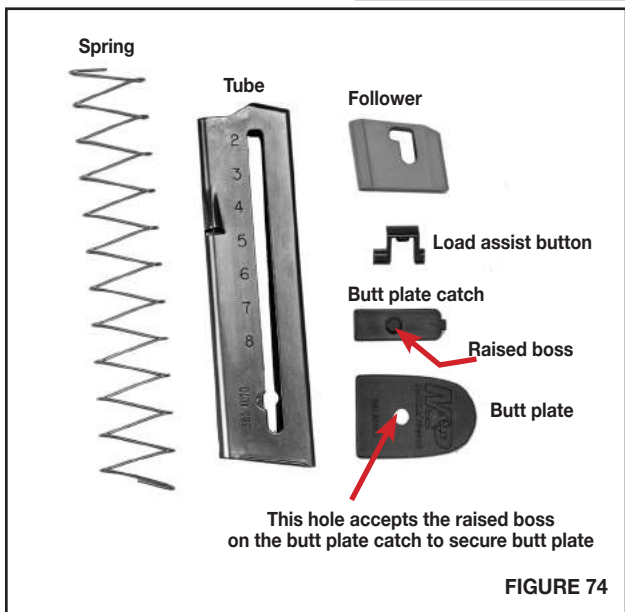
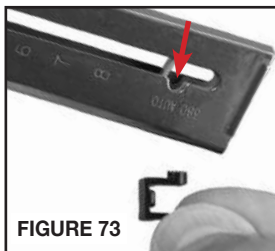
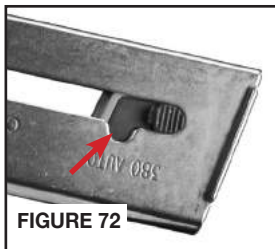

MAGAZINE CONTINUED

- The magazine spring is reversible (top to bottom) but when installing it into the magazine tube, keep the “uphill” slant toward the front of the magazine as shown (FIGURE 75).

NOTE: With the raised boss of the butt plate catch (FIGURE 76) toward the bottom of the magazine, align the tab at the front of the butt plate catch with the cutout in the front of the magazine tube (FIGURE 77) when reassembling. If the butt plate catch is not aligned this way, the raised boss on the magazine catch won't engage the hole in the butt plate and lock in.

- While holding butt plate catch in the tube, slide the butt plate onto the tube flanges until the raised boss on the butt plate catch engages the hole in the butt plate. An audible “click” will generally indicate that the parts are locked in place.

- The longer side of the Load Assist Button goes on the left side - as viewed from the rear of the magazine (FIGURES 78 and 79).

- Check that the butt plate is “locked” in place by applying a tug to the butt plate.

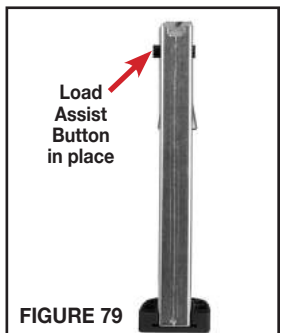
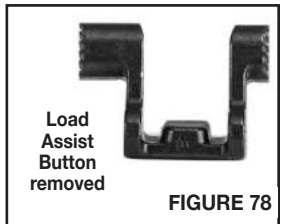
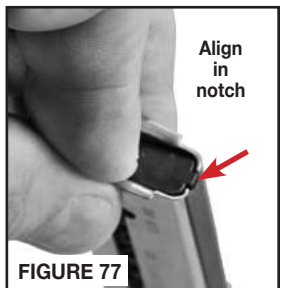
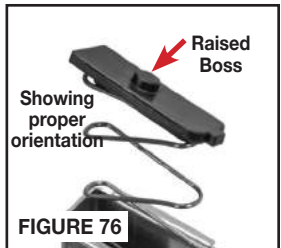
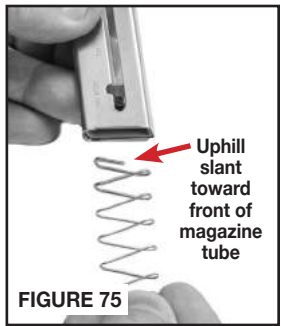

REVERSIBLE MAGAZINE RELEASE

NOTE: Read through this entire section before attempting to reverse your magazine release to help understand what needs to be done. After reading all the instructions, then proceed from the beginning.

- The magazine release can be installed to operate from the right or left side. To reverse the magazine release, follow these instructions:



WARNING: ENSURE THAT YOUR FIREARM IS UNLOADED BEFORE BEGINNING TO DISASSEMBLE IT.



WARNING: WEAR SAFETY GLASSES EVERY TIME YOU DISASSEMBLE OR ASSEMBLE YOUR FIREARM AND ATTEMPT CLEANING, MAINTENANCE OR ADJUSTMENT.

- Field strip the pistol as detailed earlier in this manual.
- The spring rod that retains the magazine release is located inside the magazine well toward the front (see FIGURES 80 and 83).
- FIGURE 81 shows the magazine release removed from the pistol for clarity.
- The textured side of the magazine release is the surface you push on to free the magazine from the pistol.
- From the top of the frame, carefully pry the spring rod out of its retaining notch as shown (FIGURES 83 & 84).
- When installing the magazine release, the textured side should be on the side of the pistol that you want to push on (to release the magazine from the pistol) (FIGURE 82).

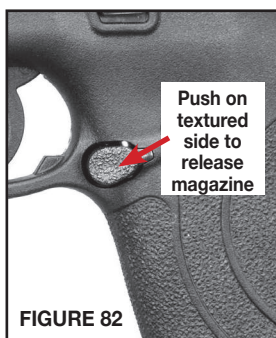
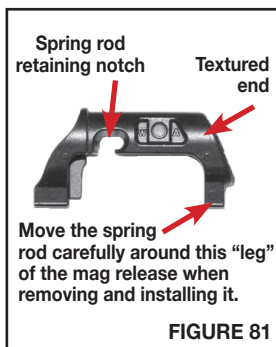
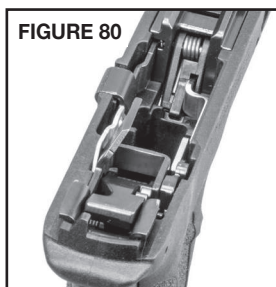

LOOKING DOWN INTO MAGAZINE WELL

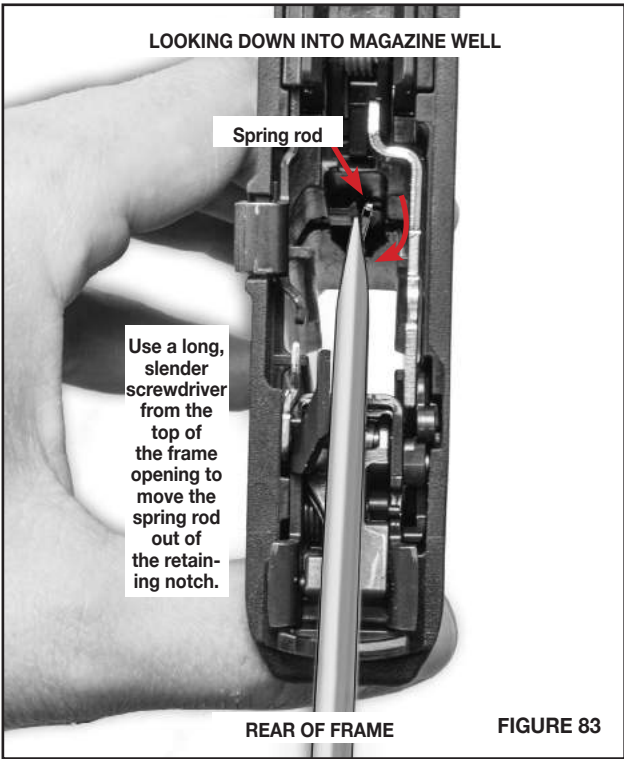

Spring rod

Use a long, slender screwdriver from the top of the frame opening to move the spring rod out of the retaining notch.

REAR OF FRAME

FIGURE 83

LOOKING DOWN INTO MAGAZINE WELL

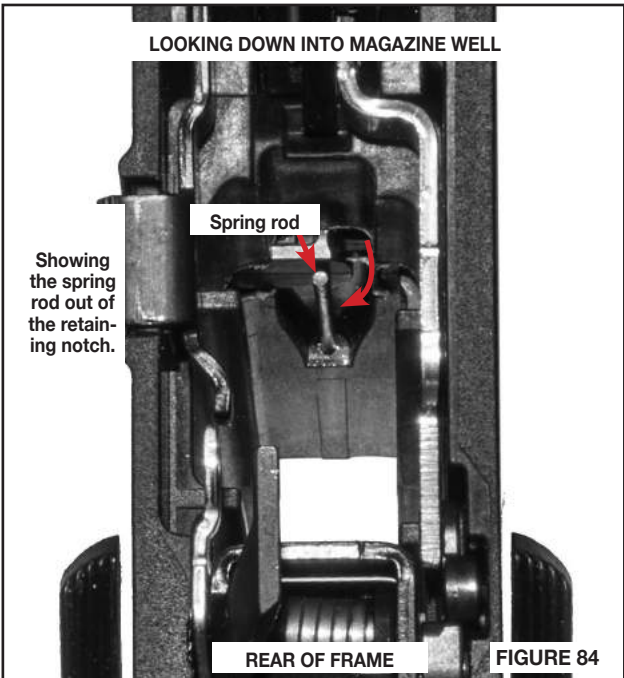

Spring rod

Showing the spring rod out of the retaining notch.

REAR OF FRAME

FIGURE 84

REVERSIBLE MAGAZINE RELEASE CONTINUED

- Your Smith & Wesson® pistol may be equipped with a magazine • When pulling the magazine release out of the frame, pull it out partially and then rotate it 90 degrees (FIGURE 85) to make it easier to get the spring rod around the “leg” of the magazine release.
- FIGURE 86 shows the spring rod from the side with the magazine release removed from the frame.
- Insert the magazine release from the side you want and rotate the magazine release 90 degrees after partially inserting it into the frame.
- Using a small screwdriver blade, carefully pry the spring rod from the opposite side of the frame around the “leg” of the magazine release when re-installing it.

NOTE: Be careful to not bend the magazine spring rod excessively - as damage may result.

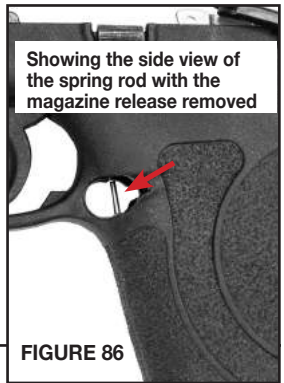

REVERSIBLE MAGAZINE

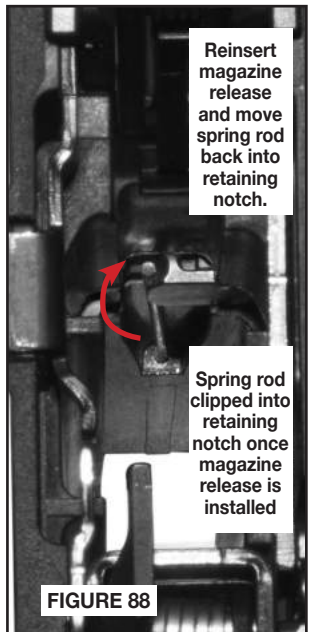
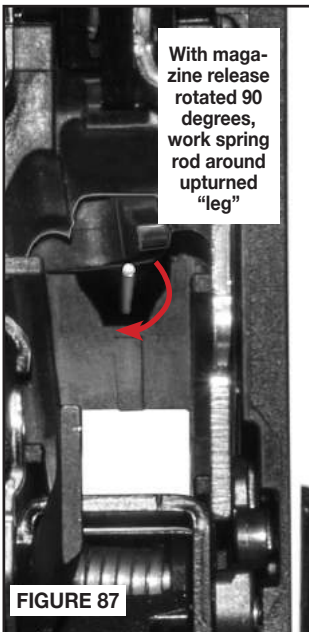

RELEASE CONTINUED

- Push the magazine release into the frame while working the spring rod into the retaining notch (FIGURES 87 and 88).
- Once the magazine release is installed, insert an unloaded magazine into the pistol and check the magazine release for proper function.

SIGHT ADJUSTMENT



WARNING: ENSURE THAT YOUR PISTOL AND MAGAZINE ARE COMPLETELY UNLOADED BEFORE ATTEMPTING TO ADJUST THE REAR SIGHT.

- The rear sight (FIGURE 89) is adjustable for windage only. Windage is the side to side adjustment of where your bullet hits in relation to where you are aiming. To adjust, move the rear sight in the direction you wish the group to move on the target. For example, if the group should move to the right, move the rear sight to the right.
- The rear sight is secured in position with a screw that uses a 3/32" hex wrench (FIGURE 90). A hex wrench is included in the box from the factory.
- To gain access to the rear sight lock screw, the slide must be locked open. Ensure that the pistol and magazine are completely unloaded. It is best to leave the empty magazine in place to help keep the slide from closing during this procedure.
- Loosen the screw slightly (FIGURE 91) to allow the rear sight to be moved in the desired direction, then tighten the screw in the new position.

FIGURE 89

Move rear sight right to make bullet strikes move right on target



Move rear sight left to make bullet strikes move left on target

FIGURE 90

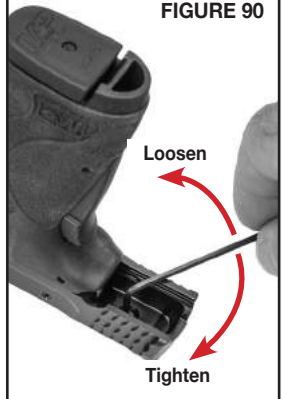

Rear sight lock screw

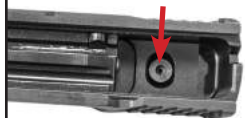

FIGURE 91

CLEANING AND MAINTENANCE



WARNING: ENSURE THAT YOUR FIREARM IS UN-LOADED BEFORE BEGINNING TO CLEAN IT. (SEE “INSPECTING YOUR FIREARM” SECTION). ALWAYS FOLLOW THE RULES OF SAFE GUN HANDLING.



WARNING: WEAR SAFETY GLASSES EVERY TIME YOU ASSEMBLE OR DISASSEMBLE YOUR FIREARM AND ATTEMPT CLEANING OR MAINTENANCE.

- Before using your firearm for the first time, it should be cleaned.
- Your firearm was treated at the factory with either a preservative or oil to protect it against corrosion during shipping and storage.
- Preservative and oil should be wiped from the bore, chamber and exposed areas using a clean swab or patch before using the firearm.

CAUTION: Never disassemble your firearm beyond the instructions in the Field Stripping and Inspection sections of this manual.

- Purchase cleaning supplies from your firearms dealer that are specifically designated for your type and caliber of firearm. Many suppliers offer these in kit form for your convenience.
- Follow the instructions provided with your cleaning supplies.

NOTE: A basic firearm cleaning kit should include: a brass bore brush and a cleaning jag of appropriate size for the bore being cleaned, high-quality gun cleaning solvent and gun oil/lubricant, cotton cleaning patches and a cleaning rod that is long enough to push the brush and jag completely through the barrel.

- Remove excessive firing residue from the bore and chamber using a properly fitted brass brush dipped in gun cleaning solvent. Finish the bore cleaning process by running a dry cotton cloth patch through the bore and chamber to remove residue and solvent.
- Clean the exterior of the firearm using a non-abrasive cleaning cloth.
- After cleaning, lightly coat the metal parts, internal and external with a high quality gun oil.
- Whenever your firearm has been exposed to sand, dust, extreme humidity, water or other adverse conditions, it must be cleaned and lubricated.

CLEANING AND MAINTENANCE CONTINUED



WARNING: ALWAYS HAVE ADEQUATE VENTILATION. CLEANING FIREARMS IN POORLY VENTILATED AREAS, DISCHARGING FIREARMS, OR HANDLING AMMUNITION MAY RESULT IN EXPOSURE TO LEAD AND OTHER SUBSTANCES KNOWN TO CAUSE BIRTH DEFECTS, REPRODUCTIVE HARM, AND OTHER SERIOUS PHYSICAL INJURY. WASH HANDS THOROUGHLY AFTER EXPOSURE.

CAUTION: Always follow the instructions provided with your gun cleaner and gun lubricant.

CAUTION: Some cleaners can cause damage to your firearms. You should avoid prolonged solvent immersion and prolonged ultrasonic cleaning of your firearm. Choice of solvent should be restricted to those products specifically developed for firearms maintenance. Damage to a firearm's finish may occur if these cautions are ignored. Ammoniated solvents or other strong alkaline solvents, should not be used on any Smith & Wesson firearm.

- Cleaning is essential to ensure the proper functioning of your firearm.
- Your firearm is a precision instrument. To ensure reliable function it is necessary to follow a routine maintenance procedure. After firing your firearm, be sure to unload it following the procedure outlined in the section entitled "Inspecting Your Firearm" before performing any cleaning or maintenance procedure.
- Remove any gun cleaning solution, oil and fingerprints from the outside surfaces of the firearm. (Finger moisture, if left, could start a corrosion process).



WARNING: NEVER MANIPULATE, ADJUST OR CHANGE ANY OF THE INTERNAL COMPONENTS OF YOUR FIREARM UNLESS SPECIFICALLY DIRECTED TO DO SO IN THIS MANUAL. IMPROPER MANIPULATION OF ANY INTERNAL COMPONENT MAY AFFECT THE SAFETY AND RELIABILITY OF YOUR FIREARM AND MAY CAUSE SERIOUS INJURY OR DEATH.



WARNING: ANY MAINTENANCE OR SERVICE NOT SPECIFIED IN THIS MANUAL MUST BE PERFORMED BY A QUALIFIED GUNSMITH USING GENUINE SMITH & WESSON PARTS. IF YOU DO OTHERWISE, IMPROPER FUNCTIONING OF YOUR FIREARM MAY OCCUR AND SERIOUS INJURY OR DEATH MAY RESULT.

- If your firearm will be used in a cold climate, be sure to use an oil of an appropriate weight so that it will not congeal in cold temperatures, causing the interaction of important parts to be slowed or halted.

CLEANING AND MAINTENANCE CONTINUED

MAINTENANCE BEFORE STORAGE

- When storing, do not encase your firearm in anything that will attract or hold moisture, for example, leather or heavy cloth. Also, do not store guns with a plug inserted in the barrel for this can be a contributing factor to moisture accumulation. If your firearm is to be stored for an extended period, the bore, chambers and internal working mechanism should be oiled with a high quality lubricating oil or preservative intended for firearms. The external working mechanisms and barrel should be coated with an anti-rust oil. Before using your firearm again, be sure to clean it. Every time you clean your firearm, check it for signs of wear. If excessive wear is noted, do not use the firearm. Return it to Smith & Wesson® for service or have it checked by a qualified gunsmith.

LIMITED WARRANTY

For Owners Within The United States.

This warranty is granted by Smith & Wesson Inc. This warranty is effective from the date of purchase and applies to the original owner of any firearm. With respect to such firearms, this warranty supersedes any and all other warranties.

Smith & Wesson firearms are warranted to be free from defects in material and workmanship. Any such defects of which Smith & Wesson receives written notice within one year from the date of purchase by the original owner, will be remedied by Smith & Wesson without charge within a reasonable time after such notification and delivery of the firearm as provided below.

In the event of an emergency (repairs needed by law enforcement, an upcoming match or hunting trip), call 1-800-331-0852, ext. 4125 and ask for 911 Priority Repair Service. This allows you to speak with a Smith & Wesson representative. Immediately upon receipt, your firearm will be assigned to a gunsmith. After the work is completed, we will return your Smith & Wesson firearm via overnight delivery.

To submit a warranty claim please see the "Contact and Shipping Information" below for details. In addition to the requested information, please include a copy of the bill of sale in the owner's name, or a copy of the ATF Form 4473 indicating date of purchase. It is always important that the owner comply with all applicable federal, state and local laws and regulations.

Warranty claims should state the model and serial number of the firearm concerned and the description of the difficulty experienced. It is recommended that shipments be insured by the owner, since Smith & Wesson will accept no responsibility for loss or damage in transit. Transportation and insurance charges for return to owner will be paid by Smith & Wesson if the claim is covered by the warranty.

UNDER NO CIRCUMSTANCES SHALL SMITH & WESSON BE RESPONSIBLE FOR INCIDENTAL OR CONSEQUENTIAL DAMAGES WITH RESPECT TO ECONOMIC LOSS, INJURY, DEATH OR PROPERTY DAMAGE, WHETHER AS A RESULT OF BREACH OF THIS WARRANTY, NEGLIGENCE OR OTHERWISE.

Some states do not allow the exclusion or limitation of incidental or consequential damages, so the above limitation or exclusion may not apply to you.

Smith & Wesson will not be responsible for:

- Defects or malfunctions resulting from careless handling, unauthorized adjustments or modifications made or attempted by anyone other than a qualified gunsmith following Smith & Wesson authorized procedures, or failure to follow the disassembly instructions in the Smith & Wesson manual.

LIMITED WARRANTY CONTINUED

- Use of defective or improper ammunition, corrosion, neglect, abuse, ordinary wear and tear, or unreasonable use.
- Criminal misuse, negligence or use under the influence of drugs or alcohol.

Smith & Wesson's Lifetime Service Policy begins after the warranty period has expired. Smith & Wesson will repair, without charge, for the lifetime of the original owner, any Smith & Wesson® handgun purchased on or after February 1, 1989, and any M&P®15 series rifle, that is found to have a defect in material or workmanship. Eligibility for this Lifetime Service Policy requires returning the Product Registration Card within 30 days of purchase. The Lifetime Service Policy covers functional defects; it does not include the firearm's finish, grips, magazines or sights. The Lifetime Service Policy is in addition to and not an extension of the Smith & Wesson Warranty.

This warranty gives you specific legal rights. You may also have other rights that vary from state to state.

NOTE: All liability is excluded in the event that the instructions in the Smith & Wesson® manual are not observed.

CONTACT AND SHIPPING INFORMATION

For Owners Within The United States

NOTE: A Return Merchandise Authorization (**RMA**) is the first step in the process of returning a product in order to receive a repair, replacement or refund. Please contact Smith & Wesson's Customer Service Dept. (via e-mail: qa@smith-wesson.com or by phone at 1-800-331-0852 ext. 4125) to obtain authorization to return your firearm so we can process it quickly and efficiently. The RMA number that is supplied by Smith & Wesson® must be displayed on the outside of the returned product's packaging; returns without an RMA number will be routed differently which will result in delayed processing.

The issuance of an Return Merchandise Authorization (**RMA**) allows Smith & Wesson® an opportunity to try to diagnose and correct a customer's concerns with the product (such as ammunition problems) before it is returned. Accordingly, please contact us before returning your Smith & Wesson® firearm.

STEP 1: CONTACT CUSTOMER SERVICE

Tel: 1-800-331-0852 • 1-413-781-8300 ext. 4125
E-mail: qa@smith-wesson.com

STEP 2: RETURNS - FOR SERVICE

SEND ALL FIREARMS TO:
Smith & Wesson
2100 Roosevelt Avenue • Springfield, MA 01104

Should your Smith & Wesson® firearm require service, it should be returned to the Smith & Wesson® factory.

- Call or e-mail the Customer Service Dept. for authorization and shipping instructions.
- Ensure that the firearm is unloaded.
- **Do not attempt to ship a firearm via US Postal Service; only federally licensed dealers may ship a firearm by US Postal Service.**
- **DO NOT SHIP ANY AMMUNITION.**
- Enclose a letter which includes your full name and address (no P.O. Boxes, please), daytime telephone number, e-mail address, the serial number of the firearm, and details of the problem experienced (stating the brand and type of ammunition used when the problem occurred) or work desired.
- Record the serial number before shipping, in case you wish to check on the repair status of your firearm.

CONTACT AND SHIPPING INFORMATION CONTINUED

- Please remove all custom parts and accessories, such as stocks, special sights and scopes, or slings from your firearm before returning.
- Place the firearm in its original case or in a similarly secure container and pack it securely.
- The package must NOT bear any markings which indicate the identity of the contents.
- It is most important that you comply with federal, state, and local laws and regulations. The following guidelines are meant to help, but you must seek assistance from the appropriate authorities if necessary.
- If your firearm must be replaced, it may be necessary to ship the replacement to a dealer rather than directly to you. You will be requested to furnish a signed FFL (Federal Firearms License) from your dealer in such an instance.
- Warranty repair work will begin upon receipt and examination of the firearm. In the case of repairs or work not covered by the warranty, a quotation covering the cost of the work plus round trip transportation charges will be sent to you. Repairs or modification will be scheduled upon receipt of payment.
- A parts list can be obtained by contacting Smith & Wesson® Customer Service.



WARNING: YOU MAY PURCHASE ACCESSORIES FOR YOUR SMITH & WESSON® FIREARM. YOU MUST HAVE SOME OF THESE PARTS INSTALLED BY A GUNSMITH QUALIFIED TO PERFORM SERVICE ON SMITH & WESSON® FIREARMS. YOU MUST NEVER ATTEMPT TO MODIFY YOUR FIREARM OR INSTALL REPLACEMENT PARTS IN YOUR FIREARM. ALWAYS USE A QUALIFIED SMITH & WESSON® GUNSMITH EVEN IF THE REPAIR SEEMS TO BE SIMPLE.

CUSTOM SERVICE

- We understand that Smith & Wesson gun owners may want to enhance their guns with custom gunsmithing, refinishing or accessories. Our gunsmiths offer specialized services and exclusive products to enhance your shooting experience.
- Accessories for your Smith & Wesson® firearm are available from your local Smith & Wesson® Stocking Dealer, or directly from Smith & Wesson.
- Contact the Customer Service Department at 1-800-331-0852 extension 4125 for information about these services.

When ordering directly from the factory, please provide the following information:

- Model Number
- Dash Number
- Serial Number
- Approximate date of purchase
- Complete Return Address
- VISA/Discover/MasterCard Number & Expiration Date
- For Foreign Orders Only, Fax Number or E-mail Address

This handgun is not equipped with a device that fully blocks use by unauthorized users. More than 200,000 firearms like this one are stolen from their owners every year in the United States. In addition, there are more than a thousand suicides each year by younger children and teenagers who get access to firearms. Hundreds more die from accidental discharge. It is likely that many more children sustain serious wounds or inflict such wounds accidentally on others. In order to limit the chance of such misuse, it is imperative that you keep this pistol locked in a secure place and take other steps necessary to limit the possibility of theft or accident. Failure to take reasonable preventative steps may result in innocent lives being lost, and in some circumstances may result in your liability for these deaths.

The certification below is required only for handguns sold in the United States with a barrel length shorter than 3".

Smith & Wesson Inc. hereby certifies average accuracy test results for all new handguns with a barrel shorter than 3" as follows:

7 yards	14 yards	21 yards
1.7"	3.9"	6.3"

This certification is based on tests conducted by Smith & Wesson Inc. using a fixed handgun, rest and firing ammunition manufactured by a member of the Shooting Arms and Ammunition Manufacturers Institute (SAAMI) as defined in ANSI/SAAMI Z299.3-1993.

This certification represents actual tests based on several handguns, selected at random. Your particular handgun may have accuracy better than the results stated in this certification.

BATTERY WARNINGS



WARNING: IF A BATTERY OPERATED ACCESSORY OR ATTACHMENT (I.E. LASER, OPTICAL SIGHT OR FLASH-LIGHT, ETC.) IS SUPPLIED OR USED WITH THIS FIRE-ARM, THE FOLLOWING WARNINGS AND INSTRUCTIONS MUST BE ADHERED TO.



WARNING: KEEP BATTERIES AWAY FROM CHILDREN. THERE IS A CHEMICAL BURN HAZARD ASSOCIATED WITH BATTERIES.



WARNING: IF A NEW OR USED LITHIUM BUTTON/ COIN CELL BATTERY IS SWALLOWED OR ENTERS THE BODY, IT CAN CAUSE SEVERE INTERNAL BURNS AND CAN LEAD TO DEATH IN AS LITTLE AS 2 HOURS. ALWAYS COMPLETELY SECURE THE BATTERY COMPARTMENT. IF THE BATTERY COMPARTMENT DOES NOT CLOSE SECURELY, STOP USING THE PRODUCT, REMOVE THE BATTERIES, AND KEEP IT AWAY FROM CHILDREN. IF YOU THINK BATTERIES MIGHT HAVE BEEN SWALLOWED OR PLACED INSIDE ANY PART OF THE BODY, SEEK IMMEDIATE MEDICAL ATTENTION.

- When used correctly, batteries provide a safe and dependable source of portable power. However, misuse or abuse may result in leakage, fire, or explosion.
- Batteries can explode or leak and cause burns if installed backwards, disassembled, charged, or exposed to water, fire or high temperature.
- Always take care to install your batteries correctly observing the “+” and “-” marks on the battery and the device.
- Always replace the whole set of batteries at one time, taking care not to mix old and new batteries, or batteries of different types.
- Store unused batteries in their original packaging and away from metal objects that may short-circuit them.
- Remove discharged batteries from equipment promptly to avoid possible damage from leakage.
- Never dispose of batteries in fire. (Failure to observe this precaution may result in an explosion.)
- The batteries are supplied in a charged state and are not designed for recharging. Recharging may cause leakage, fire, or explosion.
- The batteries should be disposed of properly, including keeping them away from children.
- Dispose of used batteries immediately. Even used batteries may cause injury.

INTERNATIONAL WARRANTY CENTERS

For Owners Outside The United States

NOTE: Addresses and contact information for International Warranty Centers is available on the Smith & Wesson® website at www.smith-wesson.com or by calling Customer Service toll-free at 1-800-331-0852 ext 4125.

PATENT INFORMATION

- This product may be covered by one or more patents. Visit www.smith-wesson.com for virtual patent information.

PORTED BARREL WARNINGS

On Those Pistols So-Equipped



WARNING: ALWAYS KEEP YOUR FACE, HANDS, FINGERS, OR ANY OTHER BODY PARTS AWAY FROM THE BARREL/SLIDE PORTS DURING FIRING. ALWAYS ENSURE THAT BYSTANDERS ARE AWAY FROM THE BARREL/SLIDE PORTS DURING FIRING. PARTICLES AND HOT GAS WILL BE FORCED OUT OF THE BARREL/SLIDE PORTS DURING NORMAL USE. FAILURE TO FOLLOW THIS WARNING WILL CAUSE SERIOUS PERSONAL INJURY AND MAY ALSO RESULT IN DAMAGE TO PROPERTY (CLOTHING, ETC.).

- NEVER CYCLE THE SLIDE WITH YOUR HAND OVER THE PORTS.
- DO NOT SHOOT A PISTOL WITH A PORTED BARREL “FROM THE HIP” OR FROM A RETENTION POSITION (WHEN THE FIRE-ARM IS IN CLOSE PROXIMITY TO ANY PART OF THE BODY).
- USE CAUTION WHEN SHOOTING TO AVOID ANY OBJECTS IN PROXIMITY (OVERHEAD AND TO THE SIDES) THAT COULD BE DAMAGED BY THE PARTICLES AND HOT GAS FORCED FROM THE BARREL/SLIDE PORTS DURING FIRING.



WARNING: NEVER INSTALL A PORTED BARREL IN A PISTOL WITH A NON-PORTED SLIDE. FAILURE TO FOLLOW THIS WARNING WILL CAUSE SERIOUS PERSONAL INJURY AND DAMAGE TO PROPERTY.

FIGURE 92

Observe all WARNINGS.



On those models so-equipped

Showing location of exhaust port on typical M&P® 380 SHIELD™ EZ® pistol so-equipped



3012265

Smith & Wesson

2100 Roosevelt Avenue • Springfield, MA 01104
www.smith-wesson.com

p/n 3012265

REVM&P_ 380_SHIELD_EZ-021520