

# INSTRUCTION MANUAL FOR



## **RUGER® SR22®**

**MANUAL SAFETY MODEL PISTOL**



**– Rugged, Reliable Firearms® –**



**READ THE INSTRUCTIONS AND  
WARNINGS IN THIS MANUAL CAREFULLY  
BEFORE USING THIS FIREARM**

© 2020 Sturm, Ruger & Co., Inc.

This manual may not be reproduced in whole or in part without the express written permission of Sturm, Ruger & Co., Inc.

**For Service on This Model Please Call:  
(336) 949-5200 (See p. 38)**

**THIS INSTRUCTION MANUAL SHOULD ALWAYS ACCOMPANY THIS FIREARM AND BE  
TRANSFERRED WITH IT UPON CHANGE OF OWNERSHIP, OR WHEN THE FIREARM IS LOANED  
OR PRESENTED TO ANOTHER PERSON**

Ruger.com

**AX 3/2020 R9**

## State-By-State Warnings

Certain states require by law that their own specified warning notices in larger-than-normal type be conspicuously included by the manufacturer, distributor or retailer with firearms sold in that state. Sturm, Ruger & Co., Inc. sells its products in compliance with applicable laws and regulations. Because our products may be sold in these states, we include the following:

### California:

#### **WARNING**

“Firearms must be handled responsibly and securely stored to prevent access by children and other unauthorized users. California has strict laws pertaining to firearms, and you may be fined or imprisoned if you fail to comply with them. Visit the Web site of the California Attorney General at <https://oag.ca.gov/firearms> for information on firearm laws applicable to you and how you can comply.

Prevent child access by always keeping guns locked away and unloaded when not in use. If you keep a loaded firearm where a child obtains and improperly uses it, you may be fined or sent to prison.”

#### **ADVERTENCIA**

“Las armas de fuego deben manipularse de manera responsable y segura para evitar el acceso de niños y otros usuarios no autorizados. California tiene leyes estrictas relacionadas con armas de fuego, y usted puede ser multado o encarcelado si no las cumple. Visite el sitio web del Procurador General de California en <https://oag.ca.gov/firearms> para obtener información sobre las leyes de armas de fuego que le son aplicables y cómo puede cumplirlas.

A los niños los atraen las armas de fuego y las pueden hacer funcionar. Ellos pueden causarse lesiones graves y la muerte. Evite que los niños tengan acceso a las armas de fuego guardándolas siempre con llave y descargadas cuando no las esté utilizando. Si usted tiene un arma de fuego cargada en un lugar en que un niño tiene acceso a ella y la usa indebidamente, le pueden dar una multa o enviarlo a la cárcel.”

## **Connecticut:**

“UNLAWFUL STORAGE OF A LOADED FIREARM MAY RESULT IN IMPRISONMENT OR FINE.”

## **Florida:**

“IT IS UNLAWFUL, AND PUNISHABLE BY IMPRISONMENT AND FINE, FOR ANY ADULT TO STORE OR LEAVE A FIREARM IN ANY PLACE WITHIN THE REACH OR EASY ACCESS OF A MINOR UNDER 18 YEARS OF AGE OR TO KNOWINGLY SELL OR OTHERWISE TRANSFER OWNERSHIP OR POSSESSION OF A FIREARM TO A MINOR OR A PERSON OF UNSOUND MIND.”

## **Maine:**

“ENDANGERING THE WELFARE OF A CHILD IS A CRIME. IF YOU LEAVE A FIREARM AND AMMUNITION WITHIN EASY ACCESS OF A CHILD, YOU MAY BE SUBJECT TO FINE, IMPRISONMENT OR BOTH. KEEP FIREARMS AND AMMUNITION SEPARATE. KEEP FIREARMS AND AMMUNITION LOCKED UP. USE TRIGGER LOCKS.”

## **Maryland:**

“WARNING: Children can operate firearms which may cause death or serious injury. It is a crime to store or leave a loaded firearm in any location where an individual knew or should have known that an unsupervised minor would gain access to the firearm. Store your firearm responsibly!”

## **Massachusetts:**

“WARNING FROM THE MASSACHUSETTS ATTORNEY GENERAL: This handgun is not equipped with a device that fully blocks use by unauthorized users. More than 200,000 firearms like this one are stolen from their owners every year in the United States. In addition, there are more than a thousand suicides each year by younger children and teenagers who get access to firearms. Hundreds more die from accidental discharge. It is likely that many more children sustain serious wounds, or inflict such wounds accidentally on others. In order to limit the chance of such misuse, it is imperative that you keep this weapon locked in a secure place and take other steps necessary to limit the possibility of theft or accident. Failure to take reasonable preventive steps may result in innocent lives being lost, and in some circumstances may result in your liability for these deaths.”

“IT IS UNLAWFUL TO STORE OR KEEP A FIREARM, RIFLE, SHOTGUN OR MACHINE GUN IN ANY PLACE UNLESS THAT WEAPON IS EQUIPPED WITH A TAMPER-RESISTANT SAFETY DEVICE OR IS STORED OR KEPT IN A SECURELY LOCKED CONTAINER.”

## **New Jersey:**

“IT IS A CRIMINAL OFFENSE TO LEAVE A LOADED FIREARM WITHIN EASY ACCESS OF A MINOR.”

## **New York City:**

“THE USE OF A LOCKING DEVICE OR SAFETY LOCK IS ONLY ONE ASPECT OF RESPONSIBLE FIREARM STORAGE. FOR INCREASED SAFETY, FIREARMS SHOULD BE STORED UNLOADED AND LOCKED IN A LOCATION THAT IS BOTH SEPARATE FROM THEIR AMMUNITION AND INACCESSIBLE TO CHILDREN AND UNAUTHORIZED PERSONS.”

**North Carolina:**

“IT IS UNLAWFUL TO STORE OR LEAVE A FIREARM THAT CAN BE DISCHARGED IN A MANNER THAT A REASONABLE PERSON SHOULD KNOW IS ACCESSIBLE TO A MINOR.”

**Texas:**

“IT IS UNLAWFUL TO STORE, TRANSPORT, OR ABANDON AN UNSECURED FIREARM IN A PLACE WHERE CHILDREN ARE LIKELY TO BE AND CAN OBTAIN ACCESS TO THE FIREARM.”

**Wisconsin:**

“IF YOU LEAVE A LOADED FIREARM WITHIN THE REACH OR EASY ACCESS OF A CHILD YOU MAY BE FINED OR IMPRISONED OR BOTH IF THE CHILD IMPROPERLY DISCHARGES, POSSESSES, OR EXHIBITS THE FIREARM.”

\* \* \* \* \*

Please check with your licensed retailer or state police for additional warnings which may be required by local law or regulation. Such regulations change constantly, and local authorities are in the best position to advise you on such legal matters.

**FIREARMS SAFETY IS YOUR RESPONSIBILITY**

**SAFETY MUST BE THE FIRST AND CONSTANT  
CONSIDERATION OF EVERY PERSON WHO HANDLES  
FIREARMS AND AMMUNITION.**

This Instruction Manual is designed to assist you in learning how to use and care for your **RUGER® SR22®** pistol properly. Please contact us if you have any questions.

Only when you are certain you fully understand the manual and can properly carry out its instructions should you practice loading, unloading, etc. with live ammunition. If you have any doubts about your ability to handle or use a particular type of firearm safely, you should seek supervised instruction. Such personalized instruction often is available from local firearm retailers, gun clubs or police departments. If none of these sources can help, visit [nra.org](http://nra.org) or write to the following address:

National Rifle Association  
11250 Waples Mill Road  
Fairfax, VA 22030-7400

The person possessing a firearm has a full-time job. You cannot guess; you cannot forget. You must know how to use your firearm safely. **Do not use any firearm without having a complete understanding of its particular characteristics and safe use.** Remember: There is no such thing as a foolproof firearm.

# TABLE OF CONTENTS

State-By-State Warnings .....	2
Nomenclature .....	8
Locking Device Installation Instructions .....	9
General Information and Mechanical Characteristics .....	11
Operation of Manual Safety .....	12
Ammunition .....	13
To Load and Fire .....	14
Visual Inspection Port .....	17
Operation of Magazine Disconnect .....	18
Dry Firing .....	18
To Uncock (Decock) The Pistol .....	19
To Unload .....	19
To Reload The Pistol .....	21
To Extract and Eject a Chambered Cartridge .....	21
To Clear a Malfunction (“Jam” or “Misfire”) .....	22
To Minimize Malfunctions (“Jams” or “Misfires”) .....	23
Disassembly .....	23
Removing the Barrel .....	26
Reassembly .....	26
Check Your Pistol’s Function .....	30
Interchangeable Grip Sleeves .....	31
Sight Adjustment .....	32
Adapter/Barrel Cap Removal and Installation .....	33
Magazine Inspection and Care .....	35
Care and Cleaning .....	36
Storage .....	37
Service and Parts Policy .....	38
Shipping Firearms for Repair .....	38
Ordering Parts .....	39
Parts List .....	40
Exploded View .....	41
<b>The Basic Rules of Safe Firearms Handling .....</b>	<b>42</b>
Warranty Information .....	48

“Ruger” is a registered U.S. trademark.

 <b>WARNINGS OF GREAT IMPORTANCE ARE FOUND ON THE FOLLOWING PAGES:</b>			
Locking Devices	9	Unloading	19
Alterations	11	Malfunctions	22
Manual Safety	13	Disassembly	25
Ammunition	13	Lubrication	36
Lead Exposure	14	Storage	37
Slide Retraction	16	Shipping	38
Firing	16	Parts Purchasers	39
Handling	18		
<b>OTHER CAUTIONS AND WARNINGS APPEAR THROUGHOUT THE MANUAL.</b>			

# NOMENCLATURE

**Sights** have high-visibility white dots both front and rear.

**Slide's** open-top design minimizes possibility of jamming and allows shooter to clear any malfunction by hand.

Grooved, exposed **hammer spur** enables the shooter to cock the hammer easily for accurate, single-action firing if desired.



**Manual Safety**

Rigid one-piece polyurethane **grip frame** reinforced with long glass fiber.

**Slide stop** holds the slide open and is activated automatically when last shot is fired, or can be manually operated.

Double-action mechanism and strongly curved **trigger** allow cocking and firing to be accomplished with a single pull of the trigger.

The ambidextrous **magazine latch** permits positive retention and quick removal of magazine.

**Rear sight** is adjustable for windage and elevation.

**Visual inspection port** provides visual indication that chamber is loaded.



When ambidextrous **manual safety** is in "safe" position, the firing pin is blocked so that it cannot make contact with the cartridge. Additionally, if the hammer is decocked using the safety, the hammer is held away from the firing pin. If the decock is not used, the hammer can be thumb cocked slightly so that the hammer rests on the decock hammer stop.

**Accessory Rail** accepts most lights and sighting devices designed to fit the M1913 Picatinny Standard Rail.

Oversize **trigger guard** permits shooting with gloved hand.

**Magazine Latch**

**Magazine Disconnect** is designed to prevent the pistol from being fired when the magazine is removed, even if a live round remains in the firing chamber.



## LOCKING DEVICE INSTALLATION INSTRUCTIONS



### WARNING – USE OF LOCKING DEVICES



**Do not store keys  
in lock.**

- Always keep your firearm pointed in a safe direction, including when you are installing or removing your locking device.
- Always verify that your firearm is completely **unloaded** before installing your locking device.
- Do **not** install locking devices in the trigger guard; always keep your fingers and locking device outside the trigger guard during device installation and removal.
- Store firearms, ammunition and keys separately and securely, away from children and careless adults; do **not** store your firearm with the keys in the locking device.
- Do not attempt to work the action of your firearm with the locking device in place; this may damage your firearm.
- While locking devices are an important aid to security measures, they are not a substitute for safe firearm handling and proper storage. Remember that any mechanical device can be bypassed with enough time, knowledge, determination and equipment.

**LOCKING DEVICES MUST BE USED  
SAFELY AND RESPONSIBLY**

It is important to use the locking device on your Ruger® firearm when the firearm is stored or immediate use is not planned.

Keep the muzzle pointed in a safe direction and your fingers outside the trigger guard at all times!

#### **To Install the Factory-Supplied Locking Device:**

1. **Be sure the firearm is completely unloaded and contains no cartridges or cartridge cases!**
2. Remove the magazine from your pistol.
3. Open the action completely. Use the slide stop to keep the action open during installation of the locking device.

4. Insert the cable directly to your pistol as shown in Figure 1.
5. To lock: With the key turned to the farthest clockwise position, insert the loose end of the cable into the lock. Turn the key counterclockwise and remove the key.
6. Once the lock is securely closed, pull firmly on the lock to test the connection and be sure it is locked. **Do not leave or store your firearm with the key in the lock!** Store your locked unloaded firearm and the key in secure, separate locations, away from ammunition, children or unauthorized adults.



Figure 1

**Correct installation of the lock on a Ruger® SR22® pistol.**

**FIREARMS ARE DANGEROUS WEAPONS.  
READ THE INSTRUCTIONS AND WARNINGS  
IN THIS MANUAL THOROUGHLY AND  
CAREFULLY BEFORE USING.**

 <b>WARNING - ALTERATIONS</b>	
	This product was designed to function properly in its original condition. Alterations can make it unsafe. Do not alter any part or add or substitute parts or accessories not made by Sturm, Ruger & Co., Inc.
	<b>DO NOT ALTER ANY FIREARM</b>

## **GENERAL INFORMATION AND MECHANICAL CHARACTERISTICS**

The **RUGER® SR22®** pistol is a rimfire, traditional double-action (double-action first shot followed by single action) magazine-fed, autoloading, blowback pistol chambered in 22 Long Rifle (22LR) cartridge. This pistol incorporates a fixed barrel and features an aircraft-grade aluminum alloy slide and glass filled nylon, polymer frame construction. Other features with which users should be thoroughly familiar include:

**Action:** The action of the **RUGER® SR22®** pistol is of the straight blowback type that utilizes a fixed barrel design in which the slide is held closed by the recoil spring at the moment of firing. After firing, the slide recoils to the rear permitting the extraction and ejection of the spent cartridge case. Upon return of the slide to its forward position by the recoil spring, a fresh cartridge is picked up from the magazine and loaded into the barrel chamber.

**The user of this or any autoloading pistol must always remember that when fired, it automatically reloads and recocks itself, so that simply pulling the trigger will fire the pistol again. Therefore, an autoloading pistol user must be particularly conscious to always keep the pistol pointed in a safe direction.**

**Slide Stop:** When the last shot has been fired and the magazine is empty, the slide stop automatically holds the slide open. When there is an empty magazine in the pistol and the slide is retracted manually, the slide stop will also automatically hold the slide open. If a loaded magazine is inserted in the pistol when the slide is closed and the slide is then retracted fully, the slide stop will not automatically hold open the slide. The user can actuate the slide stop mechanism to hold the slide open at any time by retracting the slide and pushing the slide stop up.

The slide stop can be released by drawing back slightly on the slide and depressing the slide stop thumbpiece. When the slide is released, it will move forward under pressure from the recoil spring.

The slide stop is spring loaded downward. Therefore, when there is a loaded magazine in place and the pistol is jarred, the slide can fly forward and chamber a cartridge. For this reason and as an essential safety practice, **the user should always be careful to keep fingers away from the trigger, keep the safety on, and always keep the pistol pointed in a safe direction.**

**Magazines:** The **RUGER® SR22®** pistol (22 Long Rifle) magazines are **not** interchangeable with Ruger pistol magazines of **any** other pistol or caliber even though they may appear similar and may hold other cartridges. Use only **GENUINE RUGER® FACTORY** magazines designated for your firearm. The use of incorrect magazines in any pistol will result in malfunctions.

**DAMAGED, NON-STANDARD, OR IMPROPERLY  
ASSEMBLED MAGAZINES SHOULD NOT BE USED.  
THEY CAN CAUSE THE PISTOL TO MALFUNCTION.**

## OPERATION OF MANUAL SAFETY

The model you have selected is equipped with special, manual, ambidextrous safety levers that also allow you to decock (uncock) a cocked pistol without manipulating the trigger. Conventional thumb decocking procedures are therefore not necessary and should not be employed with this pistol.

To apply the manual safety and decock the pistol, **point the pistol in a safe direction**. Move either the right- or left-hand safety lever downward and fully to the “safe” position (see Figure 2). When the safety is moved fully downward to the “safe” position, the red area is covered by the safety lever. At this point the hammer will fall to the decocked position and rest on the hammer blocker. With the safety in the “safe” position the trigger is disconnected from the hammer so that the hammer cannot be actuated even though the trigger can be pulled. The trigger is also disconnected from the firing pin blocker so that the firing pin blocker will not allow the firing pin to move forward and contact the primer even though the trigger is pulled. Last of all, when the hammer is decocked in this manner, it rests on a hammer blocker, which prevents the hammer from contacting the firing pin.

**“SAFE” POSITION**

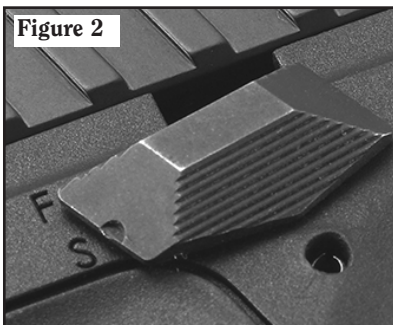

**“FIRE” POSITION**

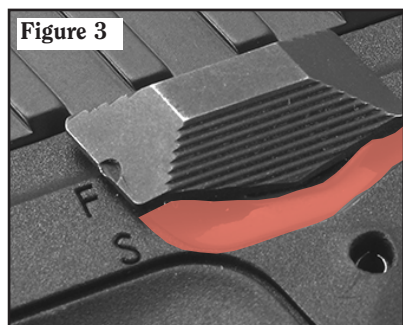



## WARNING - MANUAL SAFETY



Placing the safety in an intermediate position between “safe” and “fire” can result in the user thinking the pistol is in a safe or fire position when it is not. Pulling the trigger with the safety in an intermediate position may cause the pistol to fire. Therefore, always move the safety fully to its intended position and then check to be sure it is where you want it to be. Unless the red area is completely covered, the safety is not “ON.” Unless the red area is fully visible, the pistol is not absolutely ready to fire.

**NEVER PUT SAFETY 1/2 ON**

## AMMUNITION

The **RUGER® SR22®** pistols are chambered for the 22 Long Rifle cartridge. Do not attempt to load any other 22 caliber cartridges into the magazine or chamber of the pistol.

The **RUGER® SR22®** pistols are compatible with all factory ammunition of the correct caliber loaded to U.S. Industry Standards, including high-velocity and hollow-point loads. However, sub-sonic or match-grade ammunition may not have sufficient energy to cycle the slide. If you find that the slide does not cycle fully, try another brand of ammunition.



## WARNING – AMMUNITION



Use only new, factory ammunition of the correct caliber.



Death, serious injury, and damage can result from the wrong ammunition, bore obstructions, powder overloads or incorrect cartridge components.

Always wear shooting glasses and hearing protection.

**IMPROPER AMMUNITION  
DESTROYS FIREARMS**

## AMMUNITION (CARTRIDGES) NOTICE

WE SPECIFICALLY DISCLAIM RESPONSIBILITY FOR ANY DAMAGE OR INJURY WHATSOEVER OCCURRING IN CONNECTION WITH, OR AS A RESULT OF, THE USE IN RUGER FIREARMS OF FAULTY, OR NON-STANDARD, OR "RE-MANUFACTURED", OR HAND-LOADED (RELOADED) AMMUNITION, OR OF CARTRIDGES OTHER THAN THOSE FOR WHICH THE FIREARM WAS ORIGINALLY CHAMBERED.

	
<b>WARNING - LEAD EXPOSURE</b>	
	Discharging firearms in poorly ventilated areas, cleaning firearms, or handling ammunition may result in exposure to lead and other substances known to the State of California to cause birth defects, reproductive harm, and other serious physical injury. Have adequate ventilation at all times. Wash hands thoroughly after exposure.
	<b>SHOOTING OR CLEANING FIREARMS MAY EXPOSE YOU TO LEAD</b>

## TO LOAD AND FIRE

Practice this important aspect of safe firearm handling with an unloaded pistol until you can perform each of the steps described below with skill and confidence. **But before you do anything with the pistol, first read completely through this manual.**

1. **Be certain the muzzle is pointed in a safe direction.** (See "The Basic Rules of Safe Firearms Handling," page 42.)
2. **Move either the right- or left-hand safety lever fully downward to its "safe" position so that the red area is fully covered.** (See Figures 2 and 3 on page 12.)
3. Press the magazine latch inward from either the left or right side and remove the magazine from the frame. **NOTE:** The magazine is designed to fall free of the frame of its own weight when unloaded, the slide is locked open and the pistol is held in the normal firing position, but you should always prevent possible damage to the magazine by not letting it drop to the ground unless rapid reloading is absolutely necessary.
4. Place ten (10) or fewer 22 Long Rifle cartridges into the magazine from the top.
5. Insert the magazine into the frame, taking care that the magazine is locked in place by the magazine latch. Slamming the magazine into the frame forcibly is not necessary, though the magazine may require a light tap to seat.



6. Hold the pistol firmly in the shooting hand but **do not touch the trigger**. **Keep the pistol pointed in a safe direction and the safety “on.”** With the thumb and forefinger of the other hand grasp the **rear** of the slide and pull the slide to the rear as far as it will go (see Figure 4, below and “Slide Retraction Warning,” p. 16). When released, the slide will fly forward to strip the top cartridge from the magazine and chamber it. The safety mechanism drops the hammer automatically as the slide moves forward.

The trigger is inoperable when the safety is fully engaged in its “safe” position (lever fully down and red dot covered; see Figure 2 on page 12). **WARNING:** **The pistol is ready for instant use in the single-action mode once the slide moves forward if the safety is in the “fire” position. Be careful!**

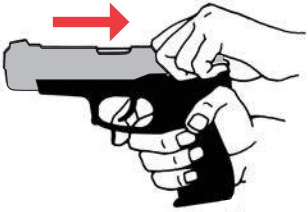

**Figure 4**  
Slide in Retracted Position

7. **If the pistol is not to be fired immediately, the safety should remain in its “safe” position** (see Figure 2, p. 12).
8. If the pistol is to be fired immediately, the manual safety can be rotated upward to its “fire” position (see Figure 3, p. 12). The firing pin is still blocked at all times by the internal firing pin block unless the trigger is pulled all the way to the rear.
9. **The pistol is ready for instant use once the safety is disengaged.** When the pistol is in the “uncocked” mode (hammer forward), the first shot can be fired double-action by pulling the trigger all the way to the rear, which cocks the hammer and then fires the pistol. Subsequent shots are fired single-action until the magazine is empty, the hammer being cocked by the slide as it recoils from each shot. Note that the trigger pull is much lighter for these subsequent shots.
10. For greater accuracy and consistent trigger pull, the hammer may be manually cocked by the shooter before the first shot is fired once the safety is “off.” **Keep your finger off the trigger while cocking the hammer!** The hammer will be automatically cocked as described above for subsequent shots.

<b>! WARNING - SLIDE RETRACTION</b>	
	<p>The slide should always be pulled rearward (“retracted”) by pulling the <u>rear</u> portion of the slide in the vicinity of the safety, the decock-only lever, or the serrations (depending upon model). <b>Always keep fingers away from trigger!</b></p>
	<p><b>Never put any part of your hands or body over the muzzle while retracting the slide</b> for loading, unloading, inspection, or clearing a malfunction.</p>
<p><b>KEEP HANDS AWAY FROM MUZZLE AND FINGER OFF TRIGGER</b></p>	

11. Immediately following the firing of a shot, and if a subsequent shot is not to be fired at once, put the safety in its “safe” position (lever fully down and red area covered) while the pistol is still pointing in a safe direction downrange. This will also uncock (decock) the pistol.
12. When the last cartridge loaded into the pistol has been fired, the magazine follower presses the slide stop upward to engage the slide, automatically holding the action open. **If the slide is shut, the shooter should always assume that there is a cartridge in the chamber!**

Don't rely on your memory to know if a firearm or magazine is loaded. With the pistol pointed in a safe direction, visually inspect the magazine and chamber.

<b>! WARNING - FIRING</b>	
	<p>The slide automatically opens and shuts quickly while firing. Keep face and hands away from rear. Hot brass is ejected quickly and can burn you. Always wear shooting glasses and hearing protection.</p>
<p><b>SLIDE OPENS FAST - HOT BRASS EJECTED</b></p>	



## VISUAL INSPECTION PORT

You should always treat every firearm as though it is loaded and always keep the muzzle pointed in a safe direction. Never rely upon any safety or mechanical device to justify unsafe or careless firearm handling. In order to assist you in determining the presence of a cartridge in the chamber of your **RUGER® SR22®** pistol, it is equipped with a loaded chamber indicator. The indicator is a hole in the top of the barrel and the slide at the back of the barrel. (See Figure 5.) This is a view port that allows the user to look in and see the presence of a cartridge in the chamber.

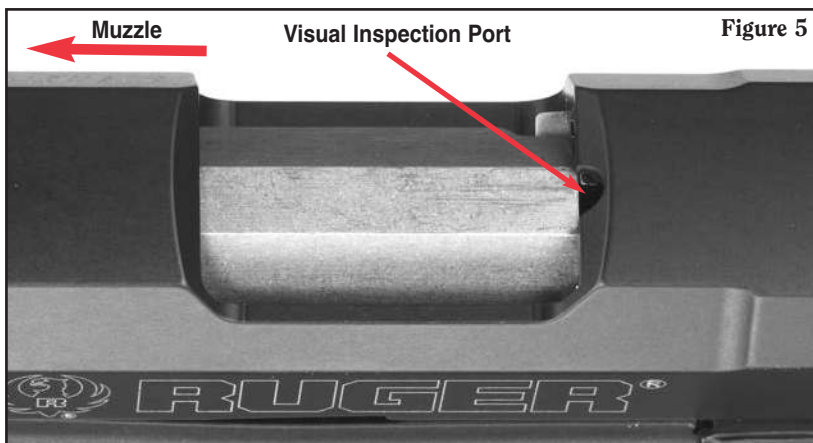

**!** NEVER RELY ON YOUR MEMORY OR ANY LOADED CHAMBER INDICATOR TO KNOW IF A FIREARM IS LOADED. ANY MECHANICAL DEVICE CAN FAIL. ALWAYS VISUALLY CHECK THE CHAMBER BY RETRACTING THE SLIDE AND EXAMINING THE CHAMBER TO BE SURE WHETHER IT IS EMPTY OR LOADED.

## OPERATION OF MAGAZINE DISCONNECT

Your **RUGER® SR22®** pistol is equipped with a magazine disconnect. This device prevents firing if the magazine is removed from the pistol. You will not be able to use your **SR22®** pistol as a single loader or to fire the pistol with the magazine out of the pistol.



**REMEMBER THAT A ROUND MAY STILL BE IN THE CHAMBER AND THAT THE PISTOL MAY STILL BE LOADED EVEN IF THE MAGAZINE IS REMOVED. AS SOON AS AN EMPTY MAGAZINE IS INSERTED, A ROUND IN THE CHAMBER CAN BE FIRED BY PULLING THE TRIGGER.**

**BE CAREFUL! AS ALWAYS, YOU SHOULD NOT RELY UPON THE MAGAZINE DISCONNECT OR ANY OTHER MECHANICAL DEVICE OR SAFETY TO JUSTIFY CARELESS OR UNSAFE HANDLING OF ANY FIREARM.**

Don't rely on your memory to know if a firearm or magazine is loaded. With the pistol pointed in a safe direction, visually inspect the magazine and the chamber.



### WARNING - HANDLING

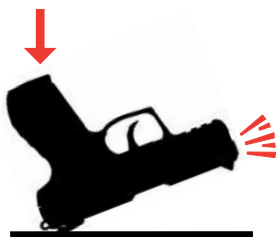

Do not load the pistol until you are ready to use it, and unload it immediately when you have completed shooting. (See "Warning - Unloading" on page 19.)

If dropped or struck, the pistol may fire. Keep chamber empty unless actually firing! Use the safety lever to decock pistol before moving with pistol or when not actually firing.

For maximum safety when carrying the pistol with a loaded magazine in place, the chamber should be empty, the slide should be closed, and the pistol should be decocked. **Never carry it cocked!** If placed into a holster, check it to be sure that the slide is not retracted far enough to either chamber a cartridge from the magazine or cock the pistol.

The user should never depend on any mechanical device to justify careless handling or permit the pistol to point in an unsafe direction. The shooter should always be alert to the possibility of accidental discharge. **The only absolutely safe pistol is one in which the slide is open, the chamber is empty, and there is no magazine in the firearm.**

**ANY FIREARM MAY FIRE IF DROPPED**

## DRY FIRING

Going through the actions of cocking, aiming and pulling the trigger on an unloaded firearm is known as "dry firing." Dry firing can be useful to learn the "feel" of your pistol. Be certain that the pistol is fully unloaded (both the chamber and magazine are empty) and that the pistol is pointing in a safe direction at all times, even when you are practicing dry firing. The **RUGER® SR22®** pistols can be dry-fired without damage to the firing pin or other components as long as the magazine is inserted.

**CAUTION:** The **RUGER® SR22®** pistols cannot fire with the magazine removed.

## TO UNCOCK (DECOCK) THE PISTOL

With the muzzle pointed in a safe direction, engage the safety fully (see Figures 6a & 6b). The hammer will drop near the end of the safety's travel. Although this may appear startling, it is important to note that the firing pin is blocked, thus preventing forward movement toward the cartridge; therefore, the pistol will not fire when the safety is applied. Manually decocking the hammer with the thumb is neither necessary nor recommended. Always use either the right- or left-hand safety lever. Remember that when you return the manual safety to the firing position, the pistol can fire when the trigger is pulled if a cartridge is in the chamber and the magazine is in the firearm.

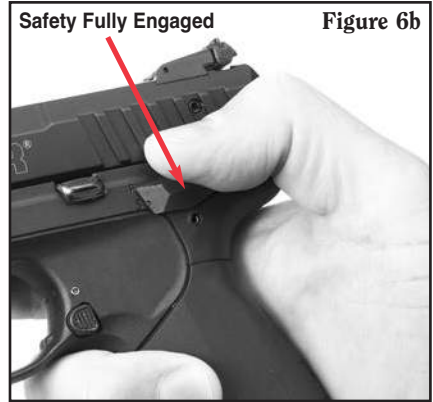

## TO UNLOAD

**WARNING:** This sequence must be followed exactly as outlined. Failure to do so can result in the chamber being unintentionally loaded with a live cartridge!

1. The muzzle of the pistol must be pointing in a safe direction at all times, and fingers should be outside of the trigger guard. Put the safety in its “safe” position (see Figure 2 on page 12) by rotating the safety fully downward until the red area is covered by the left safety lever. The safety can be engaged whether the pistol is cocked or not.

<b>⚠ WARNING - UNLOADING</b>	
	Removing magazine does not unload pistol! To unload, <u>first</u> remove magazine, <u>then</u> pull slide to rear, eject chambered cartridge, and <u>visually inspect chamber to be sure it is empty.</u> The safety should always be in its “Safe” position when loading or unloading the pistol. <u>Always point the pistol in a safe direction when loading or unloading.</u>
<b>REMOVING MAGAZINE DOES NOT UNLOAD CHAMBER</b>	

2. Remove the magazine from the pistol by pushing in on either the left or right magazine latch button. **REMEMBER that even though the magazine has been removed, a live round may remain in the chamber.** (See “Warning - Unloading,” page 19.)
3. Hold the pistol firmly and grasp the slide. Retract the slide to its rearmost position briskly to extract and eject any chambered cartridge. **Always double check visually that the chamber, breech-face, and the interior of the frame are clear of any live rounds.** When the slide is fully retracted, push upward on the slide stop, then allow the slide to move forward until it comes to rest with the rear projection of the slide stop resting in the notch on the lower left side of the slide.
4. To close the slide, **again check to be sure the chamber and breech-face are empty.** Pull the slide to its rearmost position and release it. The slide will snap forward. **Keep fingers out of ejection port on top of slide!**
5. If the magazine contains cartridges, they can be removed by sliding each cartridge forward and out of magazine, one at a time, until the magazine is empty.
6. Push empty (unloaded) magazine into frame until magazine latch locks it in place.

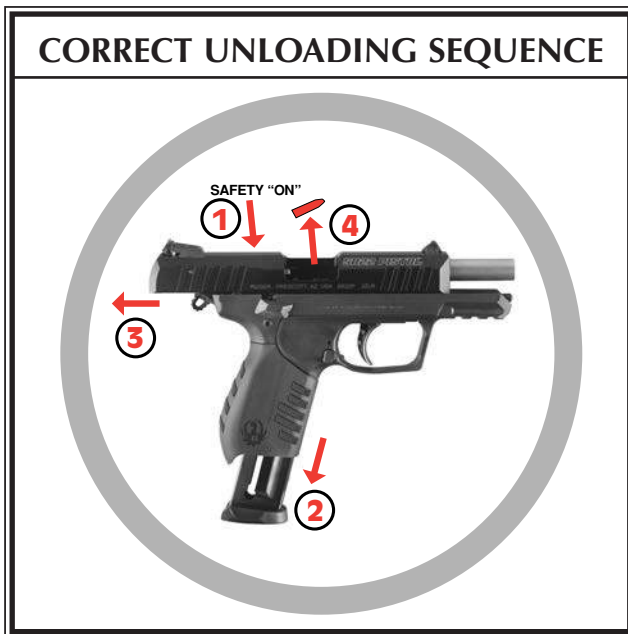

## TO RELOAD THE PISTOL

1. Firing all cartridges in the magazine and the chamber will cause the slide to automatically lock open. **Keep the pistol pointed in a safe direction.** Reloading can be accomplished by moving either the right- or left-hand safety lever fully downward to the “safe” position (lever fully down and red area covered) and then pressing in on the magazine latch with the thumb or forefinger. The magazine will fall free of the pistol of its own weight if the slide is locked open. To avoid the possibility of damage to the magazine, do not let it fall to the ground unless rapid reloading is absolutely necessary.
2. Insert a loaded magazine. **WARNING: The slide stop is held in place by the slide pressing against the rear of the slide stop. Therefore, when there is a loaded magazine in place and the pistol is jarred, the slide can fly forward and chamber a cartridge. For this reason and as an essential safety practice, the safety of the pistol should always be fully “on” except when the user is positioned to fire the firearm at a selected target.**
3. Release the slide to move forward by pulling the slide fully to the rear and releasing it. A cartridge will be chambered when the slide shuts. If you are ready to fire immediately, move the manual safety fully upward to its “Fire” position. **WARNING: The pistol is ready to fire in the “double-action” mode once manual safety is disengaged.** It can also be recocked to fire in the single-action mode.
4. If the pistol is not to be fired immediately, depress the manual safety fully until the hammer drops and **keep the safety “on” at all times except when actually firing.** When you are finished firing the pistol, unload it completely (see pages 19 - 20).



## TO EXTRACT AND EJECT A CHAMBERED CARTRIDGE

When the pistol is fired, the same gas pressure that drives the bullet forward also acts through the cartridge case to push the slide to the rear. The action causes extraction and ejection of the fired cartridge case. If a cartridge fails to fire or if the shooter wishes to eject the chambered cartridge manually, follow the procedure “To Unload” step 3, p. 20. When the slide is operated by hand, there can be a failure to extract the cartridge from the chamber, or a failure to eject the cartridge clear of the pistol. These failures usually are the result of the slide not being pulled rearward vigorously. From the foregoing, it is clear that the firearm user must:

1. **Always visually check the chamber and the breech-face after opening the slide to eject a chambered cartridge.** If the slide is not vigorously retracted when being operated by hand, the extracted cartridge can be “ejected” into the magazine-well of the grip frame or remain held to the breech-face by the extractor.
2. Also, if an empty magazine is in the pistol when the slide is being hand retracted to extract a cartridge, the cartridge may drop on top of the magazine or remain held to the breech-face by the extractor. Then when the slide goes forward, the cartridge will be chambered again! **Remember — always remove the magazine before clearing the chamber, and visually ensure that no cartridges remain in the firearm.**
3. **Thoroughly clean the chamber and the extractor as often as necessary.**

## TO CLEAR A MALFUNCTION ("JAM" or "MISFIRE")

1. Be certain the muzzle is continually pointed in a safe direction and that the safety lever is in the "safe" position (lever fully down).
2. If the misfire is the result of a cartridge not firing or unusual report (either louder or quieter than normal), keep the pistol pointed in a safe direction for 30 seconds prior to ejecting the chambered round or retracting the slide.
3. If possible, remove the magazine. It may be necessary to manually remove a jammed cartridge that has only been partially stripped from the magazine. If so, use extreme care. Lock the slide open with the slide stop before attempting to clear the jam. Drawing the slide fully to the rear may bring the jammed cartridge along. **Keep your face away from the ejection port during this operation.** When attempting to clear a jam, use only wood "tools" so that the cartridge will not be damaged or the primer ignited.
4. Visually check to make sure that all cartridges have been removed from the pistol. Safely dispose of any cartridges involved in a malfunction incident. **Do not use damaged ammunition in any firearm.**
5. Inspect the bore and chamber to ensure that they are not obstructed. **Failure to detect and correctly remove a bore obstruction can result in serious injury!**

 <b>WARNING - MALFUNCTIONS</b>	
	<p>Any autoloading pistol may occasionally malfunction. If a cartridge hangs up, jams, or binds when being chambered, do not attempt to force it into the chamber by pushing or striking the slide. Carefully remove it.</p> <p>Most failures of a cartridge to feed or to chamber properly are caused by a damaged magazine, incorrect firearm handling, insufficient lubrication, or improper ammunition.</p> <p>Whatever the cause, the user of the pistol must, above all, recognize that any cartridge jam can result in the potentially very dangerous situation of a cartridge discharging before it is properly chambered. If this happens, the cartridge case may rupture and its fragments fly out of the ejection port of the pistol with sufficient force to cause serious injury. <b>Always wear shooting glasses!</b></p>
	<p><b>HITTING PRIMER CAN BURST CARTRIDGE</b></p>

## TO MINIMIZE MALFUNCTIONS ("JAMS" or "MISFIRES")

1. If it appears that the jam was caused by the type of ammunition being used, try another brand, type, or lot number. Remember — use only factory ammunition of the correct caliber.
2. If changing ammunition does not at once eliminate malfunctions, then the following steps should be taken:
  - a. Thoroughly clean the pistol, paying particular attention to the removal of any accumulated grease and dirt. Use a bristle brush and solvent to remove grease and fouling from the breech-face, extractor, chamber, and feed ramp area immediately behind the chamber.
  - b. Check to be sure that the magazine spring firmly returns the magazine follower to the top of the magazine.
  - c. Check the magazine lips to be certain that they are free of nicks and burrs and that they are not deformed or cracked.
  - d. Remove excess oil and solvent from all cleaned components, load the magazine, and try the pistol again. Make sure you are following the correct loading and firing sequence as described in this manual.
  - e. If none of the above steps is effective, try a different magazine of Ruger® manufacture. If a new magazine does not function correctly, return the pistol and magazines to the Ruger Customer Service Department. (See "Shipping Firearms For Repair" on page 38.)
  - f. **Alterations to the pistol or use of non-Ruger magazines and accessories may cause malfunctions. (See "Warning - Alterations" on page 11.)**

## DISASSEMBLY

**Be sure pistol is unloaded!**

An on-line video demonstrating the disassembly and reassembly of the **SR22®** pistol can be viewed by going to **Ruger.com/TechTips**.

1. **Keep pistol pointed in a safe direction and place safety lever in the "safe" position** (lever fully down and red area covered). Press down on the left or right magazine latch and withdraw the magazine from the butt of pistol.
2. Pull the slide to rear and lock in open position by pressing upward on the slide stop (See Figure 7.) **Visually check to be sure the chamber is empty!**
3. Close the slide by gripping the rear of the slide with the thumb and index finger, pulling rearward and releasing the slide.

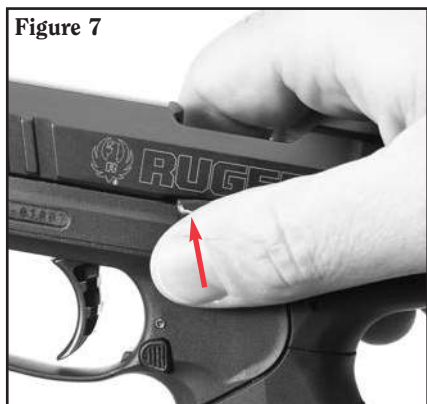

4. Rotate the takedown lever down until it is fully dropped. (See Figure 8.)
5. Grasp the rearward portion of the slide, pull it all the way to the rear, and lift upward. (See Figures 9a & 9b.)
6. Holding the rear of the slide upward, move the slide forward and remove it off the front end of the barrel. (See Figure 9b.)

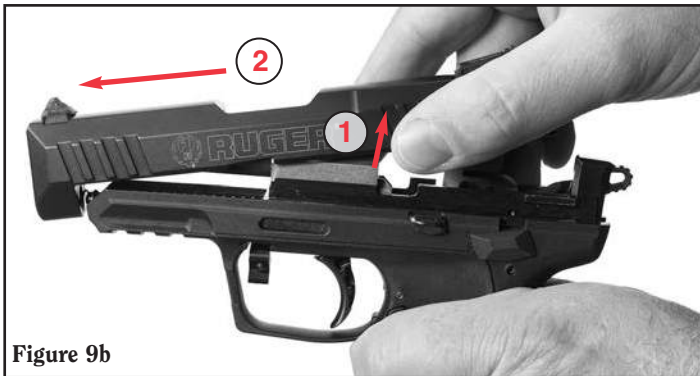

7. Remove the guide rod and recoil spring from the slide. (See Figure 10.)

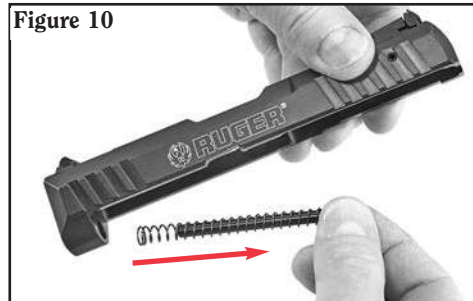



8. This completes normal field stripping for routine cleaning and lubrication purposes. (See Figure 11.) Further disassembly of the slide or frame components is not recommended and should only be undertaken by the factory.



 <b>WARNING - DISASSEMBLY</b>	
	<p>Always unload a firearm before cleaning, lubrication, disassembly or assembly.</p>
<p><b>UNLOAD BEFORE DISASSEMBLY</b></p>	

## REMOVING THE BARREL

The **RUGER® RUGER® SR22®** pistol barrel, although fixed, can be changed out.

**Be sure the pistol is unloaded.**

1. Disassemble to the field strip level as described on pages 23 - 25.
2. Using a 9/64" Allen wrench, loosen (but do not remove) the screw in front of the trigger until the barrel can be lifted off of the frame. (See Figure 12.)

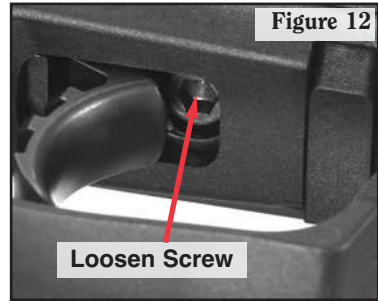

3. Remove the barrel from the frame by lifting upward. See Figure 13.

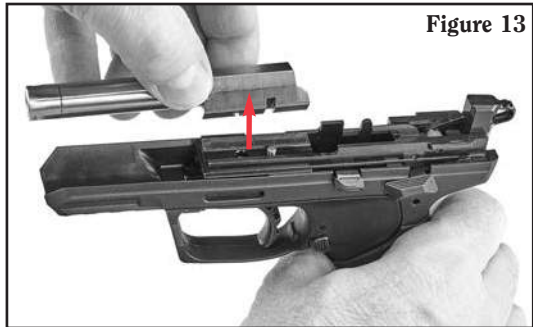

## REASSEMBLY

1. **Be certain chamber is empty and the magazine is removed from the firearm.**
2. To install the barrel, align the cut out in the bottom of the barrel with the barrel location pin (see Figure 14) and set the barrel onto the frame insert.





**Figure 15**

3. While holding the barrel in place, turn the barrel screw until you feel it make contact with the barrel. From this point, rotate the Allen wrench another 45 - 90 degrees to fully tighten the barrel screw. (See Figure 15.)

4. Verify that the takedown lever is rotated fully downward. (See Figure 16.)



**Figure 16**



**Figure 17**

5. Disengage the safety by pushing the safety lever up (red area exposed) and cock the hammer using your thumb. (See Figure 17.)

6. Install the recoil spring (small diameter end first as shown in Figure 18) onto the guide rod.

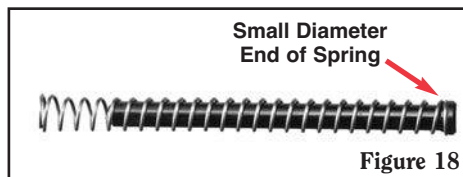

**Figure 18**

Insert the guide rod/recoil spring assembly into the hole in the frame insert. (See Figures 19a and 19b.) **NOTE:** Proper alignment shown in Figure 20.

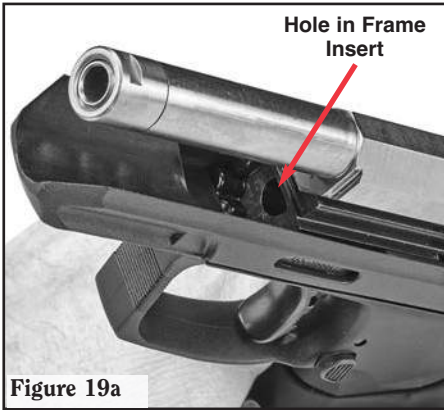

7. Line the recoil spring up with the hole in the chin of the slide. (See Figure 20.)



8. Keeping the rear of the slide pointed upward, move the slide completely rearward and down onto the frame. (See Figure 21.)



Note that light downward pressure will be required to depress the hammer slightly so that the slide can engage the frame rails. (See Figure 22.)



9. Guide the slide forward on the frame rails until it is completely closed. (See Figure 23.)

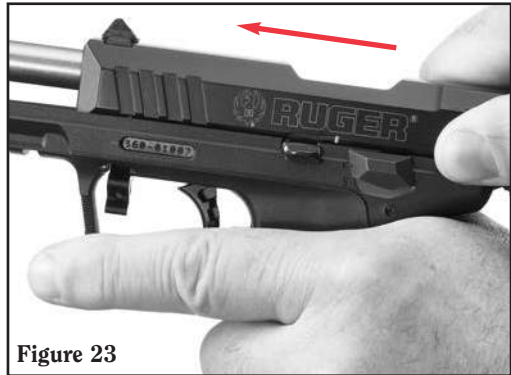

10. Rotate the takedown lever up until it snaps into place against the inside of the trigger guard. (See Figure 24.)
11. Point the pistol in a safe direction and engage the safety (red area covered) to decock the hammer.



## CHECK YOUR PISTOL'S FUNCTION

After any disassembly and reassembly, it is important to verify that the action is working correctly before any live firing is attempted.

**FIRST, BE SURE THERE IS NO AMMUNITION IN THE CHAMBER OR THE MAGAZINE AND KEEP THE PISTOL POINTED IN A SAFE DIRECTION!**

- a. CHECK THE FUNCTION OF THE SLIDE: With the safety in the “FIRE” position, magazine removed from the firearm, and the slide forward, pull the slide to the rear and let it move forward quickly two times.
  - The slide should move freely all the way to the rear and close completely under force of the recoil spring.
  - Insert an **EMPTY** magazine and pull the slide to the rear. Release the slide. The slide should be held open by the slide stop.
  - Remove the magazine. The slide should remain open.
  - Pull the slide fully to the rear and release it. The slide should move freely forward to its closed position and the hammer should remain cocked.
- b. CHECK THE FUNCTION OF THE MANUAL SAFETY AND MAGAZINE DISCONNECT: With the magazine removed from the pistol and the manual safety in the “FIRE” position, cycle the slide open and closed to ensure the hammer is in the cocked position.
  - Move the manual safety to “SAFE.” The hammer should fall into its decocked position.
  - Pull the slide fully to the rear and release it. The slide should close completely under force of the recoil spring and the hammer should fall to the decocked position as the slide closes.
  - Move the manual safety to “FIRE” and attempt to pull the trigger. The trigger should move rearward and not reset. The hammer should not move or otherwise fall.
  - Keeping the manual safety in the “FIRE” position, manually cock the hammer and attempt to pull the trigger. The trigger should move rearward slightly and the hammer should not fall.
  - Insert an **EMPTY** magazine into the pistol, keep the safety in the “FIRE” position, and ensure that the hammer is cocked. Attempt to pull the trigger. The hammer should fall.
  - Release the trigger fully, allowing it to reset. With the hammer down and the safety in the “FIRE” position, pull the trigger all the way to the rear. The pistol should function in double-action mode and the hammer should cock and fall.
  - Keeping the trigger pulled to the rear, cycle the slide to reset the hammer, pressing down on the slide stop to prevent the pistol from locking open. Slowly release the trigger. The trigger should move forward and you will hear/feel the trigger reset. The hammer should not fall, remaining in the cocked position.

- Move the manual safety to “SAFE.” The hammer should fall into its decocked position.
- Attempt to pull the trigger. The trigger should move rearward and reset to its forward position once released. The hammer should not move or otherwise fall.

If any of the above function checks fail or if you are uncertain, please consult a competent gunsmith or contact Ruger Customer Service at 336-949-5200 for further firearm inspection **before using the firearm.**

## INTERCHANGEABLE GRIP SLEEVES

**Make Sure Firearm Is Unloaded!**

The **RUGER® SR22®** pistol comes with two, interchangeable grip sleeves. **NOTE:** The detachable grip may initially be difficult to remove, but will break in over time. Once broken in, it will not become excessively loose

To change the grip sleeve, point the muzzle in a safe direction, remove the magazine by depressing the magazine release button, retract the slide and lock the slide open by pushing up on the slide stop lever. (See Figure 25.) Check to make sure the chamber is empty.



Figure 25

Hold the pistol as shown in the Figure 26 call-out, and grip the sleeve firmly in the other hand. **As you apply pressure to the front and rear of the grip sleeve, pull the sleeve down (see Figure 26) until it comes off.** **NOTE:** There are two detents that need to be overcome to remove the sleeve (see Figure 27, p. 32), so it will take some pulling force to remove the sleeve.

To install a grip sleeve, slip the sleeve over the bottom of the magazine well and slide upward on the frame until the detents snap into the sleeve. (See Figure 28, p. 32.)

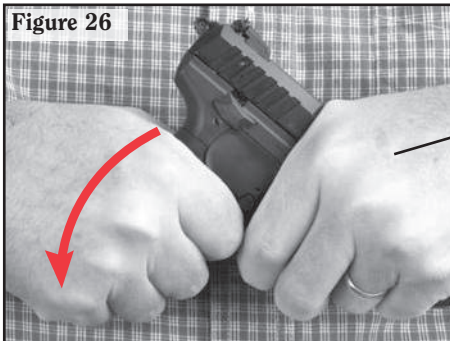

Figure 26



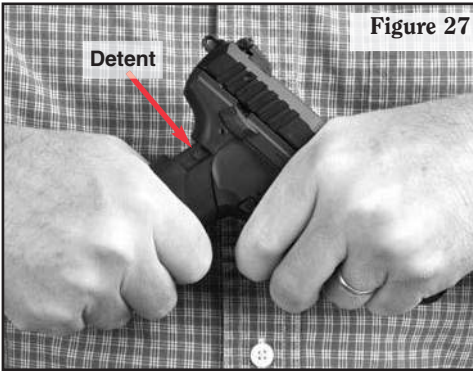

Figure 27



Figure 28

## SIGHT ADJUSTMENT

The **RUGER® SR22®** pistols are equipped with a rear sight which is adjustable for windage and elevation. To adjust the rear sight, move the sight in the direction you want the shot to move on the target (point of impact).

To move the group to the left, turn the windage screw clockwise using a slotted screwdriver. To move the group right, turn the windage screw counter-clockwise. (See Figure 29.)

To move the group down, turn the elevation screw clockwise using a slotted screwdriver. To move the group up, turn the elevation screw counter-clockwise. (See Figure 30.)

Both front and rear sights are provided with white-dot inserts for rapid target acquisition and easy alignment of the sights to obtain a correct sight picture.

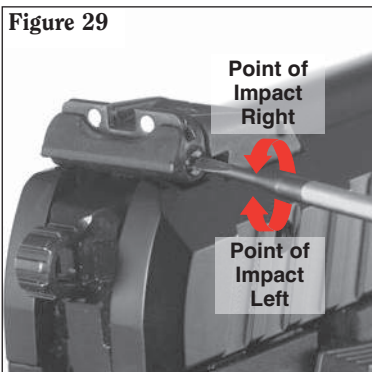

Figure 29

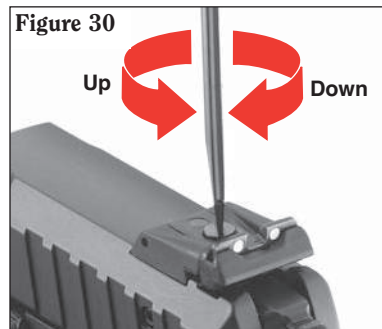

Figure 30



The rear sight blade can be reversed for a solid black rear sight if preferred.

1. To reverse the rear sight blade, first remove the windage screw.
2. Lift the sight blade up and out of the housing, rotate it to the desired sight, and reinstall it.
3. Be sure that the windage spring is compressed so that it pushes the sight blade to the left hand side of the pistol. A small punch installed through the windage screw hole makes this easier.
4. Reinstall the windage screw.

## ADAPTER/BARREL CAP REMOVAL AND INSTALLATION (ON PISTOLS SO EQUIPPED)

Some **RUGER® SR22™** pistols come equipped with a threaded barrel which is protected by a removable barrel cap. The cap protects the threads at the end of the barrel which are designed to accommodate a 22 Long Rifle sound suppressor.

To remove the barrel cap, keep your finger off the trigger, point the pistol in a safe direction, and remove the magazine. Using your non-shooting hand, retract the slide and lock it to the rear by pushing up on the slide release. Verify that the chamber is empty.

With the firearm pointed away from you and in a safe direction, use the supplied adapter/cap wrench to turn the barrel cap clockwise to loosen it. (See Figure 31.) Remove the cap from the barrel (see Figure 32) and store it in a safe place for reinstallation when the suppressor is removed.



Figure 31

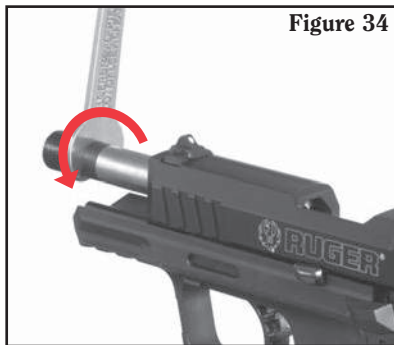

Figure 32



**WARNING: THE ADAPTER IS INTERNALLY THREADED COMPLETELY THROUGH THE ENTIRE BODY. IT IS IMPERATIVE THAT THE 1/2-28 EXTERNAL THREADS BE FACING AWAY FROM THE SLIDE. FAILURE TO DO THIS COULD RESULT IN DAMAGE TO THE SLIDE.**

Install the adapter by carefully screwing it onto the threaded portion of the barrel by hand. (See Figure 33.) Next, use the supplied adapter/cap wrench to hand-tighten the adapter firmly in place by turning it counter-clockwise with the pistol pointed away from you and in a safe direction. (See Figure 34.) **NOTE:** Do not use a cheater bar on the supplied adapter/cap wrench as damage can occur to either the adapter, cap or barrel.



With the adapter installed, hand-tighten the suppressor onto the adapter. The firearm is now ready to shoot.

We recommend using standard-velocity or subsonic ammunition with the suppressor installed. We do not recommend using hyper-velocity ammunition with the suppressor installed.

**NOTE:** The suppressor adapter must be removed before the slide can be removed from the firearm.

## MAGAZINE INSPECTION AND CARE

Check the magazine frequently. The magazine follower must move freely and have adequate tension so that each cartridge is quickly raised to the feeding position. The magazine lips should be clean and free of cracks, dents, or nicks, so that cartridges are held in their proper feeding position.

If the magazine becomes dirty, it should be disassembled and thoroughly cleaned. All **RUGER® SR22®** pistol magazines are manufactured with a snap-on base. The following disassembly instructions apply:

**Snap-On Base** - Use a punch to press in on the magazine spring seat where it protrudes into the hole in the magazine floorplate. Slide the magazine floorplate toward the front of the magazine, **be careful to prevent the forcible ejection of the magazine spring seat and compressed magazine spring.** Withdraw the magazine spring seat and magazine spring from the magazine body. Turn the magazine upside down and slide the magazine button to the bottom of the slot, and slide the button out of the magazine follower. The magazine follower can now be removed. Reassemble in reverse order. Be certain that the magazine follower and magazine button are reinstalled in the correct orientation.

The magazine button can be installed on either side of the magazine to suit the shooter's preference. To switch the magazine button, disassemble the magazine as described above. Reassemble the magazine installing the magazine button from the preferred side.

When cleaning is necessary, use a solvent that will not rust the metal components or adversely affect the magazine body. After the magazine has been soaked to loosen foreign matter, be certain to shake it vigorously (with the loading opening away from you) to remove solvent or residue from within the magazine. **Penetrating oils and solvents inside a magazine can "kill" or weaken cartridge primers or powder which can result in failures to fire or other possibly dangerous malfunctions, such as leaving a bullet in the bore!**

After cleaning, always check to be certain that the magazine follower movement and tension are correct, and that no solvent or debris remain. **Improper reassembly of the magazine can cause failure to feed, which is a potentially dangerous malfunction. If cleaning does not restore proper tension, or if you experience a problem with the magazine, don't use it. Get a new one.**

## CARE AND CLEANING

### Make Sure Firearm Is Unloaded!

**BEFORE CLEANING, BE CERTAIN THE PISTOL AND ITS MAGAZINE ARE UNLOADED.** (See “Warning - Unloading,” p. 19.)

At regular intervals, or whenever the pistol has been exposed to sand, dust, extreme humidity, condensation, immersion in water, or other adverse conditions, disassemble, clean, and oil it. Proper periodic maintenance is essential to the reliable functioning of any firearm.

An on-line video demonstrating the proper cleaning procedure of the **SR22®** pistol can be viewed by going to **Ruger.com/TechTips**. The proper cleaning procedure is discussed in the Disassembly/Reassembly video.

To clean the pistol, proceed as follows:

1. Disassemble (fieldstrip) the pistol to the extent described on pages 23 - 25.
2. Using a cleaning rod, run a properly sized, solvent-wetted patch through the bore several times. Then attach a solvent-wetted bristle brush to a cleaning rod and run it back and forth the full length of the bore as many times as necessary to remove grease and dirt from the bore and chamber. Clean bore with dry patches and examine. Bore fouling can contribute to reduced accuracy, and grease accumulation in the chamber can interfere with proper feeding of cartridges from the magazine.
3. Using powder solvent on a clean patch or bristle brush, remove powder residue from all components of the mechanism. After cleaning, run a dry patch through the bore, then follow with a patch that is very lightly oiled. Wipe all surfaces clean with cloth, then wipe all surfaces with a patch or cloth that has been very lightly oiled.
4. **NOTE:** Only a light application of oil is needed to provide adequate lubrication of moving parts and to prevent rust. Excess accumulations of oil tend to attract particles of dust and dirt and may congeal in cold weather, which can interfere with the safe and reliable function of the pistol.
5. Before firing, remove all oil and grease from the bore.

 <b>WARNING - LUBRICATION</b>	
	Firing a pistol with oil, grease, or any other material even partially obstructing the bore may result in damage to the pistol and serious injury to the shooter and those nearby. Do not spray or apply lubricants directly on ammunition. If the powder of a cartridge is affected by the lubricant, it may not be ignited, but the primer firing may push the bullet into the bore where it may be lodged. <b>Firing a subsequent bullet into the obstructed bore may damage the pistol and cause serious injury or death to the shooter and those nearby.</b> Use lubricants properly. You are responsible for the proper care and maintenance of your firearms.
<b>IMPROPER LUBRICATION DESTROYS FIREARMS</b>	

## STORAGE

**FIREARMS SHOULD NOT BE STORED LOADED!**

**USE THE LOCKING DEVICE SUPPLIED WITH THE PISTOL TO  
RENDER IT INOPERATIVE FOR SAFE STORAGE.**

**(SEE PAGE 9)**

***Do not*** keep your pistol in a leather, fabric or canvas holster when it is stored. These materials attract moisture, even though the holster may appear to be perfectly dry.

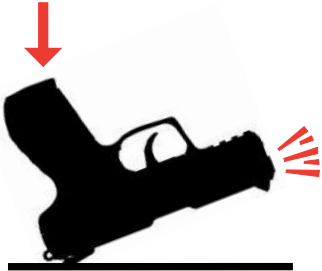
 <b>WARNING – STORAGE</b>	
	<ul style="list-style-type: none"><li>• Never place or store any firearm in such a manner that it may be dislodged. Firearms should always be stored securely and unloaded, away from children and careless adults.</li><li>• Use the locking device supplied with the pistol for storage. The use of a locking device or safety lock is only one aspect of responsible firearms storage.</li><li>• For increased safety, firearms should be stored unloaded in a location that is both separate from their ammunition and inaccessible to children and any other unauthorized person.</li></ul>
<b>STORE SECURELY &amp; UNLOADED</b>	

## SERVICE AND PARTS POLICY

If you have any questions with regard to the performance of your **RUGER® SR22®** pistol please contact our Customer Service online at **Ruger.com** or call the Customer Service Dept. at 336-949-5200. Fully describe all circumstances and conditions involved. If you should return your pistol to the factory for repair, or order parts for it, please comply with the following suggestions for prompt service:



**WARNING—BEFORE SHIPPING ANY FIREARM, BE ABSOLUTELY CERTAIN THAT IT AND ITS MAGAZINE ARE UNLOADED. DO NOT SHIP CARTRIDGES WITH A FIREARM.**

### SHIPPING FIREARMS FOR REPAIR:

**NOTE:** You must obtain a Repair Authorization Number before returning your firearm. An authorization number can be obtained by contacting Customer Service online at **Ruger.com** or calling the Customer Service Department at 336-949-5200. Firearms should be sent prepaid. We will not accept collect shipments. Any **RUGER® SR22®** pistol returned to the factory for repair should be sent to: Sturm, Ruger & Company, Inc., Customer Service Department, 271 Cardwell Road, Mayodan, NC 27027.

The Federal Gun Control Act, as well as the laws of most states and localities, do not prohibit an individual (who is not otherwise barred from purchasing or possessing a firearm) from shipping a firearm directly to the manufacturer for repair. However, before you ship your firearm to us, be certain that your state or locality does not have a law or regulation which will prohibit you from receiving the firearm (or any included magazines) from us after it has been repaired. If such receipt is prohibited, please have a federally licensed firearms dealer ship the firearm to us. If your firearm is sent to us by a dealer, it will be returned to that dealer after being repaired. If a handgun (pistol or revolver) is shipped by an individual who does not hold a Federal Firearms License, it must be shipped for overnight delivery via U.P.S., Federal Express, or other, similar private overnight service. **NOTE:** Handguns may not be shipped via U.S. Mail. Persons who do not hold a Federal Firearms License are prohibited by Federal law from shipping a handgun by Mail. Handguns mailed in violation of the law may be impounded or confiscated by the Post Office and the non-FFL may be subject to prosecution.

Please do not include holsters, custom grip panels, or accessories with a firearm being shipped to the factory for service. **DO NOT SEND FIREARM BOXES OR LITERATURE THAT YOU CONSIDER TO BE COLLECTOR'S ITEMS – THESE ARE INVARIABLY DAMAGED OR DESTROYED IN SHIPMENT.** Always insure your shipment.

Enclose a letter which includes your name, address, telephone number, firearm serial number and model, and your repair authorization number. Describe in detail the trouble you have experienced with your firearm, or the work you wish to have done. Merely stating that the firearm “needs repair” is inadequate information. Please enclose copies of any previous correspondence.

All work performed is subject to a minimum labor charge and charges for shipping and handling. Most models can be reblued, but custom gunsmithing service or nonstandard alterations are NOT AVAILABLE from Ruger Customer Service Departments. Please contact the Customer Service Department for pricing information. In states that have a magazine capacity limitation, **DO NOT RETURN** so-called “high capacity” magazines as Ruger may not be able to return the magazine to you.

 <b>WARNING – PARTS PURCHASERS</b>	
	<ul style="list-style-type: none"><li>• It is the purchaser’s responsibility to be absolutely certain that any parts ordered from the factory are correctly fitted and installed.</li><li>• Firearms are complicated mechanisms and <b>IMPROPER FITTING OF PARTS MAY RESULT IN A DANGEROUS MALFUNCTION, DAMAGE TO THE FIREARM, AND SERIOUS INJURY TO THE SHOOTER AND OTHER PERSONS.</b></li><li>• The purchaser and installer of parts must accept full responsibility for the correct adjustment and functioning of the firearm after such installation.</li></ul>
	<b>PARTS MUST FIT CORRECTLY</b>

### ORDERING PARTS

Please contact our Mayodan, North Carolina Customer Service Department for parts availability and current prices. All parts orders for the **RUGER® SR22®** pistol should be sent to: Sturm, Ruger & Company, Inc., Customer Service Department, 271 Cardwell Road, Mayodan, NC 27027, 336-949-5200. We cannot comply with open account or C.O.D. requests. Payment in full via credit card (Visa or MasterCard *only*), money order or certified bank check (no personal checks or cash, please) is required before any service will be performed. Please provide your credit card number, your name as it appears on the credit card, the expiration date, and the 3-digit security code. All parts orders are subject to a minimum charge and charges for shipping and handling. Order parts by **Part Name and specify the model and entire serial number** of the firearm for which the parts are being ordered. There is a minimum labor charge plus a shipping and handling charge if the parts are factory fit. All factory fit parts are fit on an exchange basis only. We will not return the replaced parts. Please contact the Customer Service Department for pricing information.

Because it is a serial numbered component, the **RUGER® SR22®** pistol frame is defined as a “firearm” by Federal law and is not sold as a separate component.

\*Parts designated by an asterisk must be factory fit. These parts are fit on an exchange basis only. We will not return the replaced parts. We will not return any part that is broken, malfunctioning, badly worn or has been modified. See “Warning - Parts Purchasers,” above.

	<b>WARNING: A firearm containing broken, malfunctioning or badly worn parts should not be fired!</b>
-------------------------------------------------------------------------------------	------------------------------------------------------------------------------------------------------

# RUGER® SR22® PISTOL

## PARTS LIST

Design, prices and specifications subject to change without notice.

**SPECIFY MODEL, CALIBER AND SERIAL NO. WHEN ORDERING**

(See Exploded View on Page 41)

Key No.	Part Name	Key No.	Part Name
	<b>Guide Rod Assembly - includes Key Nos. 1 - 2</b>		<b>Take Down Lever Assembly - includes Key Nos. 36 - 39</b>
1	Recoil Spring Guide	36	Take Down Lever
2	Recoil Spring	37	Take Down Lever Detent Plunger
	<b>Frame Insert Assembly - includes Key Nos. 3 - 31</b>	38	Take Down Lever Detent Spring
† 3	Frame Insert - Left Side	39	Take Down Lever Retaining Pin
* 4	Frame Insert - Right	40	Trigger Bar Spring
* 5	Hammer	41	Barrel Screw Lock Washer
* 6	Trigger		<b>Slide Assembly - includes Key Nos. 42 - 51</b>
* 7	Trigger Spring	42	Slide
* 8	Trigger Bar	43	Breech Block
* 9	Safety Assembly Forward Pin	44	Firing Pin Blocker
* 10	Safety Lever - Right Side	45	Blocker Spring
* 11	Safety Lever - Left Side	46	Extractor
* 12	Frame Insert Spacer	47	Firing Pin Spring
* 13	Single Action Sear Pivot Pin	48	Extractor Spring
* 14	Decock Hammer Stop	49	Firing Pin
* 15	Sear	50	Slide Cross Pin
* 16	Ejector	* 51	Dowel Pin for Slide Stop
* 17	Magazine Disconnect Spring		<b>Rear Sight Assembly - includes Key Nos. 52 - 59</b>
* 18	Magazine Disconnect	52	Rear Sight Base
* 19	Single Action Spring	53	Rear Sight Blade
* 20	Trigger Pivot Pin	54	Rear Sight Windage Spring
* 21	Hammer Spring Guide Stop	55	Rear Sight Elevation Spring
* 22	Hammer Spring - Inner	56	Rear Sight Windage Screw
* 23	Hammer Spring - Outer	57	Rear Sight Pivot Pin
* 24	Hammer Spring Guide	58	Rear Sight Arm
* 25	Barrel Location Pin	59	Rear Sight Elevation Screw
* 26	Blocker Lever	60	Front Sight
27	Take Down Lever Detent Pivot Pin		<b>Frame Assembly - includes Key Nos. 61 - 67</b>
28	Socket Cap Screw	61	Grip Frame
29	Socket Cap Screw	62	Grip - Small
* 30	Safety Detent	63	Grip Insert Pin
* 31	Safety Detent Spring	64	Magazine Latch
32	Trigger Bar Return Plunger	65	Magazine Latch Thumbpiece
33	Slide Stop Spring	66	Magazine Latch Spring
34	Slide Stop	67	Magazine Latch Pivot
35	Barrel	68	Barrel Screw
		69	Magazine Assembly

† The frame is a serial-numbered part and is not offered for sale.

\* PARTS SO MARKED MUST BE FACTORY FIT.



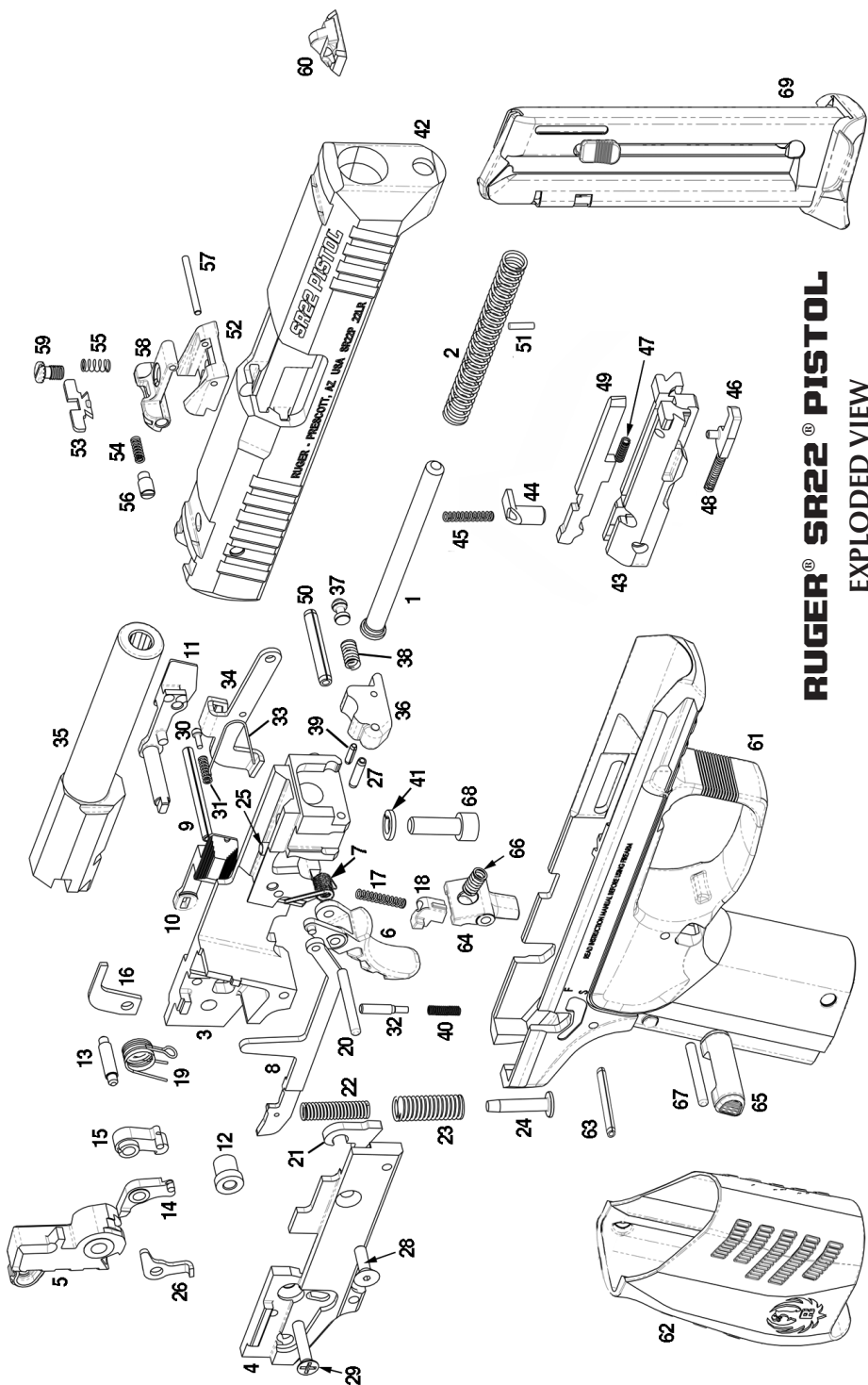

**RUGER® SR22® PISTOL**  
 EXPLODED VIEW

## THE BASIC RULES OF SAFE FIREARMS HANDLING

We believe that Americans have a right to purchase and use firearms for lawful purposes. The private ownership of firearms in America is traditional, but that ownership imposes the responsibility on the gun owner to use his firearms in a way which will ensure his own safety and that of others. When firearms are used in a safe and responsible manner, they are a great source of pleasure and satisfaction, and represent a fundamental part of our personal liberty.

Firearms do not cause accidents! Firearms accidents are almost always found to have been the result of carelessness or ignorance on the part of the shooter of the basic rules of safe gun handling.

The following rules must be observed by gun users at all times. Safe gun handling is not just desirable, it is absolutely essential to your safety, the safety of others, and the continuation of gun ownership and sport shooting as we know it today.

### 1. LEARN THE MECHANICAL AND HANDLING CHARACTERISTICS OF THE FIREARM YOU ARE USING.



Not all firearms are the same. The method of carrying and handling firearms varies in accordance with the mechanical provisions for avoiding accidental discharge and the various proper procedures for loading and unloading. No person should handle any firearm without first having thoroughly familiarized himself with the particular type of firearms he is using, and with safe gun handling in general.

### 2. ALWAYS KEEP THE MUZZLE POINTED IN A SAFE DIRECTION.



Be sure of the bullet stop behind your target, even when dry-firing. Never let the muzzle of a firearm point at any part of your body or at another person. This is particularly important when loading or unloading a firearm. In the event of an accidental discharge, no injury can occur as long as the muzzle is pointing in safe direction. A safe direction means a direction that will not permit a discharged bullet to strike a person, or to strike an object from which the bullet may ricochet.

A safe direction must take into account the fact that a bullet may penetrate a wall, ceiling, floor, window, etc., and strike a person or damage property. Make it a habit to know exactly where the muzzle of your gun is pointing whenever you handle it, and be sure that you are always in control of the direction in which the muzzle is pointing, even if you fall or stumble. Keep your finger off the trigger until you are ready to shoot.

### 3. FIREARMS SHOULD BE UNLOADED WHEN NOT IN USE.

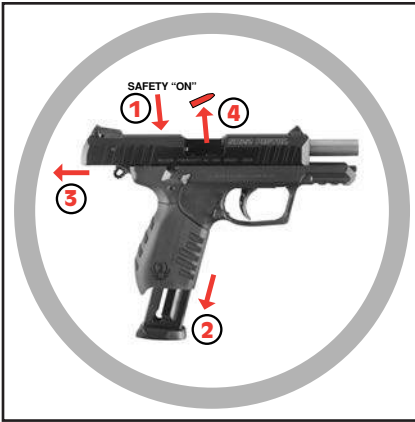

Firearms should be loaded only when you are in the field or on the target range or shooting area, ready to shoot. Firearms and ammunition should be securely locked in safes, racks or cabinets, or by using the locking device supplied with the firearm when not in use. Ammunition should be safely stored separate from firearms. Store your firearms out of sight of visitors and children. It is the gun owner's responsibility to be certain that children and persons unfamiliar with firearms cannot gain access to firearms, ammunition, or components.

### 4. BE SURE THE BARREL IS CLEAR OF OBSTRUCTIONS BEFORE SHOOTING.

Even a bit of mud, snow or excess lubricating oil or grease in the bore may cause the barrel to bulge, or even burst on firing, and can cause injury to the shooter and bystanders. Be sure that you are using ammunition of the proper caliber and loading for the gun you are using. If the report or recoil on firing seems weak, or doesn't seem quite right, **CEASE FIRING IMMEDIATELY**, unload your firearm, and check to be sure that no obstruction has become lodged in the barrel. Never try to shoot an obstruction out!





## 5. BE SURE OF YOUR TARGET BEFORE YOU SHOOT.

Don't shoot unless you know exactly where your bullet is going to strike. Be sure of the bullet stop behind your target, even when dry-firing with an unloaded gun. If you are in the field hunting, do not fire at a movement or noise. Take the time to be absolutely certain of your target before you pull the trigger.

## 6. WEAR SHOOTING GLASSES AND HEARING PROTECTION WHEN YOU SHOOT.

All shooters should wear protective shooting glasses and adequate hearing protection when shooting. Exposure to shooting noise can damage hearing, and wearing adequate eye protection when shooting is essential.

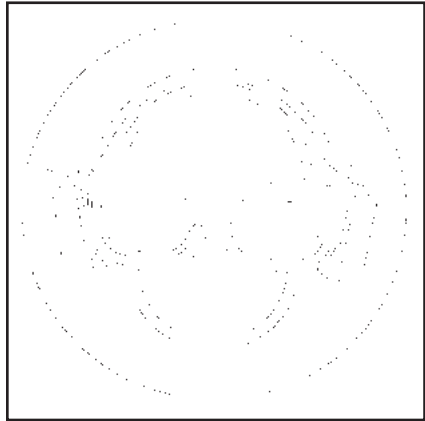

## 7. NEVER CLIMB A TREE OR FENCE WITH A LOADED FIREARM.

Put the firearm down carefully before climbing a fence, and unload it before climbing or descending a tree or jumping over a ditch or other obstruction. Never pull or push a loaded firearm toward yourself or another person. When in doubt, or whenever you are about to do anything awkward, unload your gun!

**8. DON'T SHOOT AT A HARD SURFACE OR AT WATER.**

Bullets can glance off many surfaces like rocks or the surface of water and travel in unpredictable directions with considerable velocity.



**9. NEVER TRANSPORT A LOADED FIREARM.**

Firearms should always be unloaded before being moved or placed in a vehicle. A suitable carrying case or scabbard should be used to carry an unloaded firearm to and from the shooting area.

**10. AVOID ALCOHOLIC BEVERAGES WHEN SHOOTING.**

Don't drink until the day's shooting is over. Handling firearms while under the influence of alcohol in any form, or medications that could affect your judgement or coordination, constitutes a criminal disregard for the safety of others.



## A BRIEF ACCOUNT OF AN EXTRAORDINARY ACHIEVEMENT: RUGER® FIREARMS

Sturm, Ruger & Company, Inc., had its beginning in a small machine shop occupying a rented frame building in Southport, Connecticut. In January, 1949, with an initial investment of only \$50,000 and an idea, William B. Ruger and Alexander M. Sturm started production of a .22 caliber autoloading pistol—a design which was so successful that it became the cornerstone upon which one of the most comprehensive lines of sporting firearms ever made in America was established. After Alex Sturm's death in 1951, William B. Ruger continued to direct the Company until his death in 2002. William B. Ruger, Jr. continued to provide guidance, which helped make this Company a sound and successful enterprise, until his retirement in 2006. The Company has continued to prosper, under new management and guidance from our Board, with new products and fresh perspectives.

Ruger, in this relatively short time, has established itself as a leading small arms design organization, developing a unique and broad line of fine quality sporting, military and police firearms to become one of the world's most famous producers of revolvers, pistols, rifles and shotguns. Since 1949, Ruger craftsmen have built many millions of firearms.

During its five decades of growth and progress under the leadership of William B. Ruger, the Company developed a business philosophy and implemented policies which represent a constructive influence in the life of modern America. From the beginning, Ruger played a positive role in conservation efforts and has supported the interests of shooters through such groups as the National Rifle Association, National Shooting Sports Foundation, and many regional sportsmen's organizations.

The Company has always endeavored to market its firearms for constructive and recreational purposes, to emphasize the traditional and responsible aspects of shooting, to render meaningful public services, and to encourage shooters in constructive, responsible, and safe participation in the shooting sports. Its motto, "Arms Makers For Responsible Citizens®," exemplifies this Company philosophy.

Today, Ruger® is particularly mindful of those elements which have contributed to the creation of its success, and extends heartfelt thanks to its many loyal employees and customers.

The firearms catalog, and instruction manuals for all Ruger® firearms, can be downloaded from our website at:

**Ruger.com**

# NOTES

## WHY NO WARRANTY CARD HAS BEEN PACKED WITH THIS NEW RUGER® FIREARM

The Magnuson-Moss Act (Public Law 93-637) does not require any seller or manufacturer of a consumer product to give a written warranty. It does provide that if a written warranty is given, it must be designated as “limited” or as “full” and sets minimum standards for a “full” warranty. Sturm, Ruger & Company, Inc. has elected not to provide any written warranty, either “limited” or “full”, rather than to attempt to comply with the provisions of the Magnuson-Moss Act and the regulations issued thereunder. There are certain implied warranties under state law with respect to sales of consumer goods. As the extent and interpretation of these implied warranties varies from state to state, you should refer to your state statutes. Sturm, Ruger & Company wishes to assure its customers of its continued interest in providing service to owners of Ruger® firearms.



**STURM, RUGER & COMPANY, INC.**  
271 Cardwell Road  
Mayodan, North Carolina 27027 U.S.A.  
**Ruger.com**

**Arms Makers For Responsible Citizens®**

**A COPY OF THE INSTRUCTION MANUAL FOR ANY RUGER®  
FIREARM IS AVAILABLE FROM THE FACTORY FREE ON REQUEST, OR IT MAY BE  
DOWNLOADED FROM OUR WEBSITE AT RUGER.COM.  
THESE INSTRUCTION MANUALS CONTAIN IMPORTANT  
WARNINGS WHICH MUST BE UNDERSTOOD  
BEFORE USING THESE FIREARMS.**

**The Following are Sturm, Ruger & Co., Inc. Trademarks:** “BX-Trigger,” “Bisley,” Eagle Hard “R” logo holding gun, “Elite 452,” “Gold Label,” “I’m a Ruger American,” “LC6,” “LCR-357,” “LC380CA,” “Mark II,” “Mark III,” “Model 96,” “P345,” “P345D,” “P345PR,” “P85,” “P90,” “P91,” “P93,” “P94,” “P95,” “P97,” “R.I.O.S.,” “Ruger-57,” “Ruger Marksman Adjustable,” “Ruger 77/50,” “Ruger 10/17,” “Ruger Titanium,” “Security-Six,” “Service-Six,” “77/357,” “Single-Seven,” “Speed-Six,” “SR45,” “SR-556C,” “SR-556VT,” “SR-762,” “Super Bearcat,” “Target Grey,” “10/22-FS,” “This is Ruger. This is America,” “Tri-Flex,” “22 Charger,” “22/45,” and “22/45 RP.”

**The Following are Registered U.S. Trademarks Belonging to Sturm, Ruger & Co., Inc.:** “AC-556,” “AR-556,” “Arms Makers For Responsible Citizens,” “All-Weather,” “Bearcat,” “Blackhawk,” “BX-15,” “BX-25,” Eagle ‘R’ - soft ‘R’ & hard ‘R,’ Eagle ‘SR,’ “EC9s,” “Everything you need and nothing you don’t,” “GP100,” “Hawkeye,” “It’s Mine and It’s American,” “It’s Mine. And It’s American,” “LC380,” “LC9,” “LC9s,” “LC9s Pro,” “LCP,” “LCR,” “LCRx,” “M77,” “Match Champion,” “Mini Thirty,” “Mini-14,” “9E,” “Old Army,” “Power Bedding,” “Redhawk,” “RUGER,” “Ruger American Pistol,” “Ruger American Pistol” flag design, “Ruger American,” “Ruger American Rifle,” “Ruger American Rimfire,” “Ruger Custom Shop,” “Ruger Hunting” - phrase & logo design, “Ruger Inside & Out” - phrase & logo design, “Ruger Precision,” “Ruger Precision Rifle,” “Ruger 77/17,” “Ruger 77/22,” “Ruger 77/44,” “Ruger SP101,” “Ruger 10/22 Takedown” phrase & logo design, “Ruger 22/45 Lite,” “Ruger Vaquero,” “Rugged, Reliable Firearms,” “Security-9,” “Silent-SR,” “Single-Nine,” “Single-Six,” “Single-Ten,” the “SR” Design, “SR9,” “SR9c,” “SR40,” “SR40c,” “SR-22,” “SR22,” “SR-556,” “SR-556 Takedown,” “SR1911,” “Super Redhawk Alaskan,” “10/22,” “10/22 Takedown,” and “Wrangler.”