



# Smith & Wesson®

---

## Safety & Instruction Manual For SD9™, SD40™ and SD9 VE™, SD40 VE™ PISTOLS

---



**Read the instructions and  
warnings in this manual  
CAREFULLY BEFORE  
using this firearm.**

2100 Roosevelt Avenue • Springfield, MA 01104  
1-800-331-0852 • Fax: 413-747-3317  
[www.smith-wesson.com](http://www.smith-wesson.com)

Copyright © 2021 Smith & Wesson Inc.  
All rights reserved.



**WARNING:**  
**READ THESE INSTRUCTIONS  
AND WARNINGS CAREFULLY.  
BE SURE YOU UNDERSTAND  
THESE INSTRUCTIONS AND  
WARNINGS BEFORE USING THIS  
FIREARM. FAILURE TO READ THESE  
INSTRUCTIONS AND TO FOLLOW THESE  
WARNINGS MAY RESULT  
IN SERIOUS INJURY OR DEATH TO  
YOU AND OTHERS AND  
DAMAGE TO PROPERTY.**



**THIS SAFETY & INSTRUCTION  
MANUAL SHOULD ALWAYS  
ACCOMPANY THIS FIREARM AND BE  
TRANSFERRED WITH IT UPON CHANGE  
OF OWNERSHIP OR WHEN PRESENTED TO  
ANOTHER PERSON. A COPY OF THE  
SAFETY & INSTRUCTION MANUAL IS  
AVAILABLE FREE VIA DOWNLOAD AT  
[www.smith-wesson.com](http://www.smith-wesson.com)  
OR UPON REQUEST FROM:**

**SMITH & WESSON®  
CUSTOMER SUPPORT CENTER  
2100 ROOSEVELT AVENUE  
SPRINGFIELD, MA 01104  
TEL.: 1-800-331-0852, ext. 4125  
E-mail: [qa@smith-wesson.com](mailto:qa@smith-wesson.com)**

## TABLE OF CONTENTS

YOUR SAFETY RESPONSIBILITIES .....	3-6
SAFE STORAGE AND TRANSPORTATION.....	7-8
AMMUNITION .....	9-11
MODEL AND FEATURES IDENTIFICATION .....	12
INSPECTING YOUR PISTOL .....	13-14
LOADED CHAMBER INDICATOR .....	15
PREPARATION FOR FIRING.....	16-17
LOADING.....	17-19
FIRING .....	20-21
HANGFIRES AND MISFIRES.....	21-23
CLEARING A MISFEED/JAM .....	23-24
UNLOADING .....	24-25
FIELD STRIPPING / DISASSEMBLY .....	25-30
LUBRICATION .....	31
ASSEMBLY .....	32-33
SIGHT ADJUSTMENT .....	34
MAGAZINE .....	35
MAGAZINE SAFETY (If pistol is so-equipped) .....	36-37
CLEANING AND MAINTENANCE .....	37-39
LIMITED WARRANTY .....	40-41
CONTACT AND SHIPPING FOR SERVICE .....	42-43
CUSTOM SERVICE.....	44
PATENT INFORMATION, INTERNATIONAL WARRANTY CENTERS.....	45
BATTERY WARNINGS.....	47

## YOUR SAFETY RESPONSIBILITIES

### SAFETY IS YOUR NUMBER ONE RESPONSIBILITY!

- At home, in the field, at the range, or anywhere, the first concern of every firearm owner should be safety. Apply the following safety rules in every situation, with any kind of firearm. If you feel uncertain about any operational aspects of your firearm, please contact Smith & Wesson® at 1-800-331-0852, ext. 4125 before proceeding with its operation.
- If you are unfamiliar with firearms you should seek formal training before using your pistol.



**WARNING: YOU MUST FOLLOW ALL OF THESE SAFETY RULES TO ENSURE THE SAFE USE OF YOUR FIREARM. THE FAILURE TO FOLLOW THE INSTRUCTIONS AND WARNINGS IN THIS MANUAL COULD CAUSE SERIOUS PERSONAL INJURY OR DEATH TO YOU OR OTHERS AND DAMAGE TO PROPERTY.**

- As a firearm owner, you accept a demanding responsibility. How seriously you take this responsibility can be the difference between life and death. There is no excuse for careless or abusive handling of your firearm. At all times handle your firearm with intense respect for its power and potential danger.



---

## YOUR SAFETY RESPONSIBILITIES CONTINUED

---

- **ALWAYS KEEP YOUR FIREARM POINTED IN A SAFE DIRECTION.** Never point a firearm at anyone or anything you do not intend to shoot whether or not it is loaded. This is particularly important when loading, unloading, or field stripping the gun. ALWAYS control the direction of the firearm.
- **ALWAYS TREAT EVERY FIREARM AS IF IT IS LOADED AND WILL FIRE.** Do not take anyone's word that the firearm is unloaded – always check for yourself. Never pass your firearm to another person until the cylinder or action is open and you visually check that it is unloaded. Keep your firearm unloaded and safely stored when not in use.
- **NEVER PLACE YOUR FINGER INSIDE THE TRIGGER GUARD OR ON THE TRIGGER UNLESS YOU INTEND TO FIRE.** Ensure that other objects do not touch the trigger.
- **ALWAYS BE SURE OF YOUR TARGET AND WHAT IS BEYOND IT.** Always be sure of where the bullet will strike and shoot only where there is a safe back stop free of obstructions, water or other surfaces which can cause ricochets. Be sure your bullet will stop behind your target. Bullets can glance off many surfaces like rocks or the surface of water and travel in unpredictable directions with considerable velocity. Do not fire randomly into the sky.
- **NEVER CROSS OBSTACLES SUCH AS FENCES OR STREAMS WITH A LOADED FIREARM.** Always make certain your firearm is unloaded before crossing a fence, climbing a tree, jumping a ditch or negotiating other obstacles.
- **SAFE GUN HANDLING IS YOUR PERSONAL RESPONSIBILITY AT ALL TIMES.** Firearms are dangerous and can cause serious injury or death if they are misused or used inappropriately. Safety must be the prime consideration of anyone who owns or handles firearms. Accidents are the result of violating the rules of safe gun handling and common sense. Firearm safety training is available. Contact your firearms dealer, law enforcement agency, local sportsman's club, etc. for availability.
- **YOU ARE RESPONSIBLE FOR THE FIREARM AT ALL TIMES.** In owning a firearm, you must undertake full-time responsibility for making sure your firearm is safe and secure at all times. You must protect yourself and all others against injury or death from misuse of the firearm 24 hours a day.
- **FIREARM SECURITY IS YOUR RESPONSIBILITY.** You must secure firearms safely from children and/or unauthorized users. Your firearm should always be kept unloaded and locked when not in use. A lock has been provided for this purpose. Never assume that the use of this lock is sufficient to safely secure your firearm. You must always evaluate your personal situation and employ the security systems that meet your needs and prevent children and unauthorized users from gaining access to your firearm.



---

## YOUR SAFETY RESPONSIBILITIES CONTINUED

---

- **APPROPRIATE USE OF YOUR FIREARM MEANS USING YOUR FIREARM FOR LEGAL PURPOSES.** For example - target shooting, hunting and lawful resistance of deadly criminal force. It is your responsibility to ensure that you are in compliance with all applicable laws and ordinances regarding the use of your firearm.
- **NEVER RELY ON MECHANICAL FEATURES ALONE.** Only your safe gun-handling habits will ensure the safe use of your firearm. This is your responsibility.
- **ALWAYS SAFELY STORE AND SECURE YOUR FIREARM.** Safe and secure storage of your firearm is one of your most important responsibilities. It is a full-time responsibility. You must always secure your firearm and ammunition separately so that they are not accessible to children and/or other unauthorized persons.
- **NEVER KEEP AMMUNITION IN THE SAME LOCATION AS THE FIREARM.** Store each in a separate and secure place.
- **ALWAYS WEAR EYE PROTECTION THAT IS SPECIFIED FOR USE WITH FIREARMS** every time you handle your firearm for cleaning and maintenance.
- **ALWAYS WEAR EYE AND HEARING PROTECTION THAT ARE SPECIFIED FOR USE WITH FIREARMS** every time you discharge your firearm. Make sure others in the vicinity of where you will be shooting do so as well.
- **NEVER USE ALCOHOL OR DRUGS BEFORE OR WHILE SHOOTING.** Do not use your firearm if you are on any medication which impairs, even slightly, your mental or physical ability.
- **ALWAYS HAVE ADEQUATE VENTILATION.** Discharging firearms in poorly ventilated areas, cleaning firearms, or handling ammunition may result in exposure to lead and other substances known to cause birth defects, reproductive harm, and other serious physical injury. Review the warnings and labels for all ammunition and cleaning products carefully. Wash hands thoroughly after exposure.
- **BEFORE HANDLING ANY FIREARM, UNDERSTAND ITS OPERATION.** Not all firearms are the same. Familiarize yourself with the mechanical features of any firearm you intend to use. If you feel uncertain about any operational aspects of your firearm, please contact Smith & Wesson® at 1-800-331-0852, ext. 4125 before proceeding with its operation.
- **NEVER ALLOW A FIREARM TO BE USED BY INDIVIDUALS WHO DO NOT UNDERSTAND ITS SAFE OPERATION OR HAVE NOT READ THESE FIREARM SAFETY RULES.**

## YOUR SAFETY RESPONSIBILITIES CONTINUED

- **ALWAYS USE THE CORRECT AMMUNITION FOR YOUR PARTICULAR FIREARM** as indicated by the marking on the barrel. Never use non-standard, reloaded, or “handloaded” ammunition which has not been subjected to internal ballistic pressure testing.
- **BEWARE OF BARREL OBSTRUCTIONS** Be sure the barrel is clear of obstructions before shooting. Mud, water, snow or other objects may inadvertently lodge in the barrel bore. A small obstruction can cause a dangerous increase in pressure and may damage your gun and cause injury to yourself and others.
- **BE SURE ALL ACCESSORIES, SUCH AS HOLSTERS, GRIPS, SLINGS, SCOPES AND OTHER ACCESSORIES ARE COMPATIBLE** with the firearm and that the accessories do not interfere with safe operation. It is your responsibility to understand and follow all of the instructions in this manual, as well as those which may be supplied with your ammunition and any accessory.
- **NEVER DISASSEMBLE YOUR FIREARM BEYOND THE FIELD STRIPPING PROCEDURE** outlined in this manual. Improper disassembly or reassembly of your firearm may be dangerous and can lead to serious injury or death.
- **NEVER MANIPULATE, ADJUST OR CHANGE ANY OF THE INTERNAL COMPONENTS OF YOUR FIREARM UNLESS SPECIFICALLY INSTRUCTED TO DO SO IN THIS MANUAL.** Improper manipulation of any other internal component may affect the safety and reliability of your firearm and may cause serious injury or death.
- **NEVER ALLOW ANY ALTERATION OR REPLACEMENT OF PARTS IN YOUR SMITH & WESSON FIREARM UNLESS PERFORMED BY A QUALIFIED GUNSMITH** using genuine Smith & Wesson® parts. If you do otherwise, improper functioning of your firearm may occur and serious injury or death and damage to property may result.



**WARNING: SAFE USE OF A FIREARM IS YOUR PERSONAL RESPONSIBILITY AND THE FAILURE TO FOLLOW ALL OF THESE BASIC SAFETY RULES MAY RESULT IN SEVERE PERSONAL INJURY OR DEATH TO YOU OR OTHERS AND DAMAGE TO PROPERTY. YOU ARE THE MOST IMPORTANT SAFETY DEVICE WHEN IT COMES TO THE USE OF YOUR FIREARM AND SMITH & WESSON® WILL NOT BE RESPONSIBLE FOR ANY PERSONAL INJURY, DEATH OR PROPERTY DAMAGE THAT RESULTS FROM: (1) THE CRIMINAL OR NEGLIGENT USE OF THIS FIREARM; (2) A DISREGARD OF THESE SAFETY INSTRUCTIONS AND WARNINGS; (3) IMPROPER OR CARELESS HANDLING OF THIS FIREARM; (4) THE USE OF NON-STANDARD, DEFECTIVE, OR IMPROPER AMMUNITION; (5) OR, IMPROPER OR NEGLIGENT MODIFICATIONS OR REPAIRS TO THE FIREARM.**

# SAFE STORAGE AND TRANSPORTATION



**WARNING: ALWAYS KEEP THE MUZZLE POINTED IN A SAFE DIRECTION.**



**WARNING: FIREARMS ARE DANGEROUS WHEN USED AND STORED IMPROPERLY. THEY POSE A RISK OF SERIOUS OR FATAL INJURIES. FIREARMS CAN BE ESPECIALLY DANGEROUS TO CHILDREN WHEN THEY ARE STORED IN AN IRRESPONSIBLE AND UNSAFE MANNER. FOR YOUR SAFETY AND THE SAFETY OF OTHERS, IT IS IMPERATIVE THAT YOU KEEP YOUR FIREARM LOCKED AND UNLOADED IN A SECURE PLACE. THE AMMUNITION SHOULD BE STORED IN A SEPARATE, SECURE LOCATION WHEN IT IS NOT IN USE. SAFE AND SECURE STORAGE OF YOUR FIREARM IS ONE OF THE MOST IMPORTANT RULES OF FIREARM SAFETY. YOUR FAILURE TO FOLLOW THESE RULES MAY RESULT IN SERIOUS INJURY OR DEATH TO YOU OR OTHERS.**

- **ALWAYS SECURE YOUR FIREARM IN A MANNER THAT WILL PREVENT UNAUTHORIZED ACCESS.** Whenever your firearm is not in use, keep it unloaded and locked. Your safety and the safety of others requires that you always secure and store your firearm in a manner that will prevent unauthorized access. Never leave a firearm unattended unless it is locked, unloaded and secured.
- **ALWAYS USE THE LOCK PROVIDED BY SMITH & WESSON TO SECURE YOUR FIREARM.** Please read and follow the instructions packaged separately for the use of this lock. A lock, when properly used, can be an effective tool in preventing unauthorized access to your firearm. There are other alternative locks and safe storage containers available in the marketplace which may also be appropriate for your particular needs. Consult your local gun shop, hardware store, or local police department for guidance on the variety of other safe storage devices or practices which may be appropriate for your particular needs. By purchasing this firearm you have accepted the responsibility of safely securing the firearm at all times and preventing its unauthorized use. Never assume that the use of this lock alone is sufficient to safely secure your firearm. It is your personal responsibility to select and use whatever measures or practices that will enable you to be absolutely certain that your firearm is secure at all times.



**WARNING: NEVER LOCK A LOADED FIREARM AND NEVER LOAD A LOCKED FIREARM!**

- **ALWAYS STORE YOUR FIREARM AND AMMUNITION SEPARATELY** so that they are not accessible to children or other unauthorized persons. Safe and secure storage of your firearm and ammunition are your responsibility. It is a full-time responsibility.



---

## SAFE STORAGE AND TRANSPORTATION CONTINUED

---

- **NEVER ASSUME THAT A “HIDING” PLACE IS A SECURE STORAGE METHOD.** Others may be aware of your storage location or come upon it by chance. It is your personal responsibility to use common sense when storing your firearm and ammunition and to always make sure they are not accessible to children or other unauthorized persons.
- **NEVER TRANSPORT A LOADED FIREARM.** When transporting your firearm, be sure it is unloaded and locked. Safe and secure transportation of your firearm is your responsibility.
- **ALWAYS FOLLOW THE LAW!** Many jurisdictions have laws that make it a crime to keep a firearm unlocked and in an area accessible to children or others. Keeping a firearm locked and unloaded when not in use is not only common sense safety practice... IT IS THE LAW. You must be familiar with all local, state, and federal laws regarding the safe storage and transportation of your firearm. Failure to know and follow the law may result in unauthorized access or use of your firearm by another. Obey all laws relating to the storage and transportation of firearms. Your local police department or gun shop can furnish you with available information on storing and/or transporting a firearm safely and legally.
- **YOUR FIREARM IS YOUR RESPONSIBILITY.** You must prevent your firearm from being stolen or from being used by untrained or unqualified individuals. Keep it locked, unloaded and secured when not in use.



# AMMUNITION



**WARNING: NEVER USE AMMUNITION NOT SPECIFICALLY DESIGNATED FOR USE IN YOUR FIREARM. FAILURE TO USE THE CORRECT TYPE OR CALIBER OF AMMUNITION MAY CAUSE THE FIREARM TO JAM, OR FAIL TO FIRE, OR MAY GENERATE EXCESSIVE PRESSURE WHICH CAN DAMAGE OR EVEN RUPTURE YOUR FIREARM, CAUSING PERSONAL INJURY OR DEATH TO THE SHOOTER OR BYSTANDERS.**

- Locate the cartridge designation marked on the firearm. This information indicates the correct ammunition that must be used in this firearm (FIGURE 1).
- You are responsible for selecting ammunition that meets industry standards and is appropriate in type and caliber for this firearm.
- Never mix ammunition.

FIGURE 1



**WARNING: IN SOME CASES, A ROUND OF AMMUNITION NOT SPECIFIED ON YOUR FIREARM AND NOT LISTED AS ALTERNATE AMMUNITION IN THIS MANUAL, MAY FIT INTO THE CHAMBER. FIRING THIS AMMUNITION MAY CAUSE A RUPTURE RESULTING IN DAMAGE TO THE FIREARM AND PERSONAL INJURY OR DEATH TO THE SHOOTER OR BYSTANDERS. FOR MORE INFORMATION REGARDING UNSAFE CALIBER COMBINATIONS, REFER TO THE FOLLOWING URL: [HTTPS://SAAMI.ORG/WP-CONTENT/UPLOADS/2021/10/SAAMI-GENERALLY-ACCEPTED-FIREARMS-AND-AMMUNITION-INTERCHANGEABILITY-10-8-2021.PDF](https://saami.org/wp-content/uploads/2021/10/saami-generally-accepted-firearms-and-ammunition-interchangeability-10-8-2021.pdf)**



**WARNING: ALWAYS INSPECT YOUR AMMUNITION BEFORE USING IT. NEVER USE DIRTY, CORRODED OR DAMAGED AMMUNITION. A BURST CARTRIDGE MAY RESULT CAUSING DAMAGE TO THE FIREARM AND PERSONAL INJURY OR DEATH TO THE SHOOTER OR BYSTANDERS.**

- Use only commercially manufactured ammunition with internal ballistic pressures which are in strict accordance with the specifications of the Sporting Arms and Ammunition Manufacturers' Institute (SAAMI). If you are uncertain, contact your ammunition supplier for verification.



**WARNING: DISCHARGING FIREARMS IN POORLY VENTILATED AREAS, CLEANING FIREARMS, OR HANDLING AMMUNITION MAY RESULT IN EXPOSURE TO LEAD AND OTHER SUBSTANCES KNOWN TO CAUSE BIRTH DEFECTS, REPRODUCTIVE HARM, AND OTHER SERIOUS PHYSICAL INJURY. HAVE ADEQUATE VENTILATION AT ALL TIMES. WASH HANDS THOROUGHLY AFTER EXPOSURE.**

## AMMUNITION CONTINUED



**WARNING: NEVER USE NON-STANDARD, RELOADED OR “HANDLOADED” AMMUNITION WHICH HAS NOT BEEN SUBJECTED TO INTERNAL BALLISTIC PRESSURE TESTING. RELOADED OR HANDLOADED AMMUNITION, MAY HAVE MANY MANUFACTURING AND QUALITY VARIABLES (SUCH AS THE TYPE AND AMOUNT OF GUN POWDER). CARTRIDGE CASES THAT HAVE BEEN RELOADED AND FIRED MULTIPLE TIMES MAY SUFFER PHYSICAL DAMAGE WHICH COULD SIGNIFICANTLY IMPACT OR REDUCE THE INTEGRITY OF THE CARTRIDGE, POSSIBLY RESULTING IN BULLET SETBACK OR UNSEATING. CASE FAILURE AND INJURY TO THE SHOOTER OR BYSTANDERS AND DAMAGE TO THE FIREARM MAY RESULT WHEN SUCH A ROUND IS FIRED. ANY AMMUNITION THAT IS IMPROPERLY MANUFACTURED OR RELOADED, EVEN IN THE SLIGHTEST DEGREE, MAY FAIL TO FIRE OR MAY GENERATE EXCESSIVE INTERNAL PRESSURES WHICH CAN DAMAGE OR EVEN RUPTURE THE FIREARM, CAUSING PERSONAL INJURY OR DEATH TO THE SHOOTER OR THOSE IN THE IMMEDIATE VICINITY.**

- A firearm and ammunition are a system and must work together. There are different types of ammunition for different types of firearms. Your firearm has been designed for ammunition of a specific type and a specific gauge or caliber. It is important to select the proper ammunition for your firearm.
- Different combinations of bullet velocity, bullet weight and firearm weight can have major impact on felt recoil; high felt recoil can be uncomfortable to some shooters.

For example:

- Firearm Weight: lower firearm weight increases felt recoil.
- Bullet Weight: higher bullet weight increases felt recoil.
- Bullet Velocity: higher bullet velocity increases felt recoil.

To acclimate yourself to higher levels of felt recoil, consider the following:

- Use a firm two-hand hold on the grip when firing.
- Always start your shooting experience with the lowest bullet velocity and lowest bullet weight available for your firearm.
- Ask your firearm dealer to suggest the lowest power, lowest velocity, lightest bullet weight for your firearm.



**WARNING: NEVER USE AMMUNITION OF THE INCORRECT GAUGE OR CALIBER. USING AMMUNITION OF THE INCORRECT GAUGE OR CALIBER MAY CAUSE DAMAGE TO YOUR FIREARM AND POSSIBLE SERIOUS INJURY TO YOU AND TO OTHERS.**

## AMMUNITION CONTINUED



**WARNING: NEVER USE CARTRIDGES OTHER THAN THOSE DESIGNATED BY THE MARKING ON THE FIREARM. DOING SO CAN RESULT IN DANGEROUSLY HIGH PRESSURES THAT MAY DAMAGE THE FIREARM AND POSSIBLY CAUSE SERIOUS INJURY TO YOURSELF AND OTHERS.**



**WARNING: DEATH, SERIOUS INJURY AND PROPERTY DAMAGE CAN RESULT FROM THE USE OF INCORRECT AMMUNITION OR BORE OBSTRUCTIONS. NEVER USE RELOADED AMMUNITION THAT HAS NOT BEEN SUBJECTED TO INTERNAL BALLISTIC PRESSURE TESTING. SEE PAGE 10 FOR DETAILS.**

- “Plus-P” (+P) ammunition generates pressures in excess of the pressures associated with standard ammunition. Such pressures may affect the wear characteristics and may result in the need for more frequent service.
- “Plus-P-Plus” (+P+) ammunition must not be used in Smith & Wesson® firearms. This marking on the ammunition designates that it exceeds established industry standards, but the designation does not represent defined pressure limits and therefore such ammunition may vary significantly as to the pressures generated and could be DANGEROUS.

Marking on Firearm	Ammunition Type		
	Standard	+P	+P+
380 AUTO	OK	NO	NO
9mm Luger	OK	OK	NO
9x21mm	OK	NO	NO
38 Super	OK	OK	NO
357 SIG	OK	NO	NO
40 S&W	OK	NO	NO
45 AUTO	OK	OK	NO

- Some brands of ammunition may cause difficulty in extracting spent cartridge cases from the chamber. If this situation occurs, thoroughly clean the chamber with solvent. If this condition persists, we recommend changing to another brand of ammunition.

# MODEL AND FEATURES IDENTIFICATION



**WARNING: YOU MUST DETERMINE WHICH FEATURES ARE PRESENT ON YOUR SPECIFIC SMITH & WESSON® PISTOL AND HOW THOSE FEATURES OPERATE. VARIOUS MODELS OF THE PISTOL ARE FITTED WITH DISTINCT FEATURES, WHICH MAY INCLUDE: ONE OF TWO LOADED CHAMBER INDICATORS AND A MAGAZINE SAFETY. SEE THE SECTION(S) OF THIS MANUAL THAT DETAIL EACH OF THESE FEATURES.**

# INSPECTING YOUR PISTOL



**WARNING: ALWAYS KEEP THE MUZZLE POINTED IN A SAFE DIRECTION.**



**WARNING: ALWAYS ENSURE THAT THE FIREARM IS UNLOADED BEFORE INSPECTING, DISASSEMBLING, ASSEMBLING OR CLEANING IT.**



**WARNING: NEVER RELY ON MECHANICAL FEATURES ALONE. ONLY YOUR SAFE FIREARM HANDLING WILL ENSURE THE SAFE USE OF YOUR FIREARM. THIS IS YOUR RESPONSIBILITY.**

- When you inspect your pistol, you should first check for yourself to ensure that it is unloaded. To do this, grasp the pistol with your finger off the trigger and outside the trigger guard, point the muzzle in a safe direction, depress the magazine release and remove the magazine (FIGURE 5).



FIGURE 5

- Point the muzzle in a safe direction, grasp the serrated sides of the slide from the rear with the thumb and fingers (FIGURE 6) and briskly draw the slide fully rearward in order to extract any cartridge from the barrel chamber and clear it from the pistol. Do not obstruct the ejection port because doing so can interfere with ejection of a cartridge.

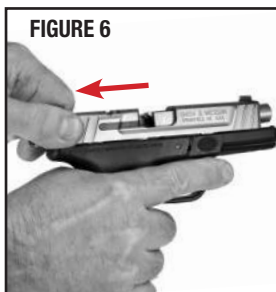

FIGURE 6

- Lock the slide in the open position by allowing the slide to move slightly forward from the rearmost position while pressing upward on the slide stop (FIGURE 7).

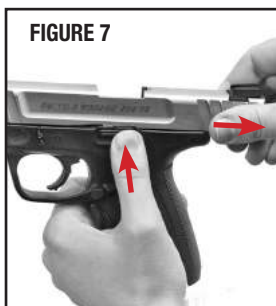

FIGURE 7

- Remove the empty chamber flag from the pistol if one is present.
- Check the barrel chamber and the bore visually for any obstructions and remove any that are found (FIGURE 8).

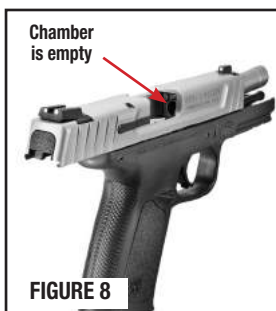
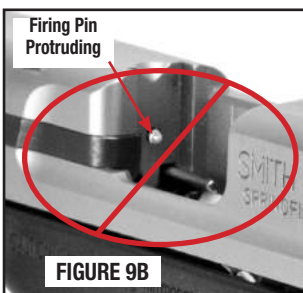
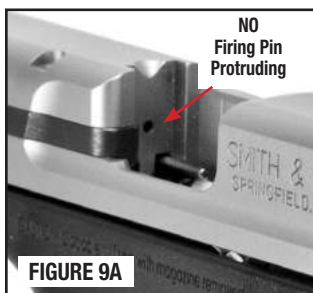

FIGURE 8

- Before using your firearm for the first time, it should be cleaned. See the cleaning section of this manual.

## INSPECTING YOUR PISTOL CONTINUED

- Examine the breech face (FIGURES 9A and 9B) to ensure that the firing pin is not protruding from the breech face. If the firing pin is protruding, do not attempt to load or fire the firearm. Bring the firearm to a gunsmith qualified to perform service on Smith & Wesson® firearms.



**WARNING: VERIFY THAT THE FIRING PIN IS NOT PROTRUDING FROM THE BREECH FACE. IF THE FIRING PIN IS PROTRUDING, MAKE SURE THE FIREARM IS POINTED IN A SAFE DIRECTION, UNLOAD THE FIREARM AND HAVE IT INSPECTED AND TEST FIRED BY A GUNSMITH QUALIFIED TO PERFORM SERVICE ON SMITH & WESSON FIREARMS.**

- Unload the magazine by holding it with the bullet end of the cartridge pointing away from you and others and pressing each cartridge forward and out of the magazine (FIGURE 10).
- You must follow this procedure every time a firearm leaves your hand, is cleaned, handed to you or another person, transported or stored.



## LOADED CHAMBER INDICATOR



**WARNING: NEVER RELY UPON THE LOADED CHAMBER INDICATOR ALONE TO VERIFY THE PRESENCE OR ABSENCE OF A ROUND IN THE CHAMBER. THE SUREST METHOD TO DETERMINE THE PRESENCE OR ABSENCE OF A ROUND IN THE CHAMBER IS TO VISUALLY CHECK THE CHAMBER OF YOUR FIREARM BY REMOVING THE MAGAZINE AND PULLING AND LOCKING THE SLIDE IN THE OPEN POSITION.**

- These Smith & Wesson® pistols come with a loaded chamber indicator, there are two types that may be encountered:

- Type 1: This indicator can be observed by looking at the top of the slide/ejection port, (FIGURE 11) noting an opening at the rear of the barrel hood. By looking into this opening, you can observe whether or not a round is in the firearm's chamber. If a round is in the chamber, you should be able to see the actual cartridge rim through this opening.

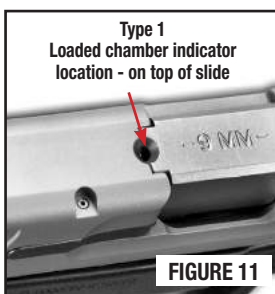

FIGURE 11

- Type 2: Some Smith & Wesson® pistols are equipped with a tactile loaded chamber indicator. This indicator is present on the top of the slide. When the chamber is empty, the loaded chamber indicator will be flush with the top of the slide. When the chamber is loaded, the front of the loaded chamber indicator will protrude from the top of the slide where it can be felt above the slide's surface (FIGURES 12 and 13).

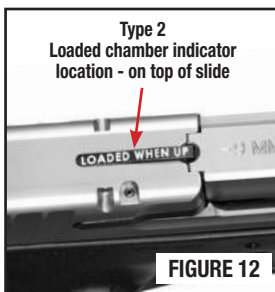

FIGURE 12



**WARNING: ALWAYS TREAT EVERY FIREARM AS IF IT IS LOADED AND WILL FIRE IF THE TRIGGER IS PULLED. A LOADED CHAMBER INDICATOR MAY HELP DETERMINE WHETHER THE CHAMBER IS LOADED OR UNLOADED. THE AMOUNT OF LIGHT, CLEANLINESS OF THE PISTOL, COLOR OF THE AMMUNITION AND OTHER FACTORS MAY LIMIT THE EFFECTIVENESS OF THE LOADED CHAMBER INDICATOR.**

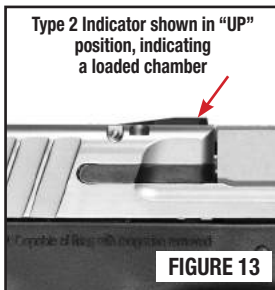

FIGURE 13

## PREPARATION FOR FIRING



**WARNING: YOU MUST DETERMINE WHICH FEATURES ARE PRESENT ON YOUR SPECIFIC SMITH & WESSON PISTOL AND HOW THOSE FEATURES OPERATE. VARIOUS MODELS OF THE S&W PISTOLS ARE FITTED WITH DISTINCT FEATURES, WHICH MAY INCLUDE: ONE OF TWO LOADED CHAMBER INDICATORS AND A MAGAZINE SAFETY. SEE THE SECTION(S) OF THIS MANUAL THAT DETAIL EACH OF THESE FEATURES. IF YOUR SMITH & WESSON PISTOL IS NOT EQUIPPED WITH A MAGAZINE SAFETY, THE PISTOL CAN BE FIRED WHEN THE MAGAZINE IS REMOVED FROM THE PISTOL. KEEP YOUR FINGER OFF THE TRIGGER AND OUTSIDE OF THE TRIGGER GUARD UNTIL YOU HAVE MADE THE COMMITMENT TO FIRE.**



**WARNING: THE FAILURE TO FOLLOW THESE FIREARM SAFETY REQUIREMENTS WILL CAUSE SERIOUS PERSONAL INJURY OR DEATH TO YOU OR OTHERS.**

- **ALWAYS TREAT ALL FIREARMS AS IF THEY ARE LOADED.**
- **ALWAYS BE SURE THAT THE CHAMBER IS CLEAR OF A CARTRIDGE, THE MAGAZINE IS REMOVED OR UNLOADED, AND THAT THE FIREARM IS POINTING IN A SAFE DIRECTION.**
- **ALWAYS KEEP FINGERS AND OTHER PARTS OF YOUR BODY AWAY FROM THE MUZZLE AND AWAY FROM THE PISTOL SLIDE AND EJECTION PORT.**
- **ALWAYS WEAR ADEQUATE AND PROPER HEARING PROTECTION SPECIFIED FOR FIREARM USE** to prevent permanent damage to your hearing. Make sure others who are nearby are wearing hearing protection as well.
- **ALWAYS WEAR SAFETY GLASSES SPECIFIED FOR FIREARM USE,** whether indoors or out. Safety glasses should protect your eyes from the firing flash and particles associated with the discharge of ammunition. Failure to do so creates a risk of personal injury from particle or debris spitting or a ricochet.
- **ALWAYS BE ALERT AND ALWAYS FOLLOW THE SAFETY INSTRUCTIONS OF THE RANGE OFFICER.** Never shoot if you are tired, cold or impaired in any way.
- **ALWAYS BE AWARE OF OTHER PEOPLE** so that persons do not accidentally walk into the line of fire.
- **THE SHOOTER (AND ALL OTHERS IN THE SHOOTING AREA) MUST ALWAYS BE IN A POSITION THAT IS OUT OF THE LINE OF FIRE** and are not within an area where they may be struck by a ricochet or particles spitting from a firearm, or by ejected cases from some types of firearms.



---

## PREPARATION FOR FIRING CONTINUED

---

- **NEVER SHOOT AT ANY SURFACES THAT MAY CAUSE A RICOCHET.**  
Always select a place to shoot that has a safe backstop, is free from obstructions and has no surfaces which may cause a ricochet.
- **NEVER FIRE RANDOMLY INTO THE SKY.** Always select a place to shoot that has a safe backstop.
- **NEVER USE ALCOHOL OR DRUGS BEFORE OR WHILE SHOOTING OR HANDLING ANY FIREARM.**

---

## LOADING

---



**WARNING: ALWAYS KEEP THE MUZZLE POINTED IN A SAFE DIRECTION.**

- Do not load the pistol until you have read and fully understand this manual.
- Do not load the pistol until you are ready to use it. Keep your finger off the trigger and outside the trigger guard until you are ready to fire.
- Never load your pistol until you are sure of your target, what is beyond it and are fully prepared to fire.

**NOTE:** After inserting a magazine, always test to make sure it is locked in place by applying some removal pressure to the exposed portion of the magazine butt plate.

- If the magazine is removed with a round left in the chamber, be sure to holster or otherwise safely secure the pistol under your direct control while the magazine is being reloaded.
- Smith & Wesson® has provided you with a magazine designed to operate in your specific model of pistol. While your magazine may be able to be inserted into another model pistol, it will only function properly in the specific model for which it was designed. Do not interchange magazines from one model pistol to another model pistol.
- Follow instructions in this manual and any other specific instructions which may be marked onto, or accompany, a magazine. Failure to use the particular type of Smith & Wesson® magazine specified for your model and caliber of pistol may result in a malfunction.

## LOADING CONTINUED

- Load the magazine by pressing a cartridge head (rear of cartridge) downward on the forward portion of the magazine follower (or downward on the case of the previously loaded cartridge) and sliding the cartridge fully under the lips of the magazine until the cartridge head is against the rear wall of the magazine. (FIGURE 14) Repeat the procedure for the number of cartridges you wish to load, up to the magazine capacity. Do not attempt to load your magazine with more than the specified number of cartridges because doing so can cause a feeding failure.



FIGURE 14

- Inspect your pistol as previously described in the “Inspecting Your Pistol” section. Hold the pistol in one hand with the muzzle pointing in a safe direction and with your finger off the trigger and outside the trigger guard. Insert the loaded magazine into the magazine well (opening) of the pistol until it is locked in place.

**WARNING: VERIFY THAT THE FIRING PIN IS NOT PROTRUDING FROM THE BREECH FACE. IF THE FIRING PIN IS PROTRUDING, MAKE SURE THE FIREARM IS POINTED IN A SAFE DIRECTION, UNLOAD THE FIREARM AND HAVE IT INSPECTED AND TEST FIRED BY A GUNSMITH QUALIFIED TO PERFORM SERVICE ON SMITH & WESSON® FIREARMS.**

**WARNING: DO NOT USE EXCESSIVE UPWARD FORCE WHEN INSERTING A LOADED MAGAZINE INTO THE PISTOL. EXCESSIVE UPWARD FORCE COULD CAUSE THE SLIDE TO MOVE FORWARD, CHAMBERING A ROUND AND MAKING THE PISTOL READY TO FIRE.**

**NOTE:** After inserting a magazine, test to make sure it is locked in place by applying some downward removal pressure to the exposed portion of the magazine butt plate.

- Pull the slide to the rear and release it to allow the slide to carry fully forward. This strips a cartridge from the magazine and seats it in the chamber of the barrel.

**WARNING: IF THE CARTRIDGE FAILS TO STRIP FROM THE MAGAZINE OR FULLY SEAT INTO THE CHAMBER, IMMEDIATELY STOP THE LOADING PROCESS. REMOVE THE MAGAZINE, LOCK THE SLIDE OPEN AND VERIFY THAT THE CHAMBER IS EMPTY. REFER TO THE “INSPECTING YOUR PISTOL” SECTION OF THIS MANUAL.**

## LOADING CONTINUED



**WARNING: ALWAYS LOAD A ROUND INTO THE CHAMBER BY FEEDING IT FROM THE MAGAZINE. FAILURE TO FOLLOW THIS WARNING CAN RESULT IN SEVERE INJURY OR DEATH TO YOU OR OTHERS. NEVER ATTEMPT TO LOAD THE PISTOL BY INSERTING A ROUND INTO THE OPEN EJECTION PORT.**

**CAUTION:** The pistol can now be fired by pulling the trigger to the rear.

- If you wish to restore the magazine in your pistol to its full capacity, depress the magazine release and remove the magazine from the pistol. Remember that there is a round in the chamber; therefore, the pistol should be holstered or safely secured during this process without touching the trigger. Those variations of the Smith & Wesson® pistol without a magazine safety can be fired with the magazine removed. Load one cartridge into the magazine to replace the one which was chambered when you allowed the slide to carry it forward.



**WARNING: IF YOUR SMITH & WESSON® PISTOL IS NOT EQUIPPED WITH A MAGAZINE SAFETY (SEE PAGE 36 TO IDENTIFY THIS VARIATION), THE PISTOL CAN BE FIRED WHEN THE MAGAZINE IS REMOVED FROM THE PISTOL. KEEP YOUR FINGER OFF THE TRIGGER AND OUTSIDE OF THE TRIGGER GUARD UNTIL YOU HAVE MADE THE COMMITMENT TO FIRE.**

- Reinsert the loaded magazine into the magazine well of the pistol until it is locked in place. To make sure that the magazine is again fully and securely inserted, apply some removal pressure to the exposed portion of the magazine butt plate.
- Your pistol and its magazine are now fully loaded and will fire when the trigger is pulled. Remember to keep your pistol pointed in a safe direction under all conditions and always keep your finger or any other object off the trigger and outside the trigger guard until you have made the commitment to fire the handgun. Never leave a loaded firearm out of your direct control.

## FIRING



**WARNING: ALWAYS KEEP THE MUZZLE POINTED IN A SAFE DIRECTION.**



**WARNING: UPON RELEASING THE SLIDE FROM THE SLIDE STOP OR UPON FIRING THE PISTOL, THE SLIDE MOVES WITH SIGNIFICANT FORCE AND SPEED BOTH FORWARD AND REARWARD (FIGURE 15). TO AVOID INJURY, BE CERTAIN THAT NO PART OF YOUR BODY IS IN THE PATH OF THE SLIDE'S TRAVEL.**



**WARNING: WEAR EYE AND HEARING PROTECTION SPECIFIED FOR FIREARM USE EVERY TIME YOU DISCHARGE YOUR FIREARM. MAKE SURE OTHERS IN THE VICINITY OF WHERE YOU WILL BE SHOOTING DO SO AS WELL.**



**WARNING: IF YOUR SMITH & WESSON® PISTOL IS EQUIPPED WITH A MAGAZINE SAFETY (SEE PAGE 36 TO IDENTIFY THIS VARIATION), THE PISTOL WILL NOT FIRE WITH THE MAGAZINE REMOVED. YOU MUST FULLY RELEASE THE TRIGGER AND REMOVE YOUR FINGER FROM WITHIN THE TRIGGER GUARD WHEN THE MAGAZINE IS REMOVED FROM THE PISTOL. FAILURE TO FULLY RELEASE THE TRIGGER COULD RESULT IN AN ACCIDENTAL DISCHARGE WHEN THE TRIGGER IS THEN PULLED THE REST OF THE WAY REARWARD REGARDLESS OF THE PRESENCE OF A MAGAZINE IN THE PISTOL. "STAGING" THE TRIGGER (KEEPING TENSION ON THE TRIGGER) VIOLATES A BASIC RULE OF FIREARM SAFETY WHICH WARNS YOU TO KEEP YOUR FINGER OUT OF THE TRIGGER GUARD UNTIL YOU HAVE MADE THE COMMITMENT TO FIRE. "STAGING" CREATES A SERIOUS RISK OF PERSONAL INJURY OR DEATH SINCE IT MAY LEAD TO AN UNINTENTIONAL DISCHARGE.**

- It has come to our attention that some users of Smith & Wesson® handguns may "stage" the trigger in anticipation of firing a shot. Staging is the act of pulling the trigger rearward toward – stopping just short of – the point where the handgun fires. Such manipulation of the trigger can reduce the user's control of the handgun and can result in an unintentional discharge. Furthermore, if the user decides not to fire, release of the trigger from a position close to the firing point in the staging process could result in an unintentional discharge.

## FIRING CONTINUED

- Keep the muzzle pointed in a safe direction and your finger outside the trigger guard until you are ready to fire. Each shot will be fired in the striker fire action mode. While holding the grip firmly, pull the trigger fully to the rear. As the trigger is drawn fully to the rear, the striker assembly is released, striking the cartridge primer. Upon firing, the slide moves rearward thereby extracting and ejecting the spent cartridge case. The slide then returns forward feeding the next cartridge from the magazine into the barrel chamber.
- After firing you must allow the trigger to move forward fully before you can fire another shot. Failure to do so will prevent the lock work from fully cycling and will prevent your being able to fire the next shot. Keep your finger off the trigger and outside the trigger guard until you are ready to fire again. This sequence can be repeated until the last round has been fired, at which time the magazine follower exerts upward pressure on the slide stop causing it to engage the slide and to hold it in the “open” position.

## HANGFIRES AND MISFIRES



**WARNING: ALWAYS KEEP THE MUZZLE POINTED IN A SAFE DIRECTION.**



**WARNING: WEAR EYE AND HEARING PROTECTION SPECIFIED FOR USE WITH FIREARMS WHEN FIRING AND CLEARING MISFIRES OR MISFEEDS.**



**WARNING: KEEP YOUR FACE A SAFE DISTANCE FROM THE EJECTION PORT WHEN CLEARING A CARTRIDGE. IF A CARTRIDGE IGNITES WHILE BEING CLEARED FROM THE FIREARM, DEATH OR SERIOUS INJURY MAY RESULT.**



**WARNING: IF YOUR FIREARM GIVES ANY INDICATION THAT IT IS NOT PERFORMING PROPERLY OR THE OPERATION OF YOUR FIREARM HAS CHANGED “THE WAY IT FEELS OR SOUNDS”, STOP FIRING. MAKE SURE THE FIREARM IS POINTED IN A SAFE DIRECTION, UNLOAD THE FIREARM AND HAVE IT INSPECTED AND TEST FIRED BY A GUNSMITH QUALIFIED TO PERFORM SERVICES ON SMITH & WESSON® FIREARMS.**



**WARNING: IF YOUR SMITH & WESSON® PISTOL IS NOT EQUIPPED WITH A MAGAZINE SAFETY (SEE PAGE 36 TO IDENTIFY THIS VARIATION), THE PISTOL CAN BE FIRED WHEN THE MAGAZINE IS REMOVED FROM THE PISTOL. KEEP YOUR FINGER OFF THE TRIGGER AND OUTSIDE OF THE TRIGGER GUARD UNTIL YOU HAVE MADE THE COMMITMENT TO FIRE.**

## HANGFIRES AND MISFIRES CONTINUED

**NOTE:** In the case of either a hangfire or misfire, keep the muzzle pointed in a safe direction and your finger off the trigger. Wait 60 seconds, then press the magazine catch and remove the magazine from the pistol (FIGURE 16). Proceed to clear the unfired cartridge from the chamber.



- A **HANGFIRE** is described as a noticeable delay between the impact of the firing pin on the primer of the cartridge and the actual discharge of the firearm. This is generally caused by defective or damaged ammunition.
- If a cartridge has delayed ignition and goes off after a delay, with the firearm pointed in a safe direction, the magazine should be removed and the firearm should be unloaded. The remainder of similar ammunition should be inspected to determine if it has been contaminated or damaged and dealt with accordingly.
- A **MISFIRE** is the failure of the chambered cartridge to fire at all after the trigger has been pulled. This is generally caused by defective or damaged ammunition or a dirty or fouled firearm.

- A light primer strike caused by a dirty or fouled firearm can lead to misfires. If a light indent on the primer of a misfire is noted, unload the firearm and clean it as instructed in the Cleaning and Maintenance section of this manual. If the cartridge does not go off, the “dud” cartridge needs to be removed from the firearm.

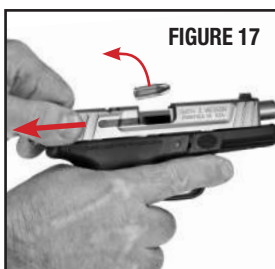

- With the magazine removed from the pistol, pull the slide all the way back (FIGURE 17) to remove the round from the chamber.
- Press up on the slide stop and let the slide move forward against the slide stop to lock the slide open (FIGURE 18).

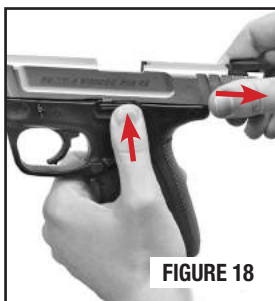

## HANGFIRES AND MISFIRES CONTINUED

- Visually check the chamber (FIGURE 19) and the magazine well (FIGURE 20) to be certain that no cartridges are present.
- The firearm should be inspected and cleaned before returning it to use.
- The ammunition should be inspected and any damaged or defective rounds should not be used.
- Dispose of defective cartridge(s) in a method specifically approved for live round disposal.

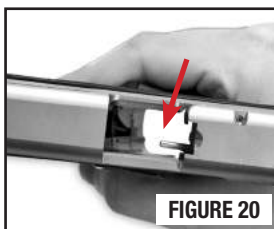

**WARNING: IF YOUR PISTOL IS NOT EQUIPPED WITH A MAGAZINE SAFETY (SEE PAGE 36 TO IDENTIFY THIS VARIATION), IT CAN BE FIRED WHEN THE MAGAZINE IS REMOVED FROM THE PISTOL. KEEP YOUR FINGER OFF THE TRIGGER AND OUTSIDE OF THE TRIGGER GUARD UNTIL YOU HAVE MADE THE COMMITMENT TO FIRE.**

## CLEARING A MISFEED/JAM

**NOTE:** Any autoloading firearm may, on occasion, fail to feed a cartridge properly from the magazine and into the chamber. If this should occur:

**WARNING: KEEP YOUR FACE A SAFE DISTANCE FROM THE EJECTION PORT WHEN CLEARING A MISFEED/JAMMED CARTRIDGE. A CARTRIDGE MAY IGNITE IF THE PRIMER OF THE CARTRIDGE IS STRUCK WITH SUFFICIENT FORCE. IF A CARTRIDGE IGNITES WHILE BEING CLEARED FROM THE FIREARM, DEATH OR SERIOUS INJURY MAY RESULT.**

### TO CLEAR A MISFEED (“JAM”)

- Make certain that the muzzle is pointed in a safe direction.
- Press the magazine catch and remove the magazine from the pistol (FIGURE 21).
- Pull the slide fully rearward and engage the slide stop (FIGURE 22) to lock the slide open.

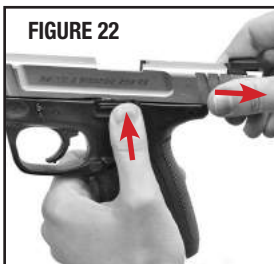

## CLEARING A MISFEED/JAM CONTINUED

**NOTE:** Drawing the slide fully to the rear should allow clearance for the jammed cartridge to fall free and clear of the firearm.

- It may be necessary to manually remove a jammed cartridge. When attempting to clear a jam manually, use only wood 'tools', such as a pointed dowel or a pencil, and use extreme care to avoid striking the primer of the cartridge.
- Visually check to make sure all cartridges have been removed from the firearm (FIGURES 23 and 24).
- Once the jammed cartridge is cleared, proceed to load the firearm as instructed in the Loading Section of this manual.
- Dispose of defective cartridge(s) in a method specifically approved for live round disposal.

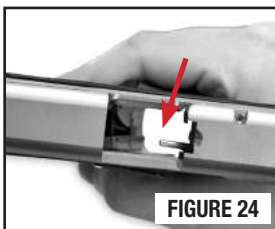
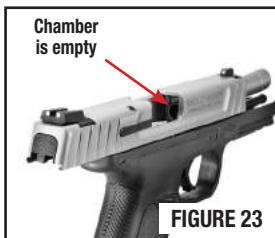

## UNLOADING



**WARNING: ALWAYS KEEP YOUR PISTOL POINTED IN A SAFE DIRECTION. ALWAYS KEEP YOUR FINGER OFF THE TRIGGER AND OUTSIDE THE TRIGGER GUARD WHEN UNLOADING.**

- Make sure your finger is off the trigger and out of the trigger guard. Depress the magazine release and remove the magazine (FIGURE 25).
- Keep the muzzle still pointed in a safe direction, and keep your finger off the trigger and outside the trigger guard, grasp the serrated sides of the slide from the rear with the thumb and fingers, (FIGURE 26) and briskly draw the slide fully rearward in order to extract any cartridge from the barrel chamber and clear it from the pistol. Do not obstruct the ejection port because doing so can interfere with ejection of a cartridge.

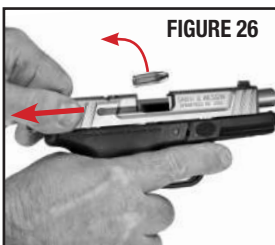



## CLEARING A MISFEED/JAM CONTINUED

- Lock the slide in the open position by allowing the slide to move slightly forward from the rearmost position while pressing upward on the slide stop (FIGURE 27).
- Visually check the barrel chamber to be sure it is empty (FIGURE 28).
- Look into the chamber and down through the magazine well. Verify that no ammunition remains in the pistol (FIGURE 29).
- Unload the magazine by holding it with the bullet end of the cartridge pointing away from you and pressing each cartridge forward and out of the magazine (FIGURE 30).

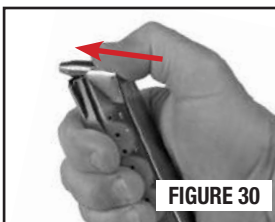
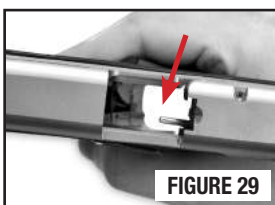
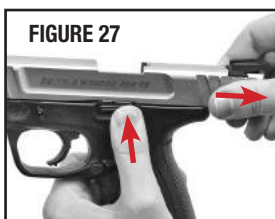

## FIELD STRIPPING/DISASSEMBLY

For Those Models Without Magazine Safety - See Page 36 To Identify This Variation.



**WARNING: ALWAYS KEEP THE MUZZLE POINTED IN A SAFE DIRECTION.**



**WARNING: ALWAYS ENSURE THAT THE FIREARM IS UNLOADED BEFORE INSPECTING, DISASSEMBLING, ASSEMBLING OR CLEANING.**



**WARNING: ALWAYS FOLLOW THE FIELD STRIPPING INSTRUCTIONS EXACTLY. NEVER DO ANYTHING BEYOND WHAT YOU ARE SPECIFICALLY INSTRUCTED TO DO IN THIS MANUAL. NEVER ALTER OR MODIFY THE PARTS IN YOUR PISTOL.**



**WARNING: WEAR SAFETY GLASSES EVERY TIME YOU DISASSEMBLE OR ASSEMBLE YOUR FIREARM.**

## FIELD STRIPPING / DISASSEMBLY CONTINUED

### For Those Models Without Magazine Safety

- Point the muzzle in a safe direction. Make sure your finger is off the trigger and out of the trigger guard. Depress the magazine release and remove the magazine (FIGURE 31).



- With the muzzle still pointing in a safe direction, and with your finger off the trigger and outside the trigger guard, grasp the serrated sides of the slide from the rear with the thumb and fingers (FIGURE 32) while holding the firearm in an upright position, and briskly draw the slide fully rearward in order to extract any cartridge from the barrel chamber and clear it from the pistol.

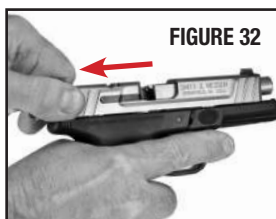

- Make certain that the chamber is clear (FIGURE 33).



**WARNING: TO COMPLETE DISASSEMBLY, YOU WILL BE REQUIRED TO PULL THE TRIGGER. IF YOU HAVE FAILED TO PROPERLY UNLOAD YOUR PISTOL AND A ROUND IS LEFT IN THE CHAMBER, THE PISTOL WILL DISCHARGE AND MAY CAUSE SERIOUS INJURY OR DEATH TO YOURSELF OR OTHERS AND DAMAGE TO PROPERTY. THEREFORE, YOU MUST VISUALLY INSPECT THE CHAMBER AND MAGAZINE WELL (OPENING) TO ENSURE THAT THEY ARE EMPTY BEFORE PULLING THE TRIGGER.**

- Close the slide on an empty chamber by grasping the serrated sides of the slide from the rear with the thumb and fingers, pulling slightly rearward to disengage the slide stop (FIGURE 34) and then allowing the slide to move fully forward.



- With the pistol still pointing in a safe direction and the slide closed, pull the trigger once and remove your finger from the trigger and out of the trigger guard (FIGURE 35).



## FIELD STRIPPING / DISASSEMBLY CONTINUED

### For Those Models Without Magazine Safety

- Move the slide approximately 1/4" to the rear and hold it firmly in this position (FIGURE 36).



- While holding the slide back slightly, depress the takedown catch (from both sides of the frame at the same time) with your thumb and forefinger (FIGURES 37 and 38).



- Continue to hold the takedown catch down while moving the slide forward about half an inch at which point the catch can be released and the slide can be taken off the frame.

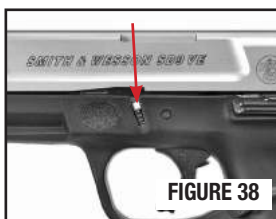

- Remove the slide by pulling it forward while being careful to retain the recoil spring and guide rod assembly (FIGURE 39).

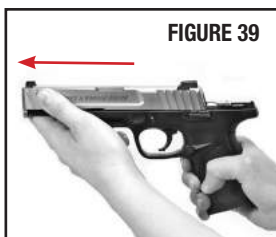

- Remove the recoil spring (FIGURE 40) and barrel (FIGURE 41) from the bottom of the slide.

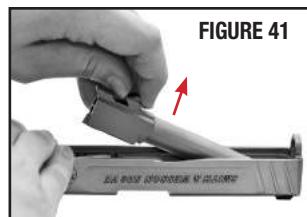

# FIELD STRIPPING/DISASSEMBLY

For Those Models **With** a Magazine Safety - See Page 36 To Identify This Variation



**WARNING: ALWAYS KEEP THE MUZZLE POINTED IN A SAFE DIRECTION.**



**WARNING: ALWAYS FOLLOW THE FIELD STRIPPING INSTRUCTIONS EXACTLY. NEVER DO ANYTHING BEYOND WHAT YOU ARE SPECIFICALLY INSTRUCTED TO DO IN THIS MANUAL. NEVER ALTER OR MODIFY THE PARTS IN YOUR PISTOL.**



**WARNING: WEAR SAFETY GLASSES EVERY TIME YOU ASSEMBLE OR DISASSEMBLE YOUR FIREARM.**

- Point the muzzle in a safe direction. Make sure your finger is off the trigger and out of the trigger guard. Depress the magazine release, and remove the magazine (FIGURE 42).
- With the muzzle still pointing in a safe direction, and with your finger off the trigger and outside the trigger guard, grasp the serrated sides of the slide from the rear with your thumb and fingers (FIGURE 43) While holding the firearm in an upright position, and briskly draw the slide fully rearward in order to extract any cartridge from the barrel chamber and clear it from the pistol.



FIGURE 42

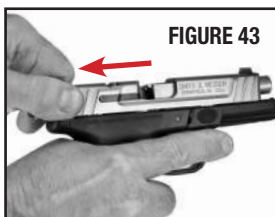

FIGURE 43

- Lock the slide in the open position by allowing the slide to move slightly forward from the rearmost position while pressing upward on the slide stop (FIGURE 44).
- Make certain that the chamber is clear (FIGURE 45).

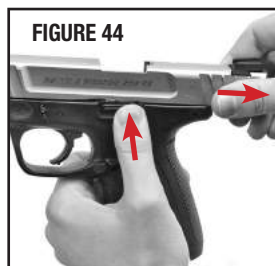

FIGURE 44



FIGURE 45

## FIELD STRIPPING / DISASSEMBLY CONTINUED

### For Those Models With a Magazine Safety Continued

- With the slide locked open and the chamber clear, pull the trigger to the fully rearward position as shown (FIGURE 46).
- Continue holding trigger in the rearward position and using the tip of a flat screwdriver (or similar device), push the takedown lever from its normal “up” position (FIGURE 47) to its lowered “takedown” position (FIGURE 48).
- Release the trigger, it will stay in the rearward position as shown (FIGURE 49) as you continue.



- Grasp the serrated sides of the slide from the rear with your thumb and fingers and pull the slide slightly rearward to disengage the slide stop. Allow the slide to go forward to the closed position.
- Move the slide approximately 1/4” to the rear and hold it firmly in this position (FIGURE 50).
- While holding the slide back 1/4”, depress the takedown catch (from both sides of the frame) with your thumb and forefinger (FIGURE 51).
- Continue to hold the takedown catch down while moving the slide forward about half an inch at which point the catch can be released and the slide can be taken off the frame.



## FIELD STRIPPING / DISASSEMBLY CONTINUED

### For Those Models With a Magazine Safety Continued

- Remove the slide by pulling it forward while being careful to retain the recoil spring and guide rod assembly (FIGURE 52).
- Remove the recoil spring and barrel from the bottom of the slide (FIGURES 53 and 54).

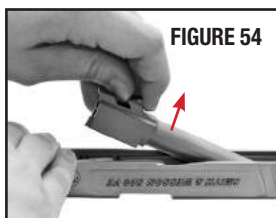

**WARNING: DO NOT ALTER, MODIFY OR REPLACE ANY OF THE PARTS OF YOUR FIREARM UNLESS THIS WORK IS PERFORMED BY A QUALIFIED GUNSMITH USING GENUINE SMITH & WESSON PARTS. IF YOU DO OTHERWISE, IMPROPER FUNCTIONING MAY OCCUR AND SERIOUS INJURY MAY RESULT.**

**WARNING: NEVER DISASSEMBLE YOUR HANDGUN BEYOND THE FIELD STRIPPING PROCESS OUTLINED IN THIS MANUAL. NEVER MANIPULATE ANY INTERNAL COMPONENTS BEYOND WHAT YOU ARE SPECIFICALLY INSTRUCTED TO DO IN THIS MANUAL SINCE THIS MAY AFFECT THE RELIABILITY, FUNCTIONING AND SAFETY OF YOUR HANDGUN.**

## LUBRICATION

- There are six lubrication points (FIGURES 55 and 56) where a single drop of high-quality firearms lubricant should be applied. This will ensure proper lubrication. Care should be taken not to over-lubricate. Excess lubricant can collect large quantities of unburned powder and carbon residue, which could interfere with proper function of the pistol.

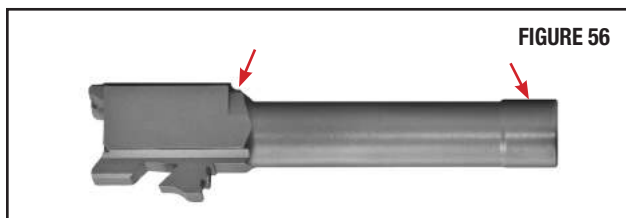

## ASSEMBLY - For All Model Variations



**WARNING: ALWAYS KEEP THE MUZZLE POINTED IN A SAFE DIRECTION.**



**WARNING: ALWAYS FOLLOW THE FIELD STRIPPING INSTRUCTIONS EXACTLY. NEVER DO ANYTHING BEYOND WHAT YOU ARE SPECIFICALLY INSTRUCTED TO DO IN THIS MANUAL. NEVER ALTER OR MODIFY THE PARTS IN YOUR PISTOL.**



**WARNING: WEAR SAFETY GLASSES EVERY TIME YOU ASSEMBLE OR DISASSEMBLE YOUR FIREARM.**

- With the bottom of the slide turned up, replace the barrel in the slide so the muzzle is flush with the end of the slide and the barrel lug is turned up (away from the ejection port) (FIGURES 57 and 58).

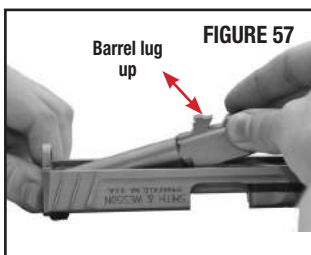

- Insert the protruding button end of the recoil spring guide assembly into the slide guide housing (FIGURE 59).
- Make sure it is properly centered (FIGURES 60 through 63).

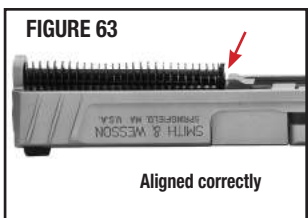
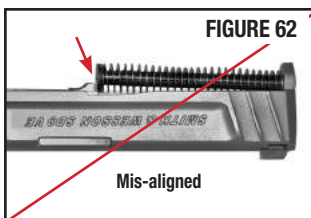
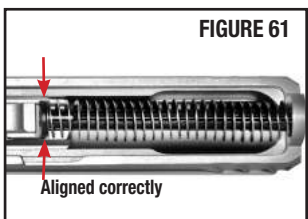
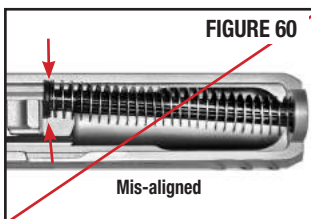



## ASSEMBLY CONTINUED - For All Model Variations

- Holding the slide and recoil spring guide firmly in one hand, place the rear of the slide onto the front frame rails (FIGURES 64 and 65).



- Continue moving the slide rearward onto the rear frame rails (FIGURE 66) until the slide is fully rearward.

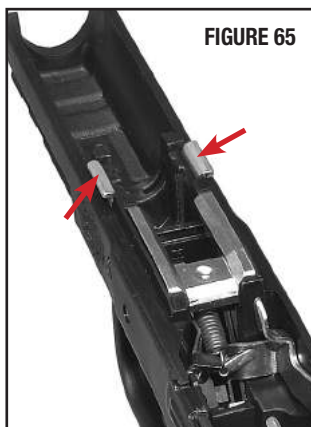

- Once the slide is fully rearward on the frame rails, allow it to move forward to the closed position.

- Reinsert the magazine.

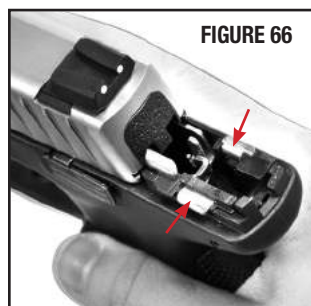

**NOTE:** For those pistols with a magazine safety, the trigger will stay in the rearward position until the magazine is reinserted into the pistol. When the magazine is inserted fully into the pistol it will push the takedown lever into its normal “up” position, allowing the pistol to function properly.

## SIGHT ADJUSTMENT



**WARNING: ENSURE YOUR FIREARM IS UNLOADED BEFORE ADJUSTING YOUR SIGHTS. AT ALL TIMES FOLLOW THE BASIC FIREARMS SAFETY RULES IN THE SECTION OF THIS MANUAL ENTITLED “YOUR SAFETY RESPONSIBILITIES”.**

- The rear sight (FIGURE 67) is drift adjustable for windage only. To adjust, move the rear sight in the direction you wish the group to move on the target. For example, if the group should move to the right, move the rear sight to the right. Use a brass or plastic drift or punch to prevent marring the rear sight or slide.
- If the rear sight has a set screw, loosen the set screw prior to moving the rear sight. Tighten the set screw after the sight has been adjusted to the desired position.



# MAGAZINE



**WARNING: WEAR SAFETY GLASSES EVERY TIME YOU ASSEMBLE OR DISASSEMBLE YOUR MAGAZINE.**



**WARNING: THE MAGAZINE SPRING IS UNDER PRESSURE. CONTROL THE SPRING, FOLLOWER FLOOR PLATE AND FLOOR PLATE CATCH SO THEY DO NOT FLY OUT AND CAUSE INJURY.**

## MAGAZINE DISASSEMBLY (for cleaning)

1. Using a drift punch, depress floor plate catch through the hole in the floor plate (FIGURE 68).
2. Slide floor plate off of the tube while holding floor plate catch in the tube (FIGURE 69).
3. Remove floor plate catch and spring and follower out through bottom of tube (FIGURE 70).

- FIGURE 71 shows the magazine parts in their disassembled state for clarity.

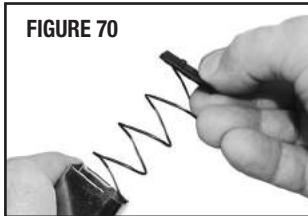
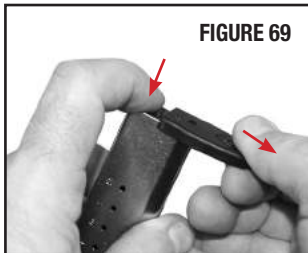
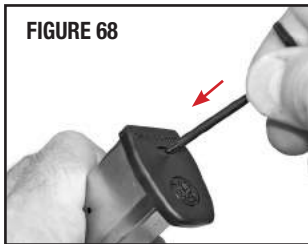

## MAGAZINE REASSEMBLY

1. Install magazine spring and follower and floor plate catch into the tube in exactly the same orientation as they were in when they were first removed during disassembly
2. While holding floor plate catch in tube, slide floor plate into tube so that the round projection of the floor plate catch engages the floor plate.

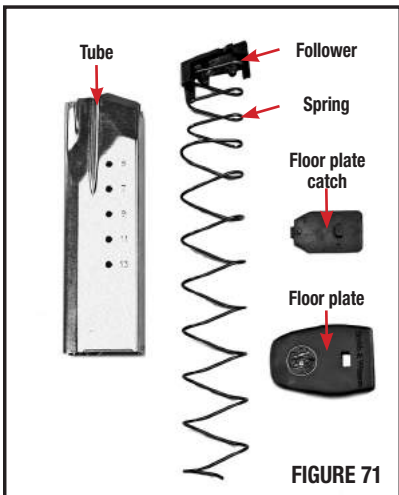

# MAGAZINE SAFETY

## For Those Models So-Equipped

- Your Smith & Wesson® pistol may be equipped with a magazine safety which prevents the pistol from firing when the magazine is removed from the pistol. Review FIGURES 72 and 73 to determine if your pistol has this feature. The takedown procedure is different if the magazine safety is present, see appropriate section in this manual.

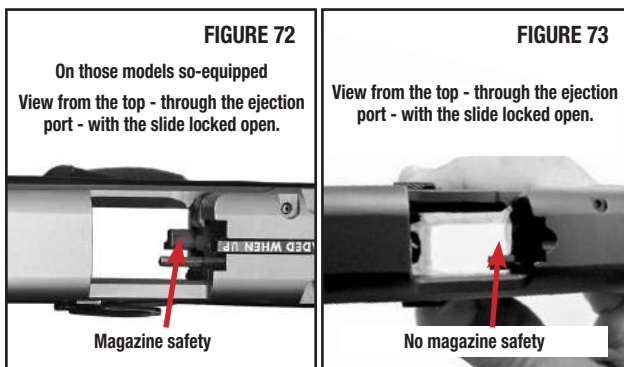

**WARNING: SOME SMITH & WESSON® PISTOLS ARE DESIGNED TO DISENGAGE THE TRIGGER LINKAGE WHEN THE MAGAZINE IS REMOVED, PREVENTING THE PISTOL FROM FIRING WHEN THE TRIGGER IS PULLED.**

**WARNING: IF YOUR SMITH & WESSON® PISTOL IS EQUIPPED WITH A MAGAZINE SAFETY THE PISTOL WILL NOT FIRE WITH THE MAGAZINE REMOVED. YOU MUST FULLY RELEASE THE TRIGGER AND REMOVE YOUR FINGER FROM WITHIN THE TRIGGER GUARD WHEN THE MAGAZINE IS REMOVED FROM THE PISTOL. FAILURE TO FULLY RELEASE THE TRIGGER COULD RESULT IN AN ACCIDENTAL DISCHARGE WHEN THE TRIGGER IS THEN PULLED THE REST OF THE WAY REARWARD REGARDLESS OF THE PRESENCE OF A MAGAZINE IN THE PISTOL. "STAGING" THE TRIGGER (KEEPING TENSION ON THE TRIGGER) VIOLATES A BASIC RULE OF FIREARM SAFETY WHICH WARNS YOU TO KEEP YOUR FINGER OUT OF THE TRIGGER GUARD UNTIL YOU HAVE MADE THE COMMITMENT TO FIRE. "STAGING" CREATES A SERIOUS RISK OF PERSONAL INJURY OR DEATH SINCE IT MAY LEAD TO AN UNINTENTIONAL DISCHARGE.**

- If your pistol IS equipped with this feature, it will have a small lever mechanism in the magazine well (FIGURE 72).
- If the pistol IS NOT equipped with this feature, there will be no small lever present in the magazine well as shown (FIGURE 73).
- The slide can still be opened and closed regardless of the presence of a magazine.

---

## MAGAZINE SAFETY CONTINUED

---



**WARNING: IF YOUR SMITH & WESSON® PISTOL IS NOT EQUIPPED WITH A MAGAZINE SAFETY, THE PISTOL CAN BE FIRED WHEN THE MAGAZINE IS REMOVED FROM THE PISTOL.**



**WARNING: NEVER RELY ON MECHANICAL FEATURES ALONE. ONLY YOUR SAFE GUN HANDLING WILL ENSURE THE SAFE USE OF YOUR FIREARM. THIS IS YOUR RESPONSIBILITY.**

---

## CLEANING AND MAINTENANCE

---



**WARNING: ENSURE THAT YOUR FIREARM IS UNLOADED BEFORE BEGINNING TO CLEAN IT. (SEE “INSPECTING YOUR FIREARM” SECTION). ALWAYS FOLLOW THE RULES OF SAFE GUN HANDLING.**



**WARNING: WEAR SAFETY GLASSES EVERY TIME YOU ASSEMBLE OR DISASSEMBLE YOUR FIREARM AND ATTEMPT CLEANING OR MAINTENANCE.**

- Before using your firearm for the first time, it should be cleaned.
- Your firearm was treated at the factory with either a preservative or oil to protect it against corrosion during shipping and storage.
- Preservative and oil should be wiped from the bore, chamber and exposed areas using a clean swab or patch before using the firearm.

**CAUTION:** Never disassemble your firearm beyond the instructions in the Field Stripping and Inspection sections of this manual.

- Purchase cleaning supplies from your firearms dealer that are specifically designated for your type and caliber of firearm. Many suppliers offer these in kit form for your convenience.
- Follow the instructions provided with your cleaning supplies.

**NOTE:** A basic firearm cleaning kit should include: a brass bore brush and a cleaning jag of appropriate size for the bore being cleaned, high-quality gun cleaning solvent and gun oil/lubricant, cotton cleaning patches and a cleaning rod that is long enough to push the brush and jag completely through the barrel.

- Remove excessive firing residue from the bore and chamber using a properly fitted brass brush dipped in gun cleaning solvent. Finish the bore cleaning process by running a dry cotton cloth patch through the bore to remove residue and solvent.

## CLEANING AND MAINTENANCE CONTINUED

- Clean the exterior of the firearm using a non-abrasive cleaning cloth.
- After cleaning, lightly coat the metal parts, internal and external with a high quality gun oil. Refer to the “Lubrication” section in this manual for instructions on lubricating the firearm.
- Whenever your firearm has been exposed to sand, dust, extreme humidity, water or other adverse conditions, it must be cleaned and lubricated.



**WARNING: ALWAYS HAVE ADEQUATE VENTILATION. CLEANING FIREARMS IN POORLY VENTILATED AREAS, DISCHARGING FIREARMS, OR HANDLING AMMUNITION MAY RESULT IN EXPOSURE TO LEAD AND OTHER SUBSTANCES KNOWN TO CAUSE BIRTH DEFECTS, REPRODUCTIVE HARM, AND OTHER SERIOUS PHYSICAL INJURY. WASH HANDS THOROUGHLY AFTER EXPOSURE.**

**CAUTION:** Always follow the instructions provided with your gun cleaner and gun lubricant.

**CAUTION:** Some cleaners can cause damage to your firearms. You should avoid prolonged solvent immersion and avoid any ultrasonic cleaning of your firearm. Choice of solvent should be restricted to those products specifically developed for firearms maintenance. Damage to a firearm’s finish may occur if these cautions are ignored. Ammoniated solvents or other strong alkaline solvents, should not be used on any Smith & Wesson® firearm.

- Cleaning is essential to ensure the proper functioning of your firearm.
- Your firearm is a precision instrument. To ensure reliable function it is necessary to follow a routine maintenance procedure. After firing your firearm, be sure to unload it following the procedure outlined in the section entitled “Inspecting Your Firearm” before performing any cleaning or maintenance procedure.
- Remove any gun cleaning solution, oil and fingerprints from the outside surfaces of the firearm. (Finger moisture, if left, could start a corrosion process.)



**WARNING: NEVER MANIPULATE, ADJUST OR CHANGE ANY OF THE INTERNAL COMPONENTS OF YOUR FIREARM UNLESS SPECIFICALLY DIRECTED TO DO SO IN THIS MANUAL. IMPROPER MANIPULATION OF ANY INTERNAL COMPONENT MAY AFFECT THE SAFETY AND RELIABILITY OF YOUR FIREARM AND MAY CAUSE SERIOUS INJURY OR DEATH.**

## CLEANING AND MAINTENANCE CONTINUED



**WARNING: ANY MAINTENANCE OR SERVICE NOT SPECIFIED IN THIS MANUAL MUST BE PERFORMED BY A QUALIFIED GUNSMITH USING GENUINE SMITH & WESSON® PARTS. IF YOU DO OTHERWISE, IMPROPER FUNCTIONING OF YOUR FIREARM MAY OCCUR AND SERIOUS INJURY OR DEATH MAY RESULT.**

- If your firearm will be used in a cold climate, be sure to use an oil of an appropriate weight so that it will not congeal in cold temperatures, causing the interaction of important parts to be slowed or halted.

### MAINTENANCE BEFORE STORAGE

- When storing, do not encase your firearm in anything that will attract or hold moisture, for example, leather or heavy cloth. Also, do not store guns with a plug inserted in the barrel for this can be a contributing factor to moisture accumulation. If your firearm is to be stored for an extended period, the bore, chambers and internal working mechanism should be oiled with a high quality lubricating oil or preservative intended for firearms. The external working mechanisms and barrel should be coated with an anti-rust oil. Before using your firearm again, be sure to clean it. Every time you clean your firearm, check it for signs of wear. If excessive wear is noted, do not use the firearm. Return it to Smith & Wesson® for service or have it checked by a qualified gunsmith.



---

# LIMITED WARRANTY

## For Owners Within The United States.

---

This warranty is granted by Smith & Wesson Inc. This warranty is effective from the date of purchase and applies to the original owner of any firearm. With respect to such firearms, this warranty supersedes any and all other warranties.

Smith & Wesson® firearms are warranted to be free from defects in material and workmanship. Any such defects of which Smith & Wesson® receives written notice within one year from the date of purchase by the original owner, will be remedied by Smith & Wesson® without charge within a reasonable time after such notification and delivery of the firearm as provided below.

In the event of an emergency (repairs needed by law enforcement, an upcoming match or hunting trip), call 1-800-331-0852, ext. 4125 and ask for 911 Priority Repair Service. This allows you to speak with a Smith & Wesson® representative. Immediately upon receipt, your firearm will be assigned to a gunsmith. After the work is completed, we will return your Smith & Wesson® firearm via overnight delivery.



To submit a warranty claim please see the “Contact and Shipping Information” below for details. In addition to the requested information, please include a copy of the bill of sale in the owner’s name, or a copy of the ATF Form 4473 indicating date of purchase. It is always important that the owner comply with all applicable federal, state and local laws and regulations.



Warranty claims should state the model and serial number of the firearm concerned and the description of the difficulty experienced. It is recommended that shipments be insured by the owner, since Smith & Wesson® will accept no responsibility for loss or damage in transit. Transportation and insurance charges for return to owner will be paid by Smith & Wesson® if the claim is covered by the warranty.

**UNDER NO CIRCUMSTANCES SHALL SMITH & WESSON® BE RESPONSIBLE FOR INCIDENTAL OR CONSEQUENTIAL DAMAGES WITH RESPECT TO ECONOMIC LOSS, INJURY, DEATH OR PROPERTY DAMAGE, WHETHER AS A RESULT OF BREACH OF THIS WARRANTY, NEGLIGENCE OR OTHERWISE.**

Some states do not allow the exclusion or limitation of incidental or consequential damages, so the above limitation or exclusion may not apply to you.





---

## LIMITED WARRANTY CONTINUED

---

### Smith & Wesson® will not be responsible for:

- Defects or malfunctions resulting from careless handling, unauthorized adjustments or modifications made or attempted by anyone other than a qualified gunsmith following Smith & Wesson authorized procedures, or failure to follow the disassembly instructions in the Smith & Wesson manual.
- Use of defective or improper ammunition, corrosion, neglect, abuse, ordinary wear and tear, or unreasonable use.
- Criminal misuse, negligence or use under the influence of drugs or alcohol.

Smith & Wesson's Lifetime Service Policy begins after the warranty period has expired. Smith & Wesson® will repair, without charge, for the lifetime of the original owner, any Smith & Wesson® handgun purchased on or after February 1, 1989, and any M&P15 series rifle, that is found to have a defect in material or workmanship. Eligibility for this Lifetime Service Policy requires returning the Product Registration Card within 30 days of purchase. The Lifetime Service Policy covers functional defects; it does not include the firearm's finish, grips, magazines or sights. The Lifetime Service Policy is in addition to and not an extension of the Smith & Wesson® Warranty.

This warranty gives you specific legal rights. You may also have other rights that vary from state to state.

**NOTE:** All liability is excluded in the event that the instructions in the Smith & Wesson® manual are not observed.

# CONTACT & SHIPPING INFORMATION

## For Owners Within The United States

**NOTE:** A Return Merchandise Authorization (**RMA**) is the first step in the process of returning a product in order to receive a repair, replacement or refund. Please contact Smith & Wesson's Customer Service Dept. (via e-mail: [qa@smith-wesson.com](mailto:qa@smith-wesson.com) or by phone at 800-331-0852 ext. 4125) to obtain authorization to return your firearm so we can process it quickly and efficiently. The RMA number that is supplied by Smith & Wesson® must be displayed on the outside of the returned product's packaging; returns without an RMA number will be routed differently which will result in delayed processing.

The issuance of an Return Merchandise Authorization (**RMA**) allows Smith & Wesson® an opportunity to try to diagnose and correct a customer's concerns with the product (such as ammunition problems) before it is returned. Accordingly, please contact us before returning your Smith & Wesson® firearm.

### STEP 1: CONTACT CUSTOMER SERVICE

Tel: 800-331-0852 • 413-781-8300 ext. 4125

E-mail: [qa@smith-wesson.com](mailto:qa@smith-wesson.com)

### STEP 2: RETURNS - FOR SERVICE

SEND ALL FIREARMS TO:

Smith & Wesson

2100 Roosevelt Avenue • Springfield, MA 01104

Should your Smith & Wesson® firearm require service, it should be returned to the Smith & Wesson® factory.

- Call or e-mail the Customer Service Dept. for authorization and shipping instructions.
- Ensure that the firearm is unloaded.
- Do not attempt to ship a firearm via US Postal Service; only federally licensed dealers may ship a firearm by US Postal Service.
- **DO NOT SHIP ANY AMMUNITION.**
- Enclose a letter which includes your full name and address (no P.O. Boxes, please), daytime telephone number, e-mail address, the serial number of the firearm, and details of the problem experienced (stating the brand and type of ammunition used when the problem occurred) or work desired.
- Record the serial number before shipping, in case you wish to check on the repair status of your firearm.

## CONTACT AND SHIPPING INFORMATION CONTINUED

- Please remove all custom parts and accessories, such as stocks, special sights and scopes, or slings from your firearm before returning.
- Place the firearm in its original case or in a similarly secure container and pack it securely.
- The package must NOT bear any markings which indicate the identity of the contents.
- It is most important that you comply with federal, state, and local laws and regulations. The following guidelines are meant to help, but you must seek assistance from the appropriate authorities if necessary.
- If your firearm must be replaced, it may be necessary to ship the replacement to a dealer rather than directly to you. You will be requested to furnish a signed FFL (Federal Firearms License) from your dealer in such an instance.
- Warranty repair work will begin upon receipt and examination of the firearm. In the case of repairs or work not covered by the warranty, a quotation covering the cost of the work plus round trip transportation charges will be sent to you. Repairs or modification will be scheduled upon receipt of payment.
- A parts list can be obtained by contacting Smith & Wesson® Customer Service.



**WARNING: YOU MAY PURCHASE ACCESSORIES FOR YOUR SMITH & WESSON® FIREARM. YOU MUST HAVE SOME OF THESE PARTS INSTALLED BY A GUNSMITH QUALIFIED TO PERFORM SERVICE ON SMITH & WESSON® FIREARMS. YOU MUST NEVER ATTEMPT TO MODIFY YOUR FIREARM OR INSTALL REPLACEMENT PARTS IN YOUR FIREARM. ALWAYS USE A QUALIFIED SMITH & WESSON® GUNSMITH EVEN IF THE REPAIR SEEMS SIMPLE.**





---

## CUSTOM SERVICE

---

- We understand that Smith & Wesson® gun owners may want to enhance their guns with custom gunsmithing, refinishing or accessories. Our gunsmiths offer specialized services and exclusive products to enhance your shooting experience.
- Accessories for your Smith & Wesson® firearm are available from your local Smith & Wesson® Stocking Dealer, or directly from Smith & Wesson.
- Contact the Customer Service Department at 1-800-331-0852 extension 4125 for information about these services.

When ordering directly from the factory, please provide the following information:

- Model Number
  - Dash Number
  - Serial Number
  - Approximate date of purchase
  - Complete Return Address
  - VISA/Discover/MasterCard Number & Expiration Date
  - For Foreign Orders Only, Fax Number or E-mail Address
- 
- 



---

## PATENT INFORMATION

---

- This product may be covered by one or more patents.  
Visit [www.smith-wesson.com](http://www.smith-wesson.com) for virtual patent information.

---

## INTERNATIONAL WARRANTY CENTERS

### For Owners Outside The United States

---

**NOTE:** Addresses and contact information for International Warranty Centers is available on the Smith & Wesson® website at [www.smith-wesson.com](http://www.smith-wesson.com) or by calling Customer Service toll-free at 1-800-331-0852 ext 4125.

This handgun is not equipped with a device that fully blocks use by unauthorized users. More than 200,000 firearms like this one are stolen from their owners every year in the United States. In addition, there are more than a thousand suicides each year by younger children and teenagers who get access to firearms. Hundreds more die from accidental discharge. It is likely that many more children sustain serious wounds or inflict such wounds accidentally on others. In order to limit the chance of such misuse, it is imperative that you keep this firearm locked in a secure place and take other steps necessary to limit the possibility of theft or accident. Failure to take reasonable preventative steps may result in innocent lives being lost, and in some circumstances may result in your liability for these deaths.

The certification below is required only for handguns sold in the United States with a barrel length shorter than 3".

Smith & Wesson Inc. hereby certifies average accuracy test results for all new handguns with a barrel shorter than 3" as follows:

7 yards	14 yards	21 yards
1.7"	3.9"	6.3"

This certification is based on tests conducted by Smith & Wesson Inc. using a fixed handgun rest and firing ammunition manufactured by a member of the Shooting Arms and Ammunition Manufacturers Institute (SAAMI) as defined in ANSI/SAAMI Z299.3-1993.

This certification represents actual tests based on several handguns, selected at random. Your particular handgun may have accuracy better than the results stated in this certification.

## BATTERY WARNINGS



**WARNING: IF A BATTERY OPERATED ACCESSORY OR ATTACHMENT (I.E. LASER, OPTICAL SIGHT OR FLASHLIGHT, ETC.) IS SUPPLIED OR USED WITH THIS FIREARM, THE FOLLOWING WARNINGS AND INSTRUCTIONS MUST BE ADHERED TO.**



**WARNING: KEEP BATTERIES AWAY FROM CHILDREN. THERE IS A CHEMICAL BURN HAZARD ASSOCIATED WITH BATTERIES.**



**WARNING: IF A NEW OR USED LITHIUM BUTTON/COIN CELL BATTERY IS SWALLOWED OR ENTERS THE BODY, IT CAN CAUSE SEVERE INTERNAL BURNS AND CAN LEAD TO DEATH IN AS LITTLE AS 2 HOURS. ALWAYS COMPLETELY SECURE THE BATTERY COMPARTMENT. IF THE BATTERY COMPARTMENT DOES NOT CLOSE SECURELY, STOP USING THE PRODUCT, REMOVE THE BATTERIES, AND KEEP IT AWAY FROM CHILDREN. IF YOU THINK BATTERIES MIGHT HAVE BEEN SWALLOWED OR PLACED INSIDE ANY PART OF THE BODY, SEEK IMMEDIATE MEDICAL ATTENTION.**

- When used correctly, batteries provide a safe and dependable source of portable power. However, misuse or abuse may result in leakage, fire, or explosion.
- Batteries can explode or leak and cause burns if installed backwards, disassembled, charged, or exposed to water, fire or high temperature.
- Always take care to install your batteries correctly observing the “+” and “-” marks on the battery and the device.
- Always replace the whole set of batteries at one time, taking care not to mix old and new batteries, or batteries of different types.
- Store unused batteries in their original packaging and away from metal objects that may short-circuit them.
- Remove discharged batteries from equipment promptly to avoid possible damage from leakage.
- Never dispose of batteries in fire. (Failure to observe this precaution may result in an explosion.)
- The batteries are supplied in a charged state and are not designed for recharging. Recharging may cause leakage, fire, or explosion.
- The batteries should be disposed of properly, including keeping them away from children.
- Dispose of used batteries immediately. Even used batteries may cause injury.



**Smith & Wesson®**

**EMPOWERING AMERICANS™**



**44 1320000**

Smith & Wesson®

2100 Roosevelt Avenue • Springfield, MA 01104

[www.smith-wesson.com](http://www.smith-wesson.com)

**p/n 441320000**

**REV:SD&SDVE\_120721**

**48**