



 **TAURUS™**

TCP 738™

TCP 738™

WITH WINGS

INSTRUCTION MANUAL

GENERAL SAFETY, OPERATING INSTRUCTIONS AND LIMITED WARRANTY

READ CAREFULLY BEFORE USING YOUR FIREARM

Important: Keep this manual with your firearm.

The information contained in this manual is useful, both for beginners and experienced shooters. In addition to important information about functioning, cleaning and care of the gun, the manual contains instructions that may be very helpful in shooting properly. The most important rule of safe gun handling is always keep the muzzle pointed in a safe direction!



TCP 738™



**TCP 738™
WITH WINGS**

TaurusUSA.com



[/TaurusUSA](https://www.facebook.com/TaurusUSA)



[@taurususa](https://twitter.com/taurususa)



[/TaurusUSA](https://www.instagram.com/TaurusUSA)

- Available in 380 Auto
- Matte black, matte stainless or black stainless slide
- The lightest Taurus® pistol at only 10 ounces
- Loaded chamber indicator for added safety
- Low-profile fixed sights
- Unique tread pattern on slide for positive pull/functioning
- Generously sized trigger guard for quick, intuitive access
- DAO trigger
- Taurus Security System®

CONTENTS

| | |
|------------------------------|----|
| Firearms Safety | 6 |
| Get To Know Your Pistol..... | 12 |
| Ammunition | 17 |
| Operating Instructions..... | 21 |
| Disassembly | 26 |
| Assembly | 29 |
| Care and Maintenance..... | 31 |
| Exploded View..... | 32 |
| Taurus® Service Policy..... | 36 |





WARNING

The safety warnings in this booklet are important. By understanding the dangers inherent in the use of any firearm, and by taking the precautions described herein, you can safely enjoy your Taurus® firearm. Failure to follow any of these warnings may result in serious injury to you or others, as well as severe damage to the firearm or other property.

NOTES

SIGNAL WORDS AS DEFINED BY ANSI Z535.6 AND Z535.4 STANDARDS.

| | |
|--|--|
|  DANGER | DANGER indicates a hazardous situation which, if not avoided, will result in death or serious injury. |
|  WARNING | WARNING indicates a hazardous situation which, if not avoided, could result in death or serious injury. |
|  CAUTION | CAUTION indicates a hazardous situation which, if not avoided, could result in minor or moderate injury. |
| NOTICE | NOTICE is used to address practices not related to physical injury. |

Intentionally left blank

FIREARMS SAFETY

WARNING

When a firearm discharges, the bullet or shot can strike a person, resulting in death or serious bodily injury.

The three basic keys to safe handling of firearms:

- 1. KEEP YOUR FINGER OFF THE TRIGGER UNTIL YOU ARE READY TO FIRE.** If you maintain good trigger discipline, it is extremely unlikely the firearm will fire.
- 2. KEEP THE MUZZLE POINTED IN A SAFE DIRECTION.** Even if the firearm discharges, if the muzzle is pointed in a safe direction, no one will be injured.
- 3. NEVER TRUST ANY SAFETY MECHANISM.** If you adopt the attitude that you will not trust any safety mechanism, you will be vigilant about keeping your finger off the trigger and keeping the muzzle pointed in a safe direction.

WARNING - KNOW YOUR TARGET

Never fire at targets at close range. Ricochets can and do cause death or serious bodily injury. What constitutes "close range" depends on many factors including target material, bullet caliber and angle of impact.

KNOW WHAT IS BEHIND YOUR TARGET. Unless you are shooting into a bullet trap designed to capture the type of ammunition you are firing, projectiles may pass through the target and strike anyone or anything beyond. Bullets can travel miles.

ALWAYS WEAR HEARING PROTECTION. Firearms are loud. The sound they generate is greater indoors. Repeated exposure to loud noises can cause deafness. Hearing protection is rated by decibel reduction. Look for "dB" reduction of 30 or more when purchasing hearing protection. Modern hearing protection can allow normal hearing until the sound from the discharge reaches the ear. Layering hearing protection, for example, wearing 30db rated foam plugs inside or 20db rated ear muffs, significant protection can be achieved.

ALWAYS WEAR EYE PROTECTION. In normal operation, firearms emit hot high-velocity gases, particles and metal. These materials flying into your eye can cause blindness. Protect your vision with proper eye protection. Any eye protection may be better than none, but look for ANSI Z87.1-2003 certified eyewear for the best protection.

NEVER HANDLE FIREARMS WHILE UNDER THE INFLUENCE OF DRUGS OR ALCOHOL. Firearms are dangerous. Handling firearms while impaired by drugs or alcohol is foolhardy and may result in serious injury or death. This warning includes prescription drugs that contain a warning about using machinery or driving while taking the medication.

MODIFIED FIREARMS ARE DANGEROUS, AND USE CAN RESULT IN SERIOUS INJURY OR DEATH. "Trigger jobs," polishing original components or installing aftermarket parts can cause a firearm to function in ways different than intended. Some such work may also be illegal.

DAMAGED FIREARMS ARE DANGEROUS, AND USE CAN RESULT IN SERIOUS INJURY OR DEATH. Repairs should always be made by a qualified gunsmith or by a factory-authorized repair site. Work done by those unfamiliar with the design can cause a firearm to function in ways different than intended.

NEVER ATTEMPT TO DISASSEMBLE OR CLEAN A LOADED FIREARM. DOING SO CAN RESULT IN SERIOUS BODILY INJURY OR DEATH. How often have we heard "But it went off while I was cleaning it!" or, "I did not know it was loaded!" or, "It was jammed, and I tried to take it apart!"?

IF A FIREARM GOES OFF, THERE WAS A ROUND OF AMMUNITION IN THE CHAMBER. Period. "Clear" (or empty) the firearm of all ammunition before disassembling or cleaning.

As owner of your new Taurus® firearm, you are responsible for (1) keeping your finger off the trigger, (2) pointing the muzzle in a safe direction, (3) removing the magazine, (4) lock slide to rear and (5) looking in the magazine well and chamber to confirm the pistol is empty. An empty firearm cannot fire.

FIREARMS SAFETY SYSTEMS

Firearms safety is supported by a system. With your pistol, the system is made up of the following:

- 1. You!** Your involvement in safety cannot be overemphasized. No safety component can keep your finger off the trigger and the muzzle pointed in a safe direction. Also, you are the key to never trusting any of the mechanical parts of the safety system.
- 2. Loaded chamber indicator.** When a cartridge is loaded in the chamber, the loaded chamber indicator protrudes from the right side of the slide just behind the ejection port, and its surface can be seen or felt without the need for pulling the slide back to check the chamber.



WARNING

The loaded chamber indicator should never be used as a substitute for visually checking for an empty chamber when “clearing” or emptying a pistol.

- 3. Long, double-action trigger pull.** There is no “manual safety” on your TCP 738™. Like many pistols, the trigger pull is long and is not done accidentally. If the trigger is pulled, the shooter intended to pull the trigger.
- 4. This Manual.** Taurus intends for you to use this manual to learn about your pistol and to help you use your pistol safely. If you use the manual, you will be a long way toward being a knowledgeable and safe firearms owner.
- 5. On Line Resources.** TaurusUSA.com hosts a library of videos concerning safety and related issues. This library is being added to and revised. Please visit the site and take advantage of what is available there as part of your education regarding using your Taurus pistol in a safe fashion.

PISTOL AND REVOLVER SIZE AND SAFETY

The selection of a revolver versus a pistol as well as the size, caliber and magazine capacity of a handgun are personal choices. There are many choices to be made, and there are advantages and disadvantages for each. When selecting a pistol, size has safety implications because of the way pistols are loaded.

Generally speaking, smaller handguns may require more attention to be handled safely than medium or full-size handguns. This is because their small size makes it easier to point the muzzle at your hand or to “sweep” (swing the muzzle across your body) yourself or others in ordinary handling.

When chambering a round, we recommend pulling the slide to the rear by gripping the rear of the slide, with the muzzle pointed straight and away from your body and in a safe direction.

SAFE CARRY CONDITION

“Safe Carry Condition” is the most ready-to-fire condition that the user feels is reasonable under the circumstances. Generally, we believe that Taurus® pistols should be carried with a full magazine and an empty chamber. Under most circumstances, this provides the best balance of readiness and safety. On the plus side, if the chamber is empty, unintended discharges are minimized. However, the slide must be manipulated to load a round in the chamber. In emergency circumstances, this can be difficult to do safely and correctly.

If the user believes that he or she is faced with an increased threat, chambering a round is appropriate. For safety reasons, this should be done beforehand with the muzzle pointed in a safe direction, your finger off the trigger and on the Memory Pad. If equipped, place the manual safety in the “safe” position. How do you know you may be going into a more dangerous situation? That depends. If, for example, you carry cash to deposit after a business closing, this may well qualify. If a domestic partner is actively threatening you, this may qualify as well.

“Safe Carry Condition” is a judgment call and must be made by the user. Some users routinely face greater threats than others. Users must be aware of their situation and circumstances. Errors in judgment can have dire and tragic outcomes if firearms are present.

CARRYING FIREARMS

Carrying a firearm can be dangerous. Carrying a firearm makes it more difficult to control the muzzle and makes it more likely that the firearm can be dropped or bumped causing the firearm to fire.

In almost all circumstances, it is safest to carry a handgun in a holster designed for that specific handgun. Carrying a handgun in a pocket without a specific designed In-Pocket Holster or a trigger shield or in a waist band without a belt clip is always a last choice. Carrying any handgun in a holster that fits the firearm and style of carry should prevent it from accidentally falling and you from losing control of the muzzle.

Except in rare high-threat circumstances, carry your pistol with a full magazine and an empty chamber. If the chamber is empty, the pistol cannot fire.



WARNING - CARRYING

Do not carry your firearm in any way that might let it fall or be bumped. If a firearm falls or is bumped, it may fire.



WARNING - CARRYING

Always review and follow the holster or luggage manufacturer's instructions or the firearm may fall or be bumped and fire.

FIREARMS STORAGE AND GUN LOCKS

How you secure your firearm is a personal choice based on the unique circumstances in your home, business or vehicle and the laws of the state where your firearm is located. Any choice you make about securing your firearms will present advantages and disadvantages. It is up to you to weigh those advantages and disadvantages and choose which security method is best for you and those around you.



WARNING - LOCKING

Never lock a firearm with a round of ammunition in the chamber. Unlocking a loaded firearm makes it more difficult to maintain trigger discipline and to keep the muzzle pointed in a safe direction.



WARNING

Securing your firearm may inhibit access in a defensive situation and may result in injury or death.



WARNING

Failure to secure a firearm may result in injury or death. Properly securing a firearm means storing your firearm unloaded, decocked and securely locked, with all ammunition in a separate location.

GET TO KNOW YOUR PISTOL



TAURUS SECURITY SYSTEM®



LOADED CHAMBER INDICATOR



TAURUS SECURITY SYSTEM®

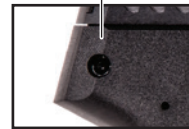

WINGS



LOADED CHAMBER INDICATOR



TCP 738™ WITH WINGS

SPECIFICATIONS

| Model | TCP 738™ | TCP 738™ with Wings |
|-------------------|---|--------------------------------|
| Caliber | 380 Auto | |
| Action | Double Action Only (DAO) | |
| Capacity | 6+1 Rounds | |
| Barrel Length | 2.84" | |
| Overall Length | 5.2" | |
| Overall Height | 3.75" | |
| Overall Width | 0.87" | |
| Sights | Front Sight: Fixed Rear Sight: Fixed | |
| Trigger Pull | (5-7) lbs. | |
| Weight (unloaded) | 10 oz. | |
| Materials | Slide: Stainless Steel or Carbon Steel Barrel: Stainless Steel Grip: Polymer with Metallic Subframe | |
| Safety Devices | Loaded Chamber Indicator, Taurus Security System® | |
| Slide - Finish | Matte Black, Black Stainless Steel and Matte Stainless | Matte Black or Matte Stainless |

THE TAURUS SECURITY SYSTEM®

Your Pistol is equipped with the Taurus Security System (TSS). This system is intended to give the user a "built-in locking system" for the firearm. You may, of course, secure your pistol in any way you see fit.

If you use the TSS:

- Point the pistol in a safe direction and keep your finger off the trigger.
- Remove the magazine and ensure it is empty.
- Pull the slide to the rear and check to see that the chamber is empty.
- Re-insert the empty magazine and pull the trigger to lower the concealed hammer.
- Insert the TSS key in the lock and turn the key clockwise to engage. The lock now protrudes so you can see and feel that it is engaged.

Engagement (secure)

- Insert the **key** into the mechanism and **turn clockwise** until a click is felt or heard.
This engages the TSS.
- The action is locked in place and cannot function.

Disengagement (ready-to-fire)

- To place the pistol in a firing condition, insert the **key** into the mechanism and turn it **counterclockwise** until a click is felt or heard.
- The pistol can now be fired.

NOTICE

Never engage the TSS with the slide in the open rear position or the hammer back in the cocked position. This will result in permanent damage to your pistol.

Unlocking the pistol with the TSS

To deactivate the TSS, rotate the key counterclockwise until the lock button is level with the grip surface.

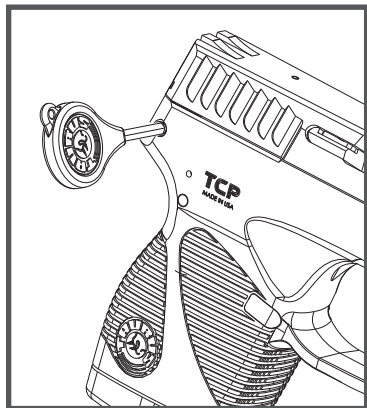

! WARNING

Never attempt to engage the TSS on a Taurus® pistol with a cartridge in the chamber.

AMMUNITION

! WARNING

Using the wrong ammunition in your pistol can result in serious bodily injury and damage to your pistol. Make certain the ammunition you load in the magazine is the same caliber as is marked on the pistol.

! WARNING - AMMUNITION AND INDUSTRY STANDARDS

Use only clean, dry factory-loaded ammunition. Old, damaged, wet or oily ammunition may fire at pressures higher than industry standard, causing injury to you and bystanders or damage to your pistol.

Do not use reloaded ammunition in your pistol. Its firing pressures are unknown and may well exceed industry standard, causing injury to you and bystanders or damage to your pistol.

Odd sounds are signs of trouble. If a round "does not sound right" when it goes off, stop firing right away. A bullet may be stuck in the barrel. Firing the pistol in this condition may cause pressures higher than industry standard, causing injury to you and bystanders or damage to your pistol.

If you hear any odd sounds when firing your pistol, stop firing, clear the pistol and "field strip" (or disassemble) the pistol in accordance with the procedures listed in this manual. Once the barrel is removed from the slide, look down the bore. If you do not see light, there is something stuck in the bore. Do not fire the pistol again, and take the pistol to a competent gunsmith or contact the Taurus® Service department at 800-327-3776.

! WARNING - LEAD EXPOSURE

Discharging firearms in poorly ventilated areas, cleaning firearms or handling ammunition may result in exposure to lead and other substances known to the state of California to cause birth defects, reproductive harm and other serious physical injury. Have adequate ventilation at all times. Wash hands thoroughly after exposure with soap and cold water.

SHOOTING OR CLEANING GUNS MAY EXPOSE YOU TO LEAD

 **WARNING**

“+P” ammunition can be dangerous. There is a detailed discussion about “+P” and “+P+” ammunition on page 20 of this manual. Until you have read that information, do not fire any ammunition marked “+P” in your pistol.

 **WARNING**

Never fire ammunition marked “+P+” in your pistol. It does not comply with industry standards as to chamber pressures.

 **WARNING**

It is DANGEROUS to fire “+P+” ammunition in any Taurus® firearm, and doing so may result in serious bodily injury or death. The Sporting Arms and Ammunition Manufacturers Institute (SAAMI) does not recognize any “+P+” ammunition at all. These loads operate at unknown pressures.

There are only four calibers that can carry a “+P” rating from SAAMI. They are 38 Special +P, 9mm Luger +P, 38 Super Automatic and 45 Automatic +P. There are no other SAAMI approved “+P” loads. Any ammunition in any other caliber marked “+P” is not SAAMI compliant, may be dangerous and should not be used.

Only fire SAAMI rated Plus P (“+P”) ammunition in Taurus® models designated by Taurus for +P use as listed below. **Firing +P ammunition in other Taurus products may be dangerous and can result in serious bodily injury or death.**

Model 85 small-frame revolver in 38 Special.

Model 850 small-frame revolver in 38 Special.

Model 851 small-frame revolver in 38 Special.

Model 85 Polymer small-frame revolver in 38 Special.

Model 82 medium-frame revolver in 38 Special.

Model 817 compact frame (tracker) revolver in 38 Special.

All firearms chambered in 38 Super Automatic.

All firearms chambered in 45 Automatic (ACP).

All firearms chambered in 9mm Luger.

NOTICE

Even if your Taurus® firearm is rated for Plus-P (“+P”) ammunition, such ammunition generates pressures significantly in excess of the pressures associated with standard ammunition. Such pressures may affect the useful life of the firearm or exceed the margin of safety built into many firearms. Unless you need +P ammunition, do not use it, particularly for practice.

FIREARMS ARE NOT ALL ALIKE

Many makes and models of firearms might LOOK nearly the same. However, they differ widely in design, operation, and in the location and function of various controls. You may access the Taurus® website at TaurusUSA.com to view and print manuals.

“JAMS”

SOMETIMES A CARTRIDGE OR SHELL CASE MAY BECOME “JAMMED” OR STUCK IN THE PISTOL. TO CLEAR THE JAM, (1) POINT THE MUZZLE IN A SAFE DIRECTION, (2) KEEP YOUR FINGER OFF THE TRIGGER AND ON THE MEMORY PAD, (3) REMOVE THE MAGAZINE, THEN (4) PULL BACK THE SLIDE AND LOCK IT TO THE REAR. THE JAMMED CARTRIDGE OR CASE CAN NOW BE REMOVED BY SHAKING OR PICKING IT OUT.



WARNING - FIRING

The slide opens and shuts quickly while firing. Keep face and hands away from rear of slide. Hot brass is ejected quickly and can burn you. Always wear shooting glasses, hat with brim, and hearing protection.



WARNING - ANY GUN MAY FIRE IF DROPPED

If dropped or struck, the pistol may fire.



WARNING

If dropped or struck the firearm should be inspected by a trained armorer/gunsmith for a complete function check. While the firearm was dropped or struck, mechanisms, including automatic safeties, may not function as intended resulting in accidental death or serious injury.

OPERATING INSTRUCTIONS - TCP 738™

The TCP 738™ has a concealed hammer firing mechanism. It operates as a conventional double-action system. You must pull the trigger all the way to the rear every time you wish to fire the pistol.

To load and fire your pistol:

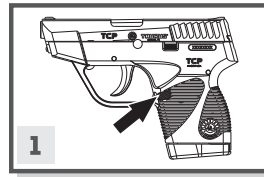

1. To remove the magazine, press the **magazine release button**, located near the **trigger guard**, with your thumb.

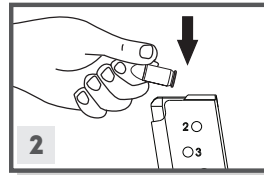

2. To load the magazine, hold the **magazine** with one of your hands and with the other one insert the cartridges one at a time, pressing them down and to the rear.

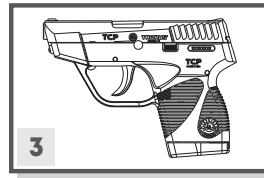

3. Insert the **magazine** into the pistol until it is held by the **magazine catch**. If the **magazine** is not correctly inserted into the pistol, it can fall out.

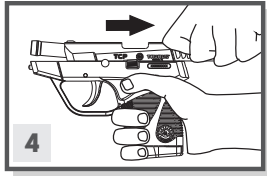

4. Hold the pistol with one hand keeping your finger away from the trigger and on the **memory pad**. With the other hand pull the **slide** backwards to its limit and release it. The slide will go forward under **recoil spring** pressure and will insert one cartridge in the chamber.

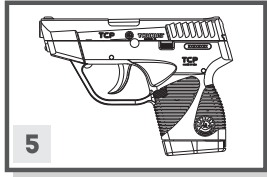

5. The pistol is now cocked and ready to fire by pulling the trigger.

6. Aim the pistol with the low-profile fixed sights. To fire, pull the trigger smoothly and fully to the rear.

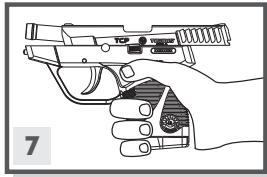

7. After firing, the slide will “recoil” (come back toward you) and eject the empty cartridge case and quickly feed another cartridge into the chamber. The pistol will be ready to fire again. After the last round is out of the magazine, the slide will remain in the open position. In order to make the slide return to its forward position, with the magazine removed, pull the slide slightly to the rear and release the slide.

WARNING

Taurus TCP 738™ pistols do not have a magazine disconnect “safety”. They are capable of firing with the magazine removed.

OPERATING INSTRUCTIONS - TCP 738™ WITH WINGS

The TCP 738™ with wings has a concealed hammer firing mechanism. It operates as a conventional double-action system. You must pull the trigger all the way to the rear every time you wish to fire the pistol.

To load and fire your pistol:

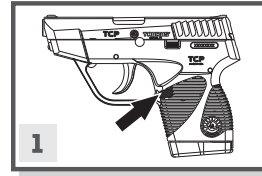

1. Remove the magazine by pressing the magazine release button, located on the grip, with your thumb.

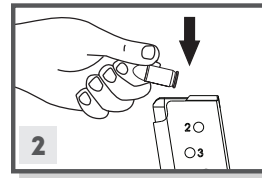

2. Hold the magazine in one hand and insert cartridges, one at a time, bullet forward, by pressing them down and to the rear.

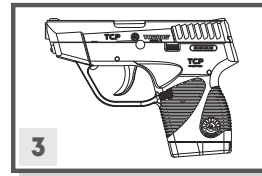

3. Insert the magazine into the pistol until it is held by the magazine catch. If the magazine is not correctly inserted into the pistol, it can fall out.

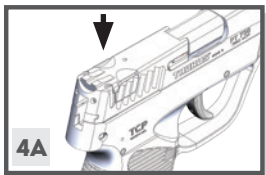

4. On top of the slide (on either side), there are reliefs to help open the wings easily with your fingertips (4A). Use your fingertips to pull the wings open as shown (4B). With a firm hold on the pistol grip with one hand (blue arrow), place the slide between your index and middle fingers with your other hand; with those fingers pulling back against the inside face of the wings to manipulate the slide action (4C).

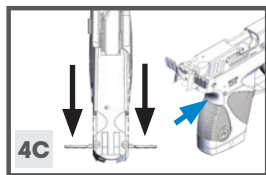
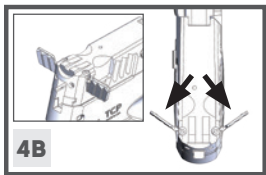

5. Manually close the wings by rotating them inward against the slide back into the relief pocket before firing (5A). The pistol is now cocked and ready to fire by pulling the trigger (5B).

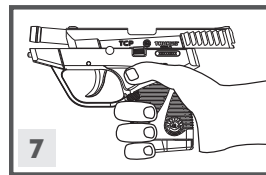
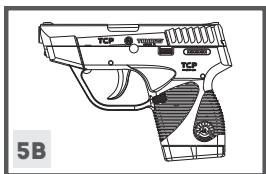
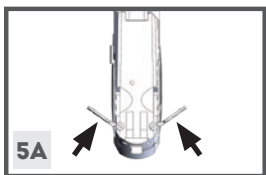

6. Aim the pistol with the low-profile fixed sights. To fire, pull the trigger smoothly and fully to the rear.

7. After firing, the slide will “recoil” (come back toward you) and eject the empty cartridge case and quickly feed another cartridge into the chamber. The pistol will be ready to fire again. After the last round is out of the magazine, the slide will remain in the open position. In order to make the slide return to its forward position, with the magazine removed, pull the slide slightly to the rear and release the slide.

WARNING - FIRING

The slide opens and shuts quickly while firing. Keep face and hands away from rear of slide. Hot brass is ejected quickly and can burn you. Always wear shooting glasses, hat with brim, and hearing protection.

WARNING - ANY GUN MAY FIRE IF DROPPED

If dropped or struck, the pistol may fire.

DISASSEMBLY

WARNING

Always wear eye protection that is specified for use with firearms (ANSI Z87.1+) every time you handle your firearm for cleaning and maintenance.

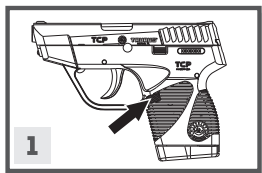

1. Remove the magazine by pressing the magazine release.

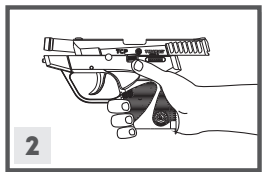

2. Pull **slide** to the rear and lock in the open position by pushing upward on the **slide catch lever**.

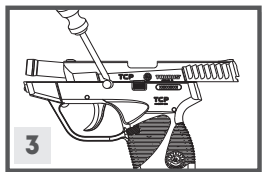

3. Loosen the **disassembly pin** using a screwdriver or other flat tool. Remove the **disassembly pin** completely. **While removing the disassembly pin, make sure that the slide won't be damaged (scratched).** Tool pictured is not included.

WARNING

After removing the magazine, always check the chamber and make sure it is empty.

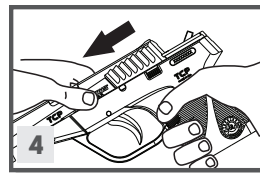

4. Carefully release **slide catch**, pull **slide** forward off of the **frame**.

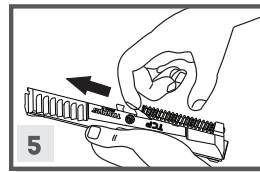

5. Compress the **recoil spring** slightly from its position on the bottom of the **barrel**. Lift and remove it carefully.

WARNING

Take care to prevent the forcible ejection of the recoil spring guide and compressed recoil spring assembly.

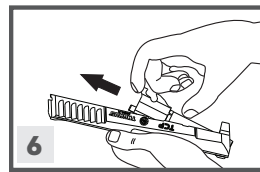

6. Remove the **barrel** from the **slide** by pulling to the front and up.

WARNING

No further disassembly is recommended unless done by a skilled gunsmith.

DISASSEMBLING YOUR MAGAZINE

1. Use a **punch** to press the **magazine plate** down, then **pull** the magazine bottom out of the magazine body.

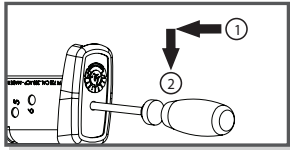

WARNING

Take care to prevent the forcible ejection of the magazine spring plate and compressed magazine spring.

2. Withdraw the magazine spring plate and magazine spring from the magazine body. Turn the magazine upside down and remove the magazine follower.

3. Assemble in reverse order.

WARNING

Always wear eye protection that is specified for use with firearms (ANSI Z87.1+) every time you handle your firearm for cleaning and maintenance.

ASSEMBLY

In order to assemble the pistol, proceed by reversing the disassembling procedure while observing the following details:

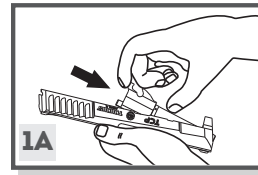

1. Replace the **barrel** in the **slide** by pushing it to the rearward position (1A). Insert the **recoil spring/guide rod** sub assembly into the **slide** over the **barrel**, compressing the spring slightly to get it into position (1B).

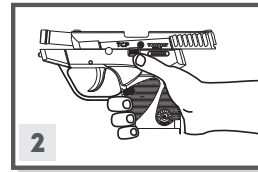
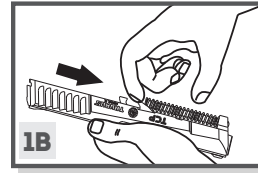

2. The **slide** should be mounted on the frame and pulled fully to the rear, and the **slide catch** must be moved upward to hold the **slide** to the rear.

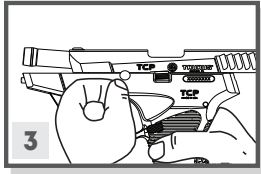

3. When reinstalling the DISASSEMBLY PIN, you must make sure that the **barrel** is fully forward in the **slide**. The **pin** must be pushed through the **frame** and the mating portion of the bottom of the **barrel**. Once these parts have been lined up, and you gently push the latch in, a click will be heard indicating that the PIN is secured in place.

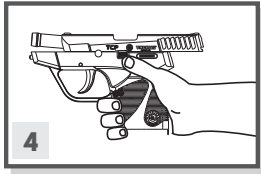

4. The **slide catch** can then be depressed which allows the **slide** to go forward.

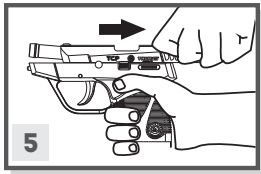

5. You should cycle the slide several times, with no magazine inserted and no rounds in the chamber, to ensure that the barrel/slide/frame relationship is correct.

CARE AND MAINTENANCE

The firearm may be cleaned and lubricated under normal conditions with the disassembly steps described in pages 26-27.

In order to keep a firearm safe to use, it must be kept clean and covered with a light film of good quality oil to prevent corrosion. The barrel bore should be cleaned and left free of debris.

For normal cleaning, rub the pistol with a lightly oiled cloth. In the same way, proceed with the bore of the barrel. Excess oil should be removed. Dust should be removed from all crevices with a small clean brush.

Please note that a firearm with laser should not be cleaned in a well or supersonic machine that submerges the firearm as this can damage the laser system.

WARNING

Before cleaning, (1) point the muzzle in a safe direction, (2) keep your finger off the trigger, (3) remove the magazine, then (4) pull back the slide and lock it to the rear.

Firearm should always be clear (or empty) of all ammunition before disassembling or cleaning.

EXPLODED VIEW - TCP 738™

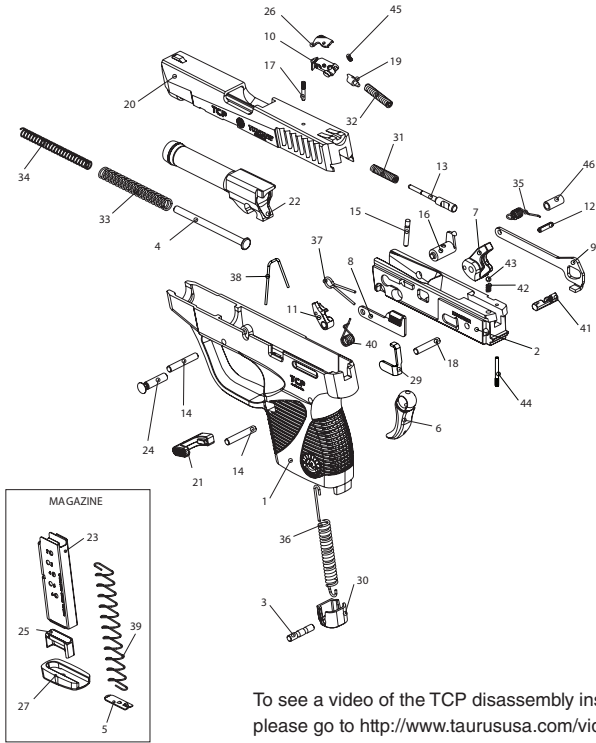

To see a video of the TCP disassembly instructions, please go to http://www.taurususa.com/video_738_tcp.cfm.

PART LIST

- | | |
|-----------------------------|--|
| 1 GRIP | 34 RECOIL SPRING INNER |
| 2 FRAME | 35 TRIGGER SPRING |
| 3 HAMMER SPRING PIN | 36 HAMMER SPRING |
| 4 RECOIL SPRING GUIDE | 37 SLIDE RELEASE SPRING/ DISASSEMBLY SPRING |
| 5 MAGAZINE SPRING PLATE | 38 MAGAZINE RELEASE SPRING |
| 6 TRIGGER | 39 MAGAZINE SPRING |
| 7 HAMMER | 40 SEAR SPRING |
| 8 SLIDE LATCH | 41 KEY LOCK |
| 9 TRIGGER BAR | 42 KEY LOCK SPRING |
| 10 EXTRACTOR | 43 KEY LOCK BALL |
| 11 SEAR | 44 KEY LOCK PIN |
| 12 BARREL SPRING PIN | 45 LOADED CHAMBER INDICATOR SPRING |
| 13 FIRING PIN | 46 FRAME BUSHING |
| 14 GRIP PIN | |
| 14 SEAR PIN | |
| 15 TRIGGER PIVOT PIN | |
| 16 TRIGGER PIVOT | |
| 17 FIRING PIN GUIDE | |
| 18 HAMMER PIN | |
| 19 EXTRACTOR SPRING PIN | |
| 20 SLIDE | |
| 21 MAGAZINE RELEASE | |
| 22 BARREL | |
| 23 MAGAZINE BODY | |
| 24 DISASSEMBLY SPRING | |
| 25 MAGAZINE FOLLOWER | |
| 26 LOADED CHAMBER INDICATOR | |
| 27 MAGAZINE BOTTOM | |
| 29 EJECTOR | |
| 30 GRIP CAP | |
| 31 FIRING PIN SPRING | |
| 32 EXTRACTOR SPRING | |
| 33 RECOIL SPRING OUTER | |

EXPLODED VIEW - TCP 738™ WITH WINGS

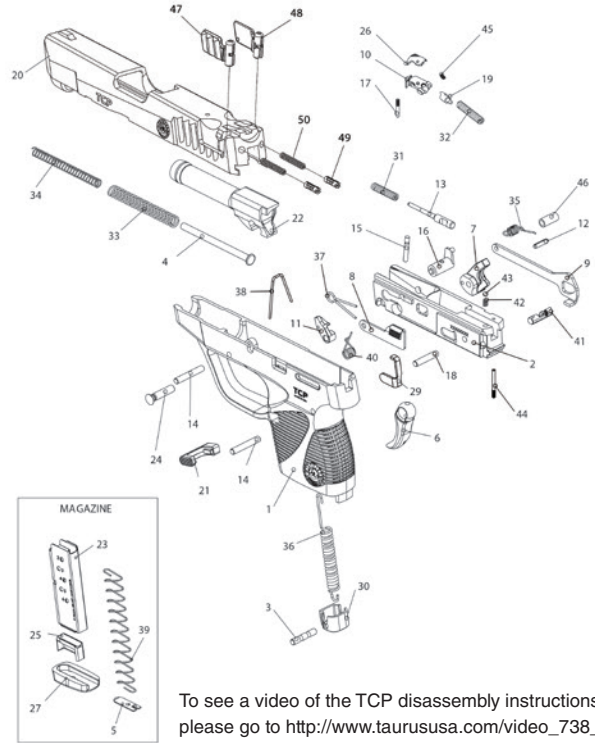

To see a video of the TCP disassembly instructions, please go to http://www.taurususa.com/video_738_tcp.cfm.

PART LIST

- | | |
|-----------------------------|--|
| 1 GRIP | 34 RECOIL SPRING INNER |
| 2 FRAME | 35 TRIGGER SPRING |
| 3 HAMMER SPRING PIN | 36 HAMMER SPRING |
| 4 RECOIL SPRING GUIDE | 37 SLIDE RELEASE SPRING/ DISASSEMBLY SPRING |
| 5 MAGAZINE SPRING PLATE | 38 MAGAZINE RELEASE SPRING |
| 6 TRIGGER | 39 MAGAZINE SPRING |
| 7 HAMMER | 40 SEAR SPRING |
| 8 SLIDE LATCH | 41 KEY LOCK |
| 9 TRIGGER BAR | 42 KEY LOCK SPRING |
| 10 EXTRACTOR | 43 KEY LOCK BALL |
| 11 SEAR | 44 KEY LOCK PIN |
| 12 BARREL SPRING PIN | 45 LOADED CHAMBER INDICATOR SPRING |
| 13 FIRING PIN | 46 FRAME BUSHING |
| 14 GRIP PIN | 47 LEFT WING |
| 14 SEAR PIN | 48 RIGHT WING |
| 15 TRIGGER PIVOT PIN | 49 PLUNGER |
| 16 TRIGGER PIVOT | 50 SPRING |
| 17 FIRING PIN GUIDE | |
| 18 HAMMER PIN | |
| 19 EXTRACTOR SPRING PIN | |
| 20 SLIDE | |
| 21 MAGAZINE RELEASE | |
| 22 BARREL | |
| 23 MAGAZINE BODY | |
| 24 DISASSEMBLY SPRING | |
| 25 MAGAZINE FOLLOWER | |
| 26 LOADED CHAMBER INDICATOR | |
| 27 MAGAZINE BOTTOM | |
| 29 EJECTOR | |
| 30 GRIP CAP | |
| 31 FIRING PIN SPRING | |
| 32 EXTRACTOR SPRING | |
| 33 RECOIL SPRING OUTER | |

TAURUS® SERVICE POLICY

Should your firearm require adjustment or repair contact our Customer Care department at 800-327-3776.

Please follow these suggestions to expedite service in the United States to return any firearm to us for adjustment or repair.

1. Federal law permits you to return your firearm to the manufacturer for service via common carriers. However, state and local firearms laws vary greatly; you should consult your local prosecuting attorney regarding any restrictive laws in your jurisdiction regarding your shipment or receipt of firearms. With the above in mind, it is strongly recommended that any firearm sent to us for repair be sent through a federally licensed dealer.

2. All firearms must be shipped to us prepaid. **WE WILL NOT ACCEPT COLLECT SHIPMENTS.**

3. Be sure to enclose a letter stating your name, address and telephone number as well as serial number, caliber and barrel length of your firearm. Also state the nature of trouble experienced or work required. Merely stating “defective” or “repair as necessary” is inadequate information. Be specific and enclose copies of any previous correspondence. Work (other than warranty repair) will bear minimum labor charge of \$35.00.

4. **FIREARMS MUST BE SHIPPED UNLOADED.** Double check the chambers of your firearm before shipping. If firearms are sent to Taurus in a loaded condition, we are required by law to notify the Federal authorities.

5. **DO NOT** include telescopic sights, custom grips, holsters, or other accessories with any firearm shipped to us.

PARTS

Firearms require periodic maintenance, inspection, adjustment and repair. If your pistol has a malfunction, be safe. Stop firing, “clear” and unload the pistol and take it to a competent gunsmith. Before shooting it again, contact our Customer Care department if you have any questions.

If water, sand, or other foreign matter gets in your pistol, field strip it (see pages 26-27) and thoroughly clean it. Failure to keep your firearm clean and in proper working order can be dangerous.

Our Customer Care department maintains a full stock of replacement parts for current Taurus firearms. Even though most gunsmiths have the knowledge, training and ability to make the necessary repairs to your firearm, the skill and workmanship of any particular gunsmith is totally beyond our control. Should your firearm require service, return it to Taurus Customer Care department. Please refer to Repair Policy on the TaurusUSA.com website for information on the policy and shipping, or call 800-327-3776.

Remember, unauthorized adjustments or parts replacement can void your warranty. If you choose to have someone else do the required work, the purchaser and/or installer of parts must accept full responsibility for the correct adjustment and function of the firearm.

NOTES

IMPORTANT DO NOT DISCARD

KEEP THIS MANUAL WITH THE FIREARM
UPON CHANGE OF OWNERSHIP.

**TAURUS INTERNATIONAL
MANUFACTURING, INC.**
16175 NW 49th Avenue
Miami, Florida 33014
Telephone: 305-624-1115
Fax: 305-624-1126

TAURUSUSA.COM

MKG50017 REV.5

