

# INSTRUCTION MANUAL FOR



## RUGER® SECURITY-9®



– Rugged, Reliable Firearms® –



**READ THE INSTRUCTIONS AND  
WARNINGS IN THIS MANUAL CAREFULLY  
BEFORE USING THIS FIREARM**

© 2022 Sturm, Ruger & Co., Inc.

This manual may not be reproduced in whole or in part without the express written permission of Sturm, Ruger & Co., Inc.

**For Service on This Model Please Call:  
(336) 949-5200 (See p. 34)**

THIS INSTRUCTION MANUAL SHOULD ALWAYS ACCOMPANY THIS FIREARM AND BE TRANSFERRED WITH IT UPON CHANGE OF OWNERSHIP, OR WHEN THE FIREARM IS LOANED OR PRESENTED TO ANOTHER PERSON

## State-By-State Warnings

Certain states require by law that their own specified warning notices in larger-than-normal type be conspicuously included by the manufacturer, distributor or retailer with firearms sold in that state.

Sturm, Ruger & Co., Inc. sells its products in compliance with applicable laws and regulations. Because our products may be sold in these states, we include the following:

### **California:**

#### **WARNING**

“Firearms must be handled responsibly and securely stored to prevent access by children and other unauthorized users. California has strict laws pertaining to firearms, and you may be fined or imprisoned if you fail to comply with them. Visit the Web site of the California Attorney General at <https://oag.ca.gov/firearms> for information on firearm laws applicable to you and how you can comply.

Prevent child access by always keeping guns locked away and unloaded when not in use. If you keep a loaded firearm where a child obtains and improperly uses it, you may be fined or sent to prison.

If you or someone you know is contemplating suicide, please call the national suicide prevention lifeline at 1-800-273-TALK (8255).”

#### **ADVERTENCIA**

“Las armas de fuego deben manipularse de manera responsable y segura para evitar el acceso de niños y otros usuarios no autorizados. California tiene leyes estrictas relacionadas con armas de fuego, y usted puede ser multado o encarcelado si no las cumple. Visite el sitio web del Procurador General de California en <https://oag.ca.gov/firearms> para obtener información sobre las leyes de armas de fuego que le son aplicables y cómo puede cumplirlas.

A los niños los atraen las armas de fuego y las pueden hacer funcionar. Ellos pueden causarse lesiones graves y la muerte. Evite que los niños tengan acceso a las armas de fuego guardándolas siempre con llave y descargadas cuando no las esté utilizando. Si usted tiene un arma de fuego cargada en un lugar en que un niño tiene acceso a ella y la usa indebidamente, le pueden dar una multa o enviarlo a la cárcel.

Si usted o alguien que conoce está pensando en suicidarse, llame a la línea nacional de prevención del suicidio al 1-800-273-TALK (8255).”

## **Connecticut:**

“UNLAWFUL STORAGE OF A LOADED FIREARM MAY RESULT IN IMPRISONMENT OR FINE.”

## **Florida:**

“IT IS UNLAWFUL, AND PUNISHABLE BY IMPRISONMENT AND FINE, FOR ANY ADULT TO STORE OR LEAVE A FIREARM IN ANY PLACE WITHIN THE REACH OR EASY ACCESS OF A MINOR UNDER 18 YEARS OF AGE OR TO KNOWINGLY SELL OR OTHERWISE TRANSFER OWNERSHIP OR POSSESSION OF A FIREARM TO A MINOR OR A PERSON OF UNSOUND MIND.”

## **Maine:**

“ENDANGERING THE WELFARE OF A CHILD IS A CRIME. IF YOU LEAVE A FIREARM AND AMMUNITION WITHIN EASY ACCESS OF A CHILD, YOU MAY BE SUBJECT TO FINE, IMPRISONMENT OR BOTH. KEEP FIREARMS AND AMMUNITION SEPARATE. KEEP FIREARMS AND AMMUNITION LOCKED UP. USE TRIGGER LOCKS.”

## **Maryland:**

“WARNING: Children can operate firearms which may cause death or serious injury. It is a crime to store or leave a loaded firearm in any location where an individual knew or should have known that an unsupervised minor would gain access to the firearm. Store your firearm responsibly!”

## **Massachusetts:**

“WARNING FROM THE MASSACHUSETTS ATTORNEY GENERAL: This handgun is not equipped with a device that fully blocks use by unauthorized users. More than 200,000 firearms like this one are stolen from their owners every year in the United States. In addition, there are more than a thousand suicides each year by younger children and teenagers who get access to firearms. Hundreds more die from accidental discharge. It is likely that many more children sustain serious wounds, or inflict such wounds accidentally on others. In order to limit the chance of such misuse, it is imperative that you keep this weapon locked in a secure place and take other steps necessary to limit the possibility of theft or accident. Failure to take reasonable preventive steps may result in innocent lives being lost, and in some circumstances may result in your liability for these deaths.”

“IT IS UNLAWFUL TO STORE OR KEEP A FIREARM, RIFLE, SHOTGUN OR MACHINE GUN IN ANY PLACE UNLESS THAT WEAPON IS EQUIPPED WITH A TAMPER-RESISTANT SAFETY DEVICE OR IS STORED OR KEPT IN A SECURELY LOCKED CONTAINER.”

## **New Jersey:**

“IT IS A CRIMINAL OFFENSE TO LEAVE A LOADED FIREARM WITHIN EASY ACCESS OF A MINOR.”

## **New York:**

“THE USE OF A LOCKING DEVICE OR SAFETY LOCK IS ONLY ONE ASPECT OF RESPONSIBLE FIREARM STORAGE. FOR INCREASED SAFETY, FIREARMS SHOULD BE STORED UNLOADED AND LOCKED IN A LOCATION THAT IS BOTH SEPARATE FROM THEIR AMMUNITION AND INACCESSIBLE TO CHILDREN AND UNAUTHORIZED PERSONS.”

**North Carolina:**

“IT IS UNLAWFUL TO STORE OR LEAVE A FIREARM THAT CAN BE DISCHARGED IN A MANNER THAT A REASONABLE PERSON SHOULD KNOW IS ACCESSIBLE TO A MINOR.”

**Texas:**

“IT IS UNLAWFUL TO STORE, TRANSPORT, OR ABANDON AN UNSECURED FIREARM IN A PLACE WHERE CHILDREN ARE LIKELY TO BE AND CAN OBTAIN ACCESS TO THE FIREARM.”

**Wisconsin:**

“IF YOU LEAVE A LOADED FIREARM WITHIN THE REACH OR EASY ACCESS OF A CHILD YOU MAY BE FINED OR IMPRISONED OR BOTH IF THE CHILD IMPROPERLY DISCHARGES, POSSESSES, OR EXHIBITS THE FIREARM.”

\* \* \* \* \*

Please check with your licensed retailer or state police for additional warnings which may be required by local law or regulation. Such regulations change constantly, and local authorities are in the best position to advise you on such legal matters.

**FIREARMS SAFETY IS YOUR RESPONSIBILITY**  
**SAFETY MUST BE THE FIRST AND CONSTANT  
CONSIDERATION OF EVERY PERSON WHO HANDLES  
FIREARMS AND AMMUNITION.**

This instruction manual is designed to assist you in learning how to use and care for your **RUGER® SECURITY-9®** pistol properly. Please contact us if you have any questions.

Only when you are certain you fully understand the manual and can properly carry out its instructions should you practice loading, unloading, etc. with live ammunition. If you have any doubts about your ability to handle or use a particular type of firearm safely, you should seek supervised instruction. Such personalized instruction often is available from local firearm retailers, gun clubs or police departments. If none of these sources can help, visit [nra.org](http://nra.org) or write to the following address:

National Rifle Association  
11250 Waples Mill Road  
Fairfax, VA 22030-7400

The person possessing a firearm has a full-time job. You cannot guess; you cannot forget. You must know how to use your firearm safely. **Do not use any firearm without having a complete understanding of its particular characteristics and safe use.** Remember: There is no such thing as a foolproof firearm.

## TABLE OF CONTENTS

State-By-State Warnings .....	3
Nomenclature .....	9
Locking Device Installation Instructions .....	10
General Information and Mechanical Characteristics .....	12
Ammunition .....	13
Operation of Manual Safety .....	14
To Load and Fire (with magazine) .....	15
To Load and Fire (without magazine) .....	17
To Unload .....	18
To Extract and Eject a Chambered Cartridge .....	19
To Clear a Malfunction (“Jam” or “Misfire”) .....	20
To Minimize Malfunctions (“Jams” or “Misfires”) .....	21
Disassembly .....	21
Reassembly .....	26
Check Your Pistol’s Function .....	27
Front Sight Removal & Installation .....	28
Rear Sight Removal & Installation .....	30
Rear Sight Adjustment .....	31
Magazine Inspection and Care .....	31
Care and Cleaning .....	32
Storage .....	33
Service and Parts Policy .....	34
Shipping Firearms for Repair .....	34
Ordering Parts .....	35
Parts List .....	36
Exploded View .....	37
<b>The Basic Rules of Safe Firearms Handling .....</b>	<b>38</b>
Warranty Information .....	44

“Ruger” is a registered U.S. trademark.

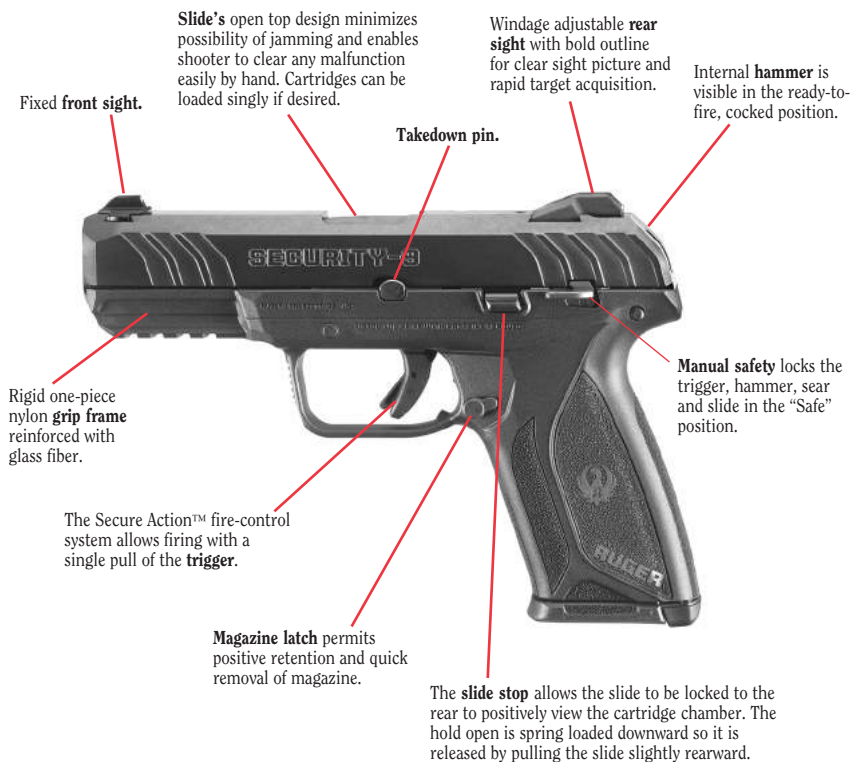


**WARNINGS OF GREAT IMPORTANCE ARE  
FOUND ON THE FOLLOWING PAGES:**

Locking Devices	10	Slide Retraction	19
Alterations	12	Malfunctions	20
Lead Exposure	14	Disassembly	25
Ammunition	14	Lubrication	32
Manual Safety	15	Storage	33
Firing	17	Shipping	34
Handling	17	Parts Purchasers	35
Unloading	18		

**OTHER CAUTIONS AND WARNINGS APPEAR  
THROUGHOUT THE MANUAL.**

# NOMENCLATURE





# LOCKING DEVICE INSTALLATION INSTRUCTIONS



## WARNING – USE OF LOCKING DEVICES



**Do not store keys  
in lock.**

- Always keep your firearm pointed in a safe direction, including when you are installing or removing your locking device.
- Always verify that your firearm is completely **unloaded** before installing your locking device.
- Do **not** install locking devices in the trigger guard; always keep your fingers and locking device outside the trigger guard during device installation and removal.
- Store firearms, ammunition and keys separately and securely, away from children and careless adults; do **not** store your firearm with the keys in the locking device.
- Do not attempt to work the action of your firearm with the locking device in place; this may damage your firearm.
- While locking devices are an important aid to security measures, they are not a substitute for safe firearm handling and proper storage. Remember that any mechanical device can be bypassed with enough time, knowledge, determination and equipment.

**LOCKING DEVICES MUST BE USED  
SAFELY AND RESPONSIBLY**

It is important to use the locking device on your Ruger® firearm when the firearm is stored or immediate use is not planned.

Keep the muzzle pointed in a safe direction and your fingers outside the trigger guard at all times during installation of the locking device!

### **To Install the Factory-Supplied Locking Device:**

1. Remove the magazine from your pistol.
2. Open the action completely, and verify that the firearm is completely unloaded and contains no cartridges or cartridge cases!

To keep the action open during installation of the locking device, hold the pistol firmly and grasp the slide. Retract the slide to its rearmost position briskly to extract and eject any chambered cartridge. Always double check, visually and physically, the chamber, breech-face, and the interior of the frame are clear of any live rounds. When the slide is fully retracted, push upward on the slide stop, then allow the slide to move forward until it comes to rest with the rear projection of the slide stop resting in the notch on the lower left side of the slide.

3. Insert the cable directly in to your pistol as shown in Figure 1.
4. To lock: With the key turned to the farthest clockwise position, insert the loose end of the cable into the lock. Turn the key counterclockwise and remove the key.
5. Once the lock is securely closed, pull firmly on the lock to test the connection and be sure it is locked. **Do not leave or store your firearm with the key in the lock!** Store your locked, unloaded firearm and the key in secure, separate locations, away from ammunition, children, and unauthorized adults.



**Figure 1**

**Correct installation of the lock on a Ruger® Security-9® pistol.**

**FIREARMS ARE DANGEROUS WEAPONS.  
READ THE INSTRUCTIONS AND WARNINGS  
IN THIS MANUAL THOROUGHLY AND  
CAREFULLY BEFORE USING.**

 <b>WARNING - ALTERATIONS</b>	
	This product was designed to function properly in its original condition. Alterations can make it unsafe. Do not alter any part or add or substitute parts or accessories not made or sold by Sturm, Ruger & Co., Inc.
	<b>DO NOT ALTER ANY FIREARM</b>

## GENERAL INFORMATION AND MECHANICAL CHARACTERISTICS

The **RUGER® SECURITY-9®** pistol is a lightweight, compact, Secure Action™, magazine-fed, recoil-operated pistol chambered for the 9MM Luger cartridge. The **SECURITY-9®** pistol incorporates a “link-less” barrel, an alloy steel slide, and a glass fiber reinforced nylon grip with an aluminum insert. The following are features with which **SECURITY-9®** pistol users should be thoroughly familiar:

**Action:** The strong locked breech action of the **RUGER® SECURITY-9®** pistol utilizes a tilting barrel design in which the barrel and slide are locked together at the moment of firing. After firing, the barrel and slide recoil to the rear a short distance while securely locked together. After this initial movement, the barrel is cammed downward from its locked position, permitting full recoil of the slide and the extraction and ejection of the spent cartridge case. Upon return of the slide to its forward position by the recoil spring, the barrel is cammed back upward into its locked position in the slide.

The user of this or any autoloading pistol must always remember that when fired, it automatically reloads and recocks itself, so that simply pulling the trigger will fire the pistol again. Therefore, an autoloading pistol user must be particularly conscious to always keep the pistol pointed in a safe direction.

**Slide stop:** This allows the user to manually lock the slide open. **Note:** when the last shot has been fired and the magazine is empty, the slide stop automatically holds the slide open. If a loaded magazine is inserted in the pistol when the slide is closed and the slide is then retracted fully, the slide stop will not automatically hold open the slide. The user can actuate the slide stop mechanism to hold the slide open at any time by retracting the slide and pushing the slide stop up.

With the magazine removed or a loaded magazine inserted, the slide can be released by pulling rearward slightly on the slide. When the slide is released, it will move forward under pressure from the recoil spring.

The slide stop is held in place by a spring. Therefore, when there is a loaded magazine in place and the pistol is jarred, the slide can fly forward and chamber a cartridge. For this reason and as an essential safety practice, **the user should always be careful to keep fingers away from the trigger, and always keep the pistol pointed in a safe direction.**

**Magazines:** Use only GENUINE RUGER® FACTORY magazines designated for your firearm. The use of incorrect magazines in any pistol will result in malfunctions.

**DAMAGED, NON-STANDARD, OR IMPROPERLY ASSEMBLED MAGAZINES SHOULD NOT BE USED. THEY CAN CAUSE THE PISTOL TO MALFUNCTION.**

## AMMUNITION

The **RUGER® SECURITY-9®** pistols are chambered for the 9mm Luger cartridge. Do not attempt to load any other cartridges into the magazine or chamber of the pistol.

The **RUGER® SECURITY-9®** pistol is compatible with standard factory ammunition loaded to U.S. Industry Standards, including hollow-point loads loaded in brass or aluminum cases. No 9mm ammunition manufactured in accordance with NATO, U.S., SAAMI, or CIP standards is known to be beyond the design limits or known not to function in this pistol.

**Note on the SECURITY-9® pistol: Do not use “+P+” ammunition.**

### AMMUNITION (CARTRIDGES) NOTICE

WE SPECIFICALLY DISCLAIM RESPONSIBILITY FOR ANY DAMAGE OR INJURY WHATSOEVER OCCURRING IN CONNECTION WITH, OR AS A RESULT OF, THE USE IN RUGER® FIREARMS OF FAULTY, OR NON-STANDARD, OR “RE-MANUFACTURED”, OR HAND-LOADED (RELOADED) AMMUNITION, OR OF CARTRIDGES OTHER THAN THOSE FOR WHICH THE FIREARM WAS ORIGINALLY CHAMBERED.



## WARNING - LEAD EXPOSURE



Discharging firearms in poorly ventilated areas, cleaning firearms, or handling ammunition may result in exposure to lead and other substances known to the State of California to cause birth defects, reproductive harm, and other serious physical injury. Have adequate ventilation at all times. Wash hands thoroughly after exposure.

**SHOOTING OR CLEANING FIREARMS  
MAY EXPOSE YOU TO LEAD**



## WARNING - AMMUNITION



Use only new, factory ammunition of the correct caliber.

Death, serious injury, and damage can result from the wrong ammunition, bore obstructions, powder overloads or incorrect cartridge components.

Always wear shooting glasses and hearing protection.

**IMPROPER AMMUNITION  
DESTROYS FIREARMS**

## OPERATION OF MANUAL SAFETY

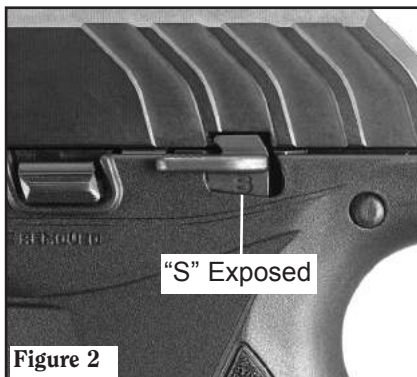
The **SECURITY-9®** pistol is equipped with a manual safety lever.

To engage the manual safety, point the pistol in a safe direction. Move the safety lever upward fully to the “safe” position. **NOTE:** The slide must be fully forward and the internal hammer fully cocked before the safety can be moved upwards. When the safety is moved fully upward to the “safe” position, the red oval on the left side of the frame insert will be fully covered by the safety lever and a letter “S” will be visible. If any red is showing, the safety is not in the “safe” position. Do not attempt to engage the safety while pulling the trigger.

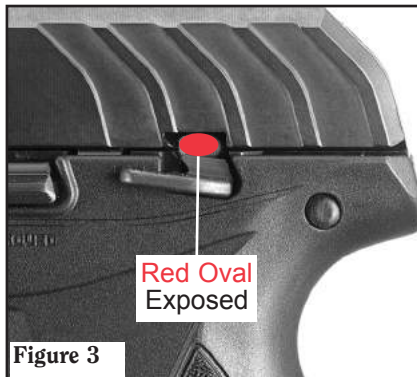
The safety mechanism provides that the trigger cannot be pulled unless the safety is disengaged. The manual safety lever locks the slide shut, ensuring that the pistol will be ready to fire when the safety is disengaged. To disengage the manual safety, point the pistol in a safe direction and push the safety lever fully downward. The red oval signifies that the safety is disengaged and the pistol is ready to fire if the internal hammer is fully cocked.

The safety should be in its “safe” position at all times except when the user is deliberately positioned to fire at a selected target. When the safety is in the “fire” position (safety lever down) the red oval is exposed just above the safety lever. See Figures 2 and 3, below, which illustrate the two positions of the safety.

### “SAFE” POSITION



### “FIRE” POSITION



## WARNING - MANUAL SAFETY



Placing the safety in an intermediate position between “safe” and “fire” can result in the user thinking the pistol is in a safe or fire position when it is not. Pulling the trigger with the safety in an intermediate position may cause the pistol to fire. Therefore, always move the safety fully to its intended position and then check to be sure it is where you want it to be. Unless the red oval is fully covered by the safety lever, the safety is not “ON.” Unless the red oval is fully visible, the pistol is not absolutely ready to fire.

**NEVER PUT SAFETY 1/2 ON**

## TO LOAD AND FIRE (WITH MAGAZINE)

Practice this important aspect of safe gun handling with an unloaded pistol until you can perform each of the steps described below with skill and confidence. **But before you do anything with the pistol, first read completely through this manual.**

1. **Be certain the muzzle is pointed in a safe direction.** (See “The Basic Rules of Safe Firearms Handling,” page 38.)
2. Press the magazine latch and remove the magazine from the frame.

**NOTE:** The magazine is designed to fall free of the frame of its own weight when unloaded and the pistol is held in the normal firing position, but you should always prevent possible damage to the magazine by not letting it drop to the ground unless rapid reloading is absolutely necessary.



3. Place fifteen (15) or fewer 9mm Luger cartridges into the standard capacity magazine from the top. (**NOTE:** Some states prohibit the use of magazines with a capacity greater than ten (10) rounds.)
4. Insert the magazine into the frame, taking care that the magazine is locked in place by the magazine latch. Slamming the magazine into the frame forcibly is not necessary.
5. Hold the pistol firmly in the shooting hand but **do not touch the trigger. Keep the pistol pointed in a safe direction.** With the other hand grasp the top of the slide and pull the slide to the rear as far as it will go (see Figure 4, below). Use care to not place any part of your hand in front of the muzzle or in close contact with the slide as it moves forward (see “Slide Retraction Warning,” p. 19). When released, the slide will fly forward to strip the top cartridge from the magazine and chamber it. The hammer is automatically cocked by the motion of the slide.



**WARNING:** The pistol is ready for instant use when the trigger is pulled once the slide moves fully forward. Be careful!



**Figure 4**  
Retracting the Slide

6. **If the pistol is not to be used immediately, the magazine should be removed and the chamber unloaded.** (See p. 18 for unloading instructions.)
7. **The pistol is ready for instant use.** The first shot can be fired by pulling the trigger all the way to the rear, which releases the hammer and then fires the pistol. Subsequent shots are fired in the same way by releasing and then pulling the trigger until the magazine is empty, the hammer being partially cocked by the slide as it recoils from each shot. After a shot is fired, the trigger must be allowed to move forward until a click is heard. If the trigger is pulled before the trigger mechanism fully resets, the hammer may or may not fire the cartridge.
8. **Immediately following the firing of a shot, if a subsequent shot is not to be fired at once, remove the magazine and lock the slide back using the slide stop. Be sure the chamber is empty. If the slide is shut, the shooter should always assume that there is a cartridge in the chamber! Don't rely on your memory to know if a gun or magazine is loaded. With the pistol pointed in a safe direction, visually inspect the magazine and chamber.**


 <b>WARNING - FIRING</b>	
	<p>The slide automatically opens and shuts quickly while firing. Keep face and hands away from rear. Hot brass is ejected quickly and can burn you. Always wear shooting glasses and hearing protection.</p>
<b>SLIDE OPENS FAST - HOT BRASS EJECTED</b>	

 <b>WARNING - HANDLING</b>	
	<p>Do not load the pistol until you are ready to use it, and unload it immediately when you have completed shooting. (See “Unloading Warning” on page 18.)</p> <p>If dropped or struck, the pistol may fire. Keep chamber empty unless actually firing!</p> <p>For maximum safety when carrying the pistol with a loaded magazine in place, the chamber should be empty, the slide should be closed and safety engaged. If placed into a holster, check it to be sure that the slide is not retracted far enough to chamber a cartridge from the magazine.</p> <p>The user should never depend on any mechanical device to justify careless handling or permitting the pistol to point in an unsafe direction. The shooter should always be alert to the possibility of accidental discharge. <b>The only absolutely safe pistol is one in which the slide is open, the chamber is empty, and there is no magazine in the firearm.</b></p>
<b>ANY FIREARM MAY FIRE IF DROPPED</b>	

## TO LOAD AND FIRE (WITHOUT MAGAZINE)

In the event that the magazine is missing or for training purposes (where it is desirable that only one cartridge be loaded and fired at a time for safety), the pistol can be fired with the magazine removed. To do so, **keep the pistol pointed in a safe direction**, grasp the slide, and retract it fully to the rear. Next, push the slide stop upward to lock the slide to the rear. Insert a single cartridge directly and fully into the chamber. Taking care to keep the pistol pointed in a safe direction and your finger outside the trigger guard, retract slightly and release the slide. This will cause the slide to move vigorously forward into the firing position. **WARNING: The pistol is ready to fire once the slide moves forward.**

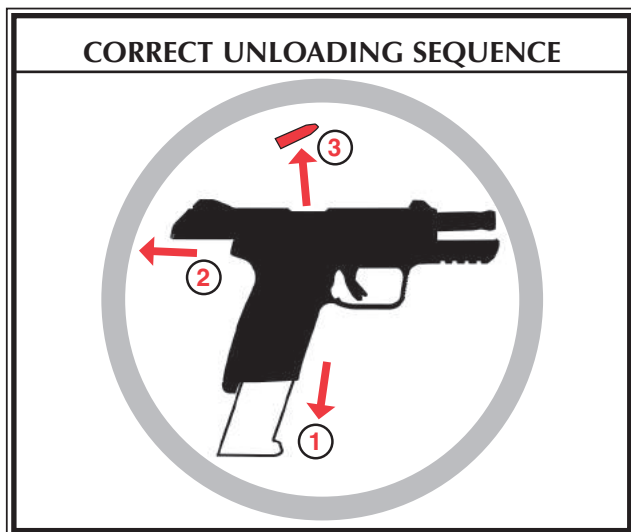


<b>! WARNING - UNLOADING</b>	
	<p>So that the pistol can be used as a single loader, it will fire whether or not a magazine is in the gun if a cartridge is chambered. <b>Removing the magazine does not unload pistol!</b> To unload, <b>first</b> remove magazine, <b>then</b> pull slide to rear, eject chambered cartridge, and <b>visually inspect chamber to be sure it is empty.</b> Always point the pistol in a safe direction when loading or unloading.</p>
<b>FIREARM WILL FIRE WITH MAGAZINE OUT</b>	

## TO UNLOAD

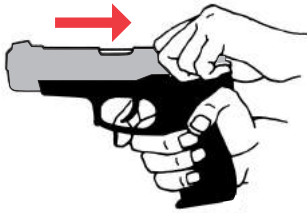
**WARNING:** This sequence must be followed exactly as outlined. Failure to do so can result in the chamber being unintentionally loaded with a live cartridge!

1. The muzzle of the pistol must be pointing in a safe direction at all times, and fingers should be outside of the trigger guard.
2. Remove the magazine from the frame by pressing the magazine latch. **REMEMBER** that even though the magazine has been removed, a live round remaining in the chamber can still be fired (see “Unloading Warning,” above).
3. Hold the pistol firmly and grasp the slide. Retract the slide to its rearmost position briskly to extract and eject any chambered cartridge. Always double check, visually and physically, the chamber, breech-face, and the interior of the frame are clear of any live rounds. When the slide is fully retracted, push upward on the slide stop, then allow the slide to move forward until it comes to rest with the rear projection of the slide stop resting in the notch on the lower left side of the slide.





## WARNING - SLIDE RETRACTION



The slide should always be pulled rearward (“retracted”) by pulling the rear portion of the slide. **Always keep fingers away from trigger!**



**Never put any part of your hands or body over the muzzle while retracting the slide** for loading, unloading, inspection, or clearing a malfunction.

**KEEP HANDS  
AWAY FROM MUZZLE AND  
FINGER OFF TRIGGER**

4. To close the slide, **again check to be sure the chamber and breech-face are empty.** Pull the slide to its rearmost position and release it. The slide will snap forward. Keep fingers out of ejection port on top of slide!
5. If the magazine contains cartridges, they can be removed by sliding each cartridge forward and out of magazine, one at a time, until the magazine is empty.
6. Push the empty (unloaded) magazine into the frame until the magazine latch locks it in place.

## TO EXTRACT AND EJECT A CHAMBERED CARTRIDGE

When the pistol is fired, the same gas pressure that drives the bullet forward also acts through the cartridge case to push the slide to the rear. The action causes extraction and ejection of the fired cartridge case. If the shooter wishes to eject a chambered cartridge manually, follow the procedure “To Unload,” p. 18. When the slide is operated by hand, there can be a failure to extract the cartridge from the chamber, or a failure to eject the cartridge clear of the pistol. These failures usually are the result of the slide not being pulled rearward vigorously. From the foregoing, it is clear that the gun user must:


1. **Always visually check the chamber and the breech-face after opening the slide to eject a chambered cartridge.** If the slide is not vigorously retracted when being operated by hand, the extracted cartridge can be “ejected” into the magazine well of the frame or remain held to the breech-face by the extractor.

2. Thoroughly clean the chamber and the extractor as often as necessary.

If an empty magazine is in the pistol when the slide is being hand retracted to extract a cartridge, the cartridge may drop on top of the magazine or remain held to the breech-face by the extractor. Then, when the slide goes forward, the cartridge will be chambered again! **Remember — always remove the magazine before clearing the chamber, and visually ensure that no cartridges remain in the firearm.**

## TO CLEAR A MALFUNCTION ("JAM" or "MISFIRE")

1. **Be certain the muzzle is continually pointed in a safe direction and keep fingers out of the trigger guard.**
2. If the misfire is the result of a cartridge not firing or unusual report (either louder or quieter than normal), keep the pistol pointed in a safe direction for 30 seconds prior to ejecting the chambered round or retracting the slide.
3. If possible, remove the magazine. It may be necessary to manually remove a jammed cartridge that has only been partially stripped from the magazine. If so, use extreme care. Lock the slide open with the slide stop before attempting to clear the jam. Drawing the slide fully to the rear may bring the jammed cartridge along. **Keep your face away from the ejection port during this operation.** When attempting to clear a jam, use only wood "tools" so that the cartridge will not be damaged or the primer ignited. A 3/16" wooden dowel with a point on one end is useful.
4. Visually check to make sure that all cartridges have been removed from the pistol. Safely dispose of any cartridges involved in a malfunction incident. **Do not use damaged ammunition in any firearm.**
5. Inspect the bore and chamber to ensure that they are not obstructed. **Failure to detect and correctly remove a bore obstruction can result in serious injury!**

<b>! WARNING - MALFUNCTIONS</b>	
	<p>Any autoloading pistol may occasionally malfunction. If a cartridge hangs up, jams, or binds when being chambered, do not attempt to force it into the chamber by pushing or striking the slide. Carefully remove it.</p> <p>Most failures of a cartridge to feed or to chamber properly are caused by a damaged magazine, incorrect firearm handling, insufficient lubrication, or improper ammunition.</p> <p>Whatever the cause, the user of the pistol must, above all, recognize that any cartridge jam can result in a potentially very dangerous situation of a cartridge discharging before it is properly chambered. If this happens, the cartridge case may rupture and its fragments fly out of the ejection port of the pistol with sufficient force to cause serious injury. <b>Always wear shooting glasses!</b></p>
<b>HITTING PRIMER CAN BURST CARTRIDGE</b>	

## TO MINIMIZE MALFUNCTIONS ("JAMS" or "MISFIRES")

1. If it appears that the jam was caused by the type of ammunition being used, try another brand, type, or lot number. Remember — use only factory ammunition of the correct caliber.
2. If changing ammunition does not at once eliminate malfunctions, then the following steps should be taken:
  - a. Thoroughly clean the pistol, paying particular attention to the removal of accumulated grease and dirt. Use a bristle brush and solvent to remove grease and fouling from the breech-face, extractor, chamber, and feed ramp area immediately behind the chamber.
  - b. Check to be sure that the magazine spring firmly returns the magazine follower to the top of the magazine.
  - c. Check the magazine lips to be certain that they are free of nicks and burrs and that they are not deformed or cracked.
  - d. Remove excess oil and solvent from all cleaned components, load the magazine, and try the pistol again. Make sure you are following the correct loading and firing sequence as described in this manual.
  - e. If none of the above steps is effective, try a different magazine of Ruger manufacture. If use of a new magazine does not resolve the issue, contact the Ruger Customer Service Department. (See "Shipping Firearms For Repair" on page 34.)
  - f. **Alterations to the pistol or use of non-Ruger magazines and accessories may cause malfunctions. See "Alteration Warning" on page 12.**

## DISASSEMBLY

**Be sure pistol is unloaded!**

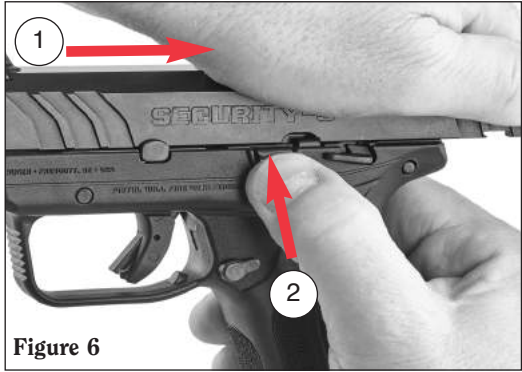
An on-line video demonstrating the disassembly and reassembly of the **SECURITY-9®** pistol can be viewed by going to **Ruger.com/TechTips**.

1. **Keep pistol pointed in a safe direction.** Press the magazine latch and withdraw the magazine from the frame (see Figure 5).

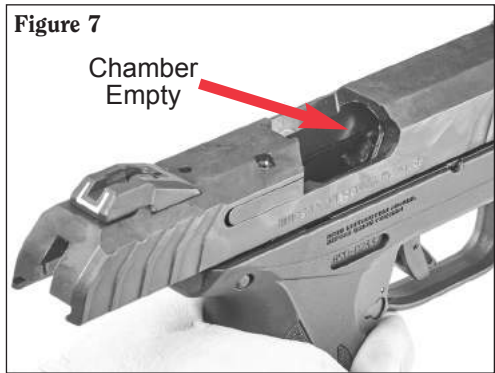


**Figure 5**

2. Pull the slide to the rear and lock it in the open position by pushing upward on the slide stop. (see Figure 6).



3. Inspect the chamber and verify that it is empty (see Figure 7).



4. Retract the slide slightly and release it (see Figure 8). This will disengage the slide stop and allow the slide to move fully forward.



5. Retract the slide approximately 1/16" so the front of the slide aligns with the front of the grip frame. Pry loose the takedown pin using a non-marring armorer's tool or other flat, blunt tool (see Figure 9).

**Be careful not to scratch the slide.**



6. Remove the takedown pin completely (see Figure 10).



7. Move the slide assembly forward and separate it from the grip frame (see Figure 11).



8. Compress the recoil spring assembly slightly to disengage it from its seat against the barrel lug, and remove it completely (see Figure 12).




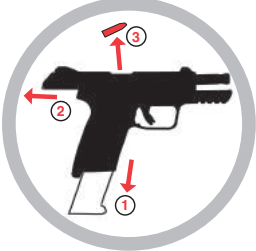
9. Remove the barrel. It will be necessary to move the barrel forward slightly and then down and back to extract it from the slide (see Figure 13).



10. The pistol is now disassembled for cleaning (see Figure 14).



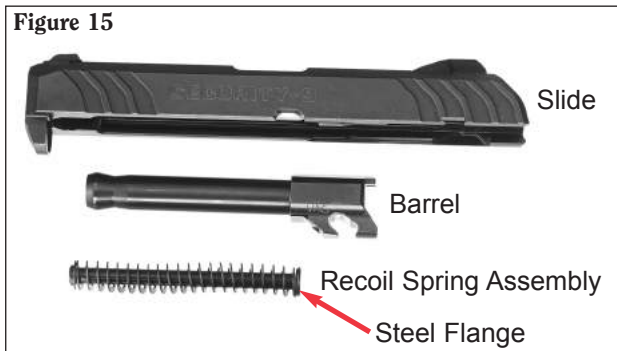
Figure 14

 <b>WARNING - DISASSEMBLY</b>	
	<p>Always unload a firearm before cleaning, lubrication, disassembly or assembly.</p>
<b>UNLOAD BEFORE DISASSEMBLY</b>	



## REASSEMBLY

1. Be certain chamber and magazine are empty.
2. With slide held upside down, replace barrel and push it rearward into its locked position.
3. Replace the recoil spring assembly into position. The rear end of the guide rod seats against the barrel lug. **NOTE:** When replacing the recoil spring assembly, be sure the steel flange on the recoil spring assembly is oriented toward the back of the pistol. (See Figure 15.)



4. Replace the slide onto the frame and place in its “closed” position, as if the pistol were fully assembled.

5. Retract the slide about 1/16” so the front of the slide aligns with the front of the grip frame. Place the pin side of the takedown pin in the recess between the slide and the grip frame. The flat on the bottom of the head of the takedown pin should be facing the bottom of the pistol (see Figure 16a). Push the takedown pin inwards until the head is flush with the side of the grip frame (see Figure 16b). It may be necessary to adjust the slide very slightly back and forth to align the takedown pin and fully seat it flush against the grip frame.



6. Replace empty magazine in the frame.

# CHECK YOUR PISTOL'S FUNCTION

Periodic inspection of any firearm is important to ensuring its safe operation. It is important to clean and inspect your firearm after each range session or whenever the firearm has been exposed to sand, dust, moisture, humidity, or other adverse conditions. Proper maintenance increases the longevity of your firearm and will allow early detection of worn or broken parts.

Prior to each use, visually inspect the firearm to ensure no components are damaged, missing, loose, bent, cracked, chipped, or peened. If you observe excessive wear, you should stop using your pistol and contact customer service or a trained certified gunsmith to evaluate its condition and replace any worn parts if necessary.

After any disassembly and reassembly, it is important to verify that the action is working correctly before any live firing is attempted.

## **FIRST, BE SURE THERE IS NO AMMUNITION IN THE CHAMBER OR THE MAGAZINE AND KEEP THE PISTOL POINTED IN A SAFE DIRECTION!**

- a. CHECK THE FUNCTION OF THE SLIDE: With the magazine out of the gun, the slide forward, and the manual safety in the "FIRE" position, pull the slide to the rear and release it. Perform this step twice.
  - The slide should move freely all the way to the rear and close completely under force of the recoil spring.
  - Insert an **EMPTY** magazine into the pistol and pull the slide to the rear. Release the slide. The slide should be held open by the slide stop.
  - Remove the magazine. The slide should remain open.
  - Pull the slide fully to the rear and release it. The slide should move freely forward to its closed position.
- b. CHECK THE FUNCTION OF THE TRIGGER: With the magazine removed from the pistol, cycle the slide open and closed to ensure the hammer is cocked. The end of the hammer is visible through the opening at the rear of the slide when cocked.
  - Move the manual safety to "SAFE" and attempt to pull the trigger. The trigger should move rearward slightly and stop. The hammer should not fall.
  - Move the manual safety to "FIRE" and pull the trigger. The hammer should fall.
  - Attempt to move the manual safety to "SAFE." The manual safety lever should ***NOT*** move to "SAFE" with the hammer in the fired position.
  - With the manual safety in the "FIRE" position, keep the pistol pointed in a safe direction, pull the trigger, and hold it to the rear. Keeping the trigger pulled to the rear, cycle the slide to reset the hammer. Slowly release the trigger. The trigger should move forward and you will hear/feel the trigger reset. The hammer should not fall.
  - Move the manual safety to the "SAFE" position and attempt to pull the trigger. The trigger should move rearwards and stop. The hammer should not fall.

**If any of the above function checks fail or if you are uncertain, please consult a competent gunsmith or contact Ruger Customer Service at 336-949-5200 for further firearm inspection before using the firearm.**

# FRONT SIGHT REMOVAL & INSTALLATION

**NOTE:** Follow these instructions for pistols equipped with the Ruger® factory plastic sights as shown. For other sight options follow the manufacturer's instructions or consult a gunsmith for replacement and adjustment.

**Tools Required:** punch (plastic or brass is preferred); a vice with padded jaws; and a non-marring hammer.

**NOTE:** The front sight can be removed from either side of the slide.

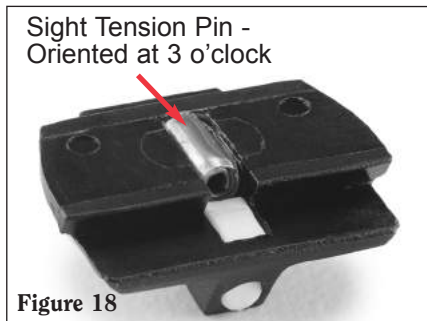
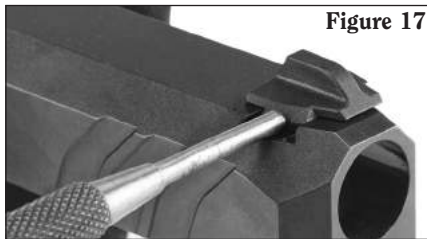
## Removing the Front Sight:

1. Follow the disassembly procedure starting on page 21. Clamp the slide in the vice with the front sight assessible.

**NOTE:** Excessive force is not needed to move the front sight in its dovetail. The sights are made of molded polymer and can be marred if struck too hard. Also, the finish on the slide can be marred if the punch should slip while removing or installing the front sight.

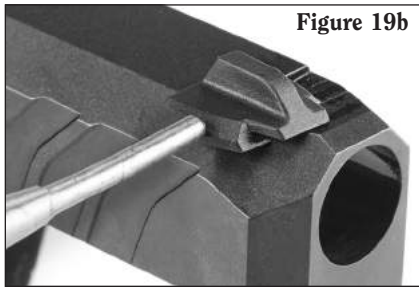
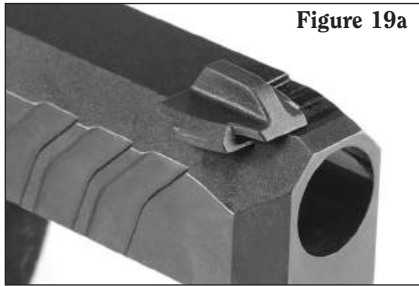
2. Place the punch against the wide base of the front sight and gently tap the punch to move the sight sideways and off the slide (see Figure 17).

**NOTE:** There is a sight tension pin in the cavity under the front sight. (See Figure 18.) Be careful not to lose the tension pin when the sight is separated from the slide.



### Installing the Front Sight:

1. The sight tension pin should be oriented in the cavity on the bottom of the sight with the seam of the pin at the 9 or 3 o'clock position (see Figure 18, p. 28). If the pin falls out of the cavity when the sight is held upright, it can be held in place with a dab of grease. Orient the front sight so the sighting surface is facing rearward.
2. Place the front sight into its dovetail in the slide and by hand push it inward until the bottom of the tension pin stops against the slide (see Figure 19a).
3. Using the hammer and punch, gently tap the front sight towards the center (see Figure 19b). It will automatically stop in the center and stay there when it is driven in far enough. **NOTE:** Like any dovetail sight, excessive removal and installation will cause the sight/slide fit to loosen.

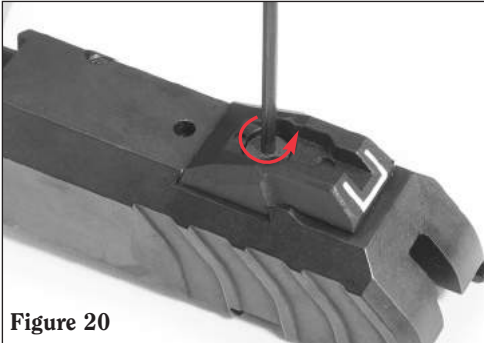


# REAR SIGHT REMOVAL & INSTALLATION

**NOTE:** Follow these instructions for pistols equipped with the Ruger® factory plastic sights as shown. For other sight options follow the manufacturer's instructions or consult a gunsmith for replacement and adjustment.

## Removing the Rear Sight:

Follow the disassembly procedure starting on page 21.



Lay the slide flat on a suitable working surface. With a 5/64" Allen wrench, remove the rear sight screw from the slide by turning it counter-clockwise (see Figure 20).

Figure 20

Using a non-marring hammer, tap the rear sight out of the dove tail (from either direction - see Figure 21).

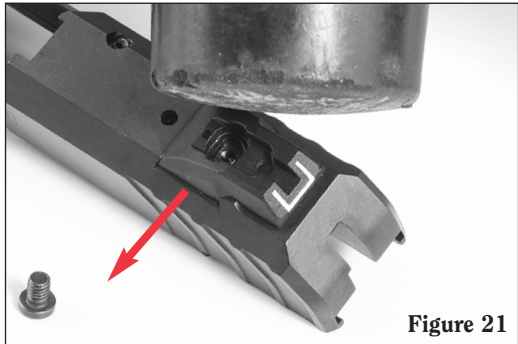


Figure 21

## Installing the Rear Sight:

Place the rear sight in the dove tail (from either side). With a non-marring hammer, gently tap the sight until it is centered in the slide.

Install the rear sight screw using a 5/64" Allen wrench (see Figure 22) and tighten.

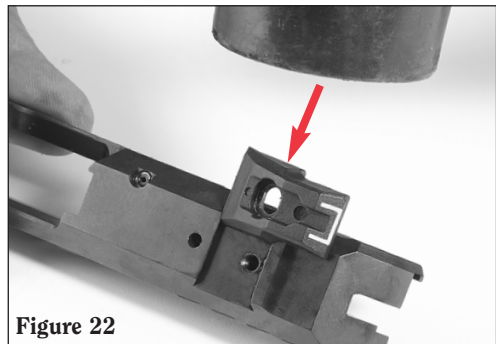


Figure 22

## REAR SIGHT ADJUSTMENT

The **SECURITY-9**<sup>®</sup> pistol is equipped with a rear sight which is adjustable for windage.

**To adjust for windage**, after the rear-sight lock screw has been loosened using a 5/64" Allen wrench, the rear sight can be drifted laterally in its dovetail on the top of the slide by tapping it with a wooden- or plastic-headed hammer or similar implement. Move the rear sight in the direction you want the shot to move on the target. After the rear sight is adjusted, tighten the rear-sight lock screw. The front sight has a white-dot insert, and the rear sight has a white outline for rapid target acquisition and easy alignment of the sights to obtain a correct sight picture.

## MAGAZINE INSPECTION AND CARE

### Make Sure Magazine Is Unloaded!

Check the magazine frequently. The magazine follower must move freely and have adequate tension so that each cartridge is quickly raised to the feeding position. The magazine lips should be clean and free of cracks, dents, or nicks, so that cartridges are held in their proper feeding position.

If the magazine becomes dirty, it should be disassembled and thoroughly cleaned. The following disassembly instructions apply:

**Snap-On Base** - Use a punch to press in on the magazine spring seat where it protrudes into the hole in the magazine floorplate. Slide the magazine floorplate toward the front of the magazine, **be careful to prevent the forcible ejection of the magazine spring seat and compressed magazine spring**. Withdraw the magazine spring seat and magazine spring and follower from the magazine body. Reassemble in reverse order.

When cleaning is necessary, use a solvent that will not rust the metal components or adversely affect the magazine body. After the magazine has been soaked to loosen foreign matter, be certain to shake it vigorously (with the loading opening away from you) to remove solvent or residue from within the magazine. **Penetrating oils and solvents inside a magazine can "kill" or weaken cartridge primers or powder which can result in failures to fire or other possibly dangerous malfunctions, such as leaving a bullet in the bore!**

After cleaning, always check to be certain that the magazine follower movement and tension are correct, and that no solvent or debris remain. **Improper reassembly of the magazine can cause failure to feed, which is a potentially dangerous malfunction. If cleaning does not restore proper tension, or if you experience a problem with the magazine, don't use it. Get a new one.** New magazines can be purchased at **ShopRuger.com**.

## CARE AND CLEANING

### Make Sure Firearm Is Unloaded!

**BEFORE CLEANING, BE CERTAIN THE PISTOL AND ITS MAGAZINE ARE UNLOADED.** (See “Warning – Unloading,” p. 18.)

At regular intervals, or whenever the pistol has been exposed to sand, dust, extreme humidity, condensation, immersion in water, or other adverse conditions, disassemble, clean, and oil it. Proper periodic maintenance is essential to the reliable functioning of any firearm.

An on-line video demonstrating the proper cleaning procedure of the **SECURITY-9®** pistol can be viewed by going to **Ruger.com/TechTips**.

To clean the pistol, proceed as follows:

1. Disassemble (fieldstrip) the pistol to the extent described on pages 21 - 25.
2. Using a cleaning rod, run a properly sized, solvent-wetted patch through the bore several times. Then attach a solvent-wetted bristle brush to a cleaning rod and run it back and forth the full length of the bore as many times as necessary to remove grease and dirt from the bore and chamber. Clean the bore with dry patches and examine. Bore fouling can contribute to reduced accuracy, and grease accumulation in the chamber can interfere with proper feeding of cartridges from the magazine.
3. Using powder solvent on a clean patch or bristle brush, remove powder residue from all components of the pistol. After cleaning, run a dry patch through the bore, then follow with a patch that is very lightly oiled. Wipe all surfaces clean with a cloth, then wipe all surfaces with a patch or cloth that has been very lightly oiled.
4. **NOTE:** Only a light application of oil is needed to provide adequate lubrication of moving parts and to prevent rust. Excess accumulation of oil tends to attract particles of dust and dirt and may congeal in cold weather, which can interfere with the safe and reliable functioning of the pistol.
5. Before firing, remove all oil and grease from the bore.

 <b>WARNING - LUBRICATION</b>	
	Firing a pistol with oil, grease, or any other material even partially obstructing the bore may result in damage to the pistol and serious injury to the shooter and those nearby. Do not spray or apply lubricants directly on ammunition. If the powder of a cartridge is affected by the lubricant, it may not be ignited, but the primer firing may push the bullet into the bore where it may be lodged. <b>Firing a subsequent bullet into the obstructed bore may damage the pistol and cause serious injury or death to the shooter and those nearby.</b> Use lubricants properly. You are responsible for the proper care and maintenance of your firearms.
	<b>IMPROPER LUBRICATION DESTROYS FIREARMS</b>



## STORAGE

**FIREARMS SHOULD NOT BE STORED LOADED!**

**USE THE LOCKING DEVICE SUPPLIED WITH THE PISTOL  
TO RENDER IT INOPERATIVE FOR SAFE STORAGE.**

**(SEE PAGE 10)**

*Do not* keep the pistol stored in a leather holster or case. Leather attracts moisture, even though the holster or case may appear to be perfectly dry.

 <b>WARNING – STORAGE</b>	
	<ul style="list-style-type: none"><li>• Never place or store any firearm in such a manner that it may be dislodged. Firearms should always be stored securely and unloaded, away from children and careless adults.</li><li>• Use the locking device supplied with the pistol for storage. The use of a locking device or safety lock is only one aspect of responsible firearms storage.</li><li>• For increased safety, firearms should be stored unloaded in a location that is both separate from their ammunition and inaccessible to children and any other unauthorized person.</li></ul>
<b>STORE SECURELY &amp; UNLOADED</b>	



## SERVICE AND PARTS POLICY

If you have any questions with regard to the performance of your **RUGER® SECURITY-9®** pistol please contact our Customer Service online at **Ruger.com** or call the Customer Service Dept. at 336-949-5200. Fully describe all circumstances and conditions involved. If you should return your pistol to the factory for repair, or order parts for it, please comply with the following suggestions for prompt service:



**WARNING—BEFORE SHIPPING ANY FIREARM, BE ABSOLUTELY CERTAIN THAT IT AND ITS MAGAZINE ARE UNLOADED. DO NOT SHIP CARTRIDGES WITH A FIREARM.**

### SHIPPING FIREARMS FOR REPAIR:



**NOTE:** You must obtain a Repair Authorization Number before returning your firearm. An authorization number can be obtained by contacting Customer Service online at **Ruger.com** or calling the Customer Service Department at 336-949-5200. Firearms should be sent prepaid. We will not accept collect shipments. Any **RUGER® SECURITY-9®** pistol returned to the factory for repair should be sent to: Sturm, Ruger & Company, Inc., Customer Service Department, 200 Ruger Road, Prescott, AZ 86301-6181.

The Federal Gun Control Act, as well as the laws of most states and localities, do not prohibit an individual (who is not otherwise barred from purchasing or possessing a firearm) from shipping a firearm directly to the manufacturer for repair. However, before you ship your firearm to us, be certain that your state or locality does not have a law or regulation which will prohibit you from receiving the firearm (or any included magazines) from us after it has been repaired. If such receipt is prohibited, please have a federally licensed firearms dealer ship the firearm to us. If your firearm is sent to us by a dealer, it will be returned to that dealer after being repaired. If a handgun (pistol or revolver) is shipped by an individual who does not hold a Federal Firearms License, it must be shipped for overnight delivery via U.P.S., Federal Express, or other, similar private overnight service. **NOTE:** Handguns may not be shipped via U.S. Mail. Persons who do not hold a Federal Firearms License are prohibited by Federal law from shipping a handgun by Mail. Handguns mailed in violation of the law may be impounded or confiscated by the Post Office and the non-FFL may be subject to prosecution.

Please do not include holsters, custom grip panels, or accessories with a firearm being shipped to the factory for service. **DO NOT SEND FIREARM BOXES OR LITERATURE THAT YOU CONSIDER TO BE COLLECTOR'S ITEMS – THESE ARE INVARIABLY DAMAGED OR DESTROYED IN SHIPMENT.** Always insure your shipment.

Enclose a letter which includes your name, address, telephone number, firearm serial number and model, and repair authorization number. Describe in detail the trouble you have experienced with your firearm, or the work you wish to have done. Merely stating that the firearm “needs repair” is inadequate information. Please enclose copies of any previous correspondence.

All work performed is subject to a minimum labor charge and charges for shipping and handling. Most models can be reblued, but custom gunsmithing service or nonstandard alterations are NOT AVAILABLE from Ruger Customer Service Departments. Please contact the Customer Service Department for pricing information. In states that have a magazine capacity limitation, **DO NOT RETURN** so-called “high capacity” magazines as Ruger may not be able to return the magazine to you.

 <b>WARNING – PARTS PURCHASERS</b>	
	<ul style="list-style-type: none"><li>• It is the purchaser’s responsibility to be absolutely certain that any parts ordered from the factory are correctly fitted and installed.</li><li>• Firearms are complicated mechanisms and <b>IMPROPER FITTING OF PARTS MAY RESULT IN A DANGEROUS MALFUNCTION, DAMAGE TO THE FIREARM, AND SERIOUS INJURY TO THE SHOOTER AND OTHER PERSONS.</b></li><li>• The purchaser and installer of parts must accept full responsibility for the correct adjustment and functioning of the firearm after such installation.</li></ul>
<b>PARTS MUST FIT CORRECTLY</b>	

## ORDERING PARTS

Please contact the Prescott, Arizona Customer Service Department for parts availability and current prices. All parts orders for the **RUGER® SECURITY-9®** pistols should be sent to: Sturm, Ruger & Company, Inc., Customer Service Department, 200 Ruger Road, Prescott AZ 86301-6181, 336-949-5200. We cannot comply with open account or C.O.D. requests. Payment in full via credit card (Visa, MasterCard, or Discover only), money order or certified bank check (no personal checks or cash, please) is required before any service will be performed. Please provide your credit card number, your name as it appears on the credit card, the expiration date and the 3-digit security code. All parts orders are subject to a minimum charge and charges for shipping and handling. Order parts by **Part Name and specify the model and entire serial number** of the firearm for which the parts are being ordered. There is a minimum labor charge plus a shipping and handling charge if the parts are factory fit. All factory fit parts are fit on an exchange basis only. We will not return the replaced parts. Please contact the Customer Service Department for pricing information.

Because it is a serial numbered component, the **RUGER® SECURITY-9®** pistol frame insert is defined as a “firearm” by Federal law and is not sold as a separate component.

\*Parts designated by an asterisk must be factory fit. These parts are fit on an exchange basis only. We will not return the replaced parts. We will not return any part that is broken, malfunctioning, badly worn or has been modified. See “Warning - Parts Purchasers,” above.



**WARNING: A firearm containing broken, malfunctioning or badly worn parts should not be fired!**

# RUGER® SECURITY-9® PISTOL

## PARTS LIST

Design, prices and specifications subject to change without notice.

**SPECIFY MODEL, CALIBER, AND SERIAL NO. WHEN ORDERING**

(See Exploded View on Page 37)

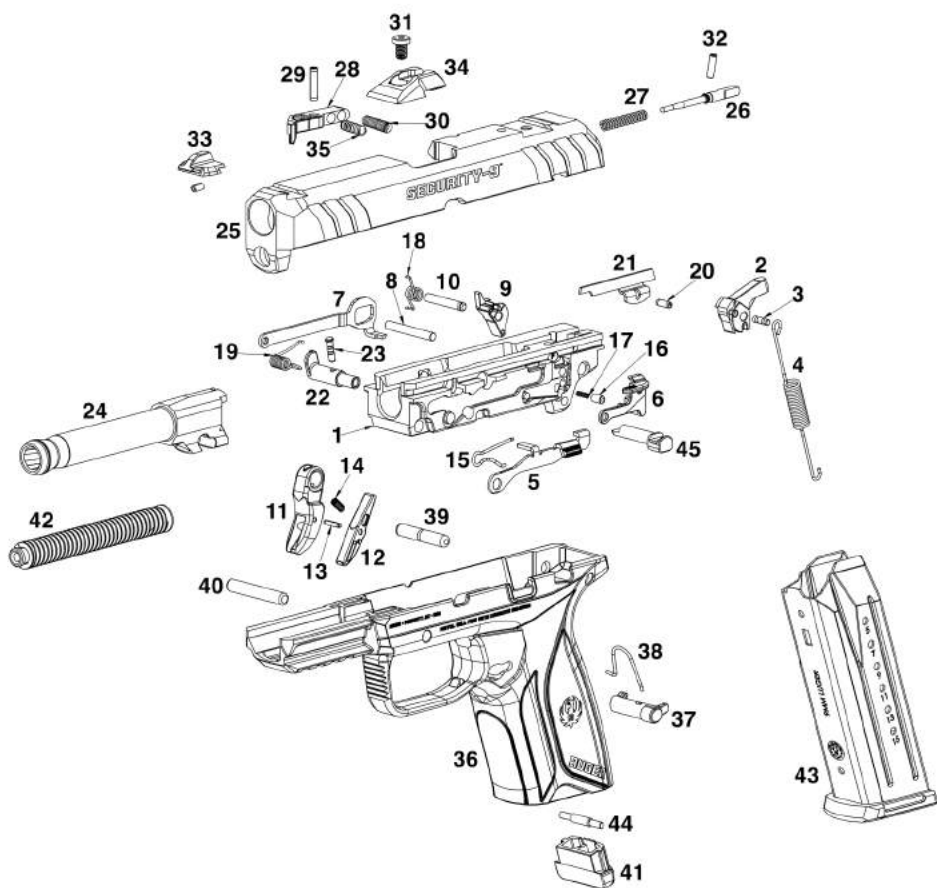
Key No.	Part Name	Key No.	Part Name	
†	1	Frame Insert	* 24	Barrel
*	2	Hammer	* 25	Slide
	3	Hammer/Spring Pin	26	Firing Pin
	4	Hammer Spring	27	Firing Pin Spring
	5	Slide Stop	28	Extractor
*	6	Manual Safety	29	Extractor Pivot Pin
*	7	Trigger Bar	30	Rear Extractor Spring
	8	Hammer Pivot Pin	31	Rear Sight Screw
*	9	Sear	32	Pin, Firing Pin
	10	Sear Pivot Pin	33	Front Sight
	11	Trigger, Outer		(Includes Tension Pin)
	12	Inner Trigger	34	Rear Sight
	13	Inner Trigger Pivot Pin	35	Forward Extractor Spring
	14	Inner Trigger Spring	* 36	Grip Frame
	15	Slide Stop Spring	37	Magazine Latch
	16	Safety Plunger	38	Magazine Latch Spring
	17	Manual Safety Detent Spring	39	Frame Insert Pin, Rear
	18	Sear Spring	40	Frame Insert Pin, Front
	19	Trigger Spring	41	Hammer Spring Cap
	20	Hammer Spring Retainer	42	Guide Rod
	21	Ejector	43	Magazine
	22	Trigger Pivot	44	Hammer Spring seat Pin
	23	Trigger Pivot Pin	45	Takedown Pin

† The Frame Insert is a serial-numbered component and is defined as a “firearm” by Federal Law and is not sold as a separate component.

\* PARTS SO MARKED MUST BE FACTORY FIT

# RUGER® SECURITY-9® PISTOL

## EXPLODED VIEW



## THE BASIC RULES OF SAFE FIREARMS HANDLING

We believe that Americans have a right to purchase and use firearms for lawful purposes. The private ownership of firearms in America is traditional, but that ownership imposes the responsibility on the gun owner to use his firearms in a way which will ensure his own safety and that of others. When firearms are used in a safe and responsible manner, they are a great source of pleasure and satisfaction, and represent a fundamental part of our personal liberty.

Firearms do not cause accidents! Firearms accidents are almost always found to have been the result of carelessness or ignorance on the part of the shooter of the basic rules of safe gun handling.

The following rules must be observed by gun users at all times. Safe gun handling is not just desirable, it is absolutely essential to your safety, the safety of others, and the continuation of gun ownership and sport shooting as we know it today.

### 1. LEARN THE MECHANICAL AND HANDLING CHARACTERISTICS OF THE FIREARM YOU ARE USING.



Not all firearms are the same. The method of carrying and handling firearms varies in accordance with the mechanical provisions for avoiding accidental discharge and the various proper procedures for loading and unloading. No person should handle any firearm without first having thoroughly familiarized himself with the particular type of firearms he is using, and with safe gun handling in general.

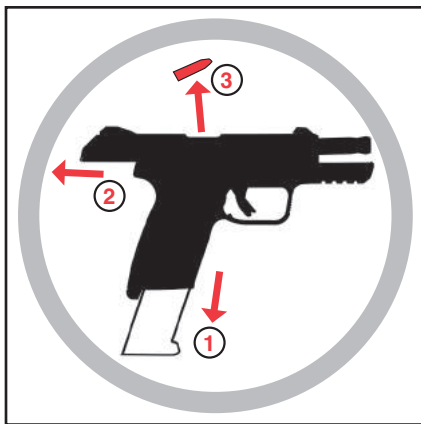
### 2. ALWAYS KEEP THE MUZZLE POINTED IN A SAFE DIRECTION.



Be sure of the bullet stop behind your target, even when dry-firing. Never let the muzzle of a firearm point at any part of your body or at another person. This is particularly important when loading or unloading a firearm. In the event of an accidental discharge, no injury can occur as long as the muzzle is pointing in safe direction. A safe direction means a direction that will not permit a discharged bullet to strike a person, or to strike an object from which the bullet may ricochet.

A safe direction must take into account the fact that a bullet may penetrate a wall, ceiling, floor, window, etc., and strike a person or damage property. Make it a habit to know exactly where the muzzle of your gun is pointing whenever you handle it, and be sure that you are always in control of the direction in which the muzzle is pointing, even if you fall or stumble. Keep your finger off the trigger until you are ready to shoot.

### 3. FIREARMS SHOULD BE UNLOADED WHEN NOT IN USE.



Firearms should be loaded only when you are in the field or on the target range or shooting area, ready to shoot. Firearms and ammunition should be securely locked in safes, racks or cabinets, or by using the locking device supplied with the firearm when not in use. Ammunition should be safely stored separate from firearms. Store your firearms out of sight of visitors and children. It is the gun owner's responsibility to be certain that children and persons unfamiliar with firearms cannot gain access to firearms, ammunition, or components.

### 4. BE SURE THE BARREL IS CLEAR OF OBSTRUCTIONS BEFORE SHOOTING.

Even a bit of mud, snow or excess lubricating oil or grease in the bore may cause the barrel to bulge, or even burst on firing, and can cause injury to the shooter and bystanders. Be sure that you are using ammunition of the proper caliber and loading for the gun you are using. If the report or recoil on firing seems weak, or doesn't seem quite right, **CEASE FIRING IMMEDIATELY**, unload your firearm, and check to be sure that no obstruction has become lodged in the barrel. Never try to shoot an obstruction out!





### **5. BE SURE OF YOUR TARGET BEFORE YOU SHOOT.**

Don't shoot unless you know exactly where your bullet is going to strike. Be sure of the bullet stop behind your target, even when dry-firing with an unloaded gun. If you are in the field hunting, do not fire at a movement or noise. Take the time to be absolutely certain of your target before you pull the trigger.

### **6. WEAR SHOOTING GLASSES AND HEARING PROTECTION WHEN YOU SHOOT.**

All shooters should wear protective shooting glasses and adequate hearing protection when shooting. Exposure to shooting noise can damage hearing, and wearing adequate eye protection when shooting is essential.



### **7. NEVER CLIMB A TREE OR FENCE WITH A LOADED FIREARM.**

Put the firearm down carefully before climbing a fence, and unload it before climbing or descending a tree or jumping over a ditch or other obstruction. Never pull or push a loaded firearm toward yourself or another person. When in doubt, or whenever you are about to do anything awkward, unload your gun!

## 8. DON'T SHOOT AT A HARD SURFACE OR AT WATER.

Bullets can glance off many surfaces like rocks or the surface of water and travel in unpredictable directions with considerable velocity.



## 9. NEVER TRANSPORT A LOADED FIREARM.

Firearms should always be unloaded before being moved or placed in a vehicle. A suitable carrying case or scabbard should be used to carry an unloaded firearm to and from the shooting area.

## 10. AVOID ALCOHOLIC BEVERAGES WHEN SHOOTING.

Don't drink until the day's shooting is over. Handling firearms while under the influence of alcohol in any form, or medications that could affect your judgement or coordination, constitutes a criminal disregard for the safety of others.





## A BRIEF ACCOUNT OF AN EXTRAORDINARY ACHIEVEMENT: RUGER® FIREARMS

Sturm, Ruger & Company, Inc., had its beginning in a small machine shop occupying a rented frame building in Southport, Connecticut. In January, 1949, with an initial investment of only \$50,000 and an idea, William B. Ruger and Alexander M. Sturm started production of a .22 caliber autoloading pistol—a design which was so successful that it became the cornerstone upon which one of the most comprehensive lines of sporting firearms ever made in America was established. After Alex Sturm's death in 1951, William B. Ruger continued to direct the Company until his death in 2002. William B. Ruger, Jr. continued to provide guidance, which helped make this Company a sound and successful enterprise, until his retirement in 2006. The Company has continued to prosper, under new management and guidance from our Board, with new products and fresh perspectives.

Ruger, in this relatively short time, has established itself as a leading small arms design organization, developing a unique and broad line of fine quality sporting, military and police firearms to become one of the world's most famous producers of revolvers, pistols, rifles and shotguns. Since 1949, Ruger craftsmen have built many millions of firearms.

During its five decades of growth and progress under the leadership of William B. Ruger, the Company developed a business philosophy and implemented policies which represent a constructive influence in the life of modern America. From the beginning, Ruger played a positive role in conservation efforts and has supported the interests of shooters through such groups as the National Rifle Association, National Shooting Sports Foundation, and many regional sportsmen's organizations.

The Company has always endeavored to market its firearms for constructive and recreational purposes, to emphasize the traditional and responsible aspects of shooting, to render meaningful public services, and to encourage shooters in constructive, responsible, and safe participation in the shooting sports. Its motto, "Arms Makers For Responsible Citizens®," exemplifies this Company philosophy.

Today, Ruger® is particularly mindful of those elements which have contributed to the creation of its success, and extends heartfelt thanks to its many loyal employees and customers.

Instruction manuals for all Ruger® firearms,  
can be downloaded from our website at:

**Ruger.com**

## NOTES

## WHY NO WARRANTY CARD HAS BEEN PACKED WITH THIS NEW RUGER® FIREARM

The Magnuson-Moss Act (Public Law 93-637) does not require any seller or manufacturer of a consumer product to give a written warranty. It does provide that if a written warranty is given, it must be designated as "limited" or as "full" and sets minimum standards for a "full" warranty. Sturm, Ruger & Company, Inc. has elected not to provide any written warranty, either "limited" or "full", rather than to attempt to comply with the provisions of the Magnuson-Moss Act and the regulations issued thereunder. There are certain implied warranties under state law with respect to sales of consumer goods. As the extent and interpretation of these implied warranties varies from state to state, you should refer to your state statutes. Sturm, Ruger & Company wishes to assure its customers of its continued interest in providing service to owners of Ruger® firearms.



**STURM, RUGER & COMPANY, INC.**  
**200 Ruger Road**  
**Prescott, Arizona 86301 U.S.A.**  
**Ruger.com**

**Arms Makers For Responsible Citizens®**

**A COPY OF THE INSTRUCTION MANUAL FOR ANY RUGER®  
FIREARM IS AVAILABLE FROM THE FACTORY FREE ON REQUEST, OR IT MAY BE  
DOWNLOADED FROM OUR WEBSITE AT RUGER.COM.  
THESE INSTRUCTION MANUALS CONTAIN IMPORTANT  
WARNINGS WHICH MUST BE UNDERSTOOD  
BEFORE USING THESE FIREARMS.**

**The Following are Sturm, Ruger & Co., Inc. Trademarks:** "All-Weather," "Bisley," "Gold Label," "I'm a Ruger American," "LC6," "LCR-357," "LC380CA," "Mark II," "Mark III," "Mark IV," "MAX-9," "Model 96," "P345," "P345D," "P345PR," "P85," "P89," "P90," "P91," "P93," "P94," "P95," "P97," "PC Carbine," "R.I.O.S.," "Ruger-5.7," "Ruger Marksman Adjustable," "Ruger 77/50," "Ruger 10/17," "Security-Six," "Service-Six," "77/357," "Single-Seven," "Speed-Six," "SR45," "SR-556C," "SR-556VT," "Super Bearcat," "Target Grey," "10/22-FS," "This is Ruger. This is America," "Tri-Flex," "22 Charger," "22/45," "22/45 RP," and "Your Next Handgun."

**The Following are Registered U.S. Trademarks Belonging to Sturm, Ruger & Co., Inc.:** "AC-556," "AR-556," "Arms Makers For Responsible Citizens," "Bearcat," "Blackhawk," "BX-15," "BX-25," "BX-Trigger," Eagle - solid logo design, Eagle Hard "R" logo holding gun, Eagle 'R' - soft 'R' & hard 'R' logo design, Eagle w/SR, Eagle w/soft 'R' linear logo design, Eagle w/hard 'R' linear logo design, Eagle w/soft 'R' stacked logo design, Eagle w/hard 'R' stacked logo design, Eagle w/soft 'R' linear logo design & "Rugged, Reliable Firearms" below logo, Eagle w/hard 'R' linear logo design & "Rugged, Reliable Firearms" below logo, "EC9s," "Elite 452," "GP100," "Hawkeye," "It's Mine and It's American," "It's Mine. And It's American," "LC380," "LC9," "LC9s," "LC9s Pro," "LCP," "LCR," "LCRx," "M77," "Match Champion," "Mini-14," "Mini Thirty," "9E," "Old Army," "Power Bedding," "Redhawk," "RUGER," "Ruger American," "Ruger American Pistol," "Ruger American Pistol" flag design, "Ruger American Rifle," "Ruger American Rimfire," "Ruger Custom Shop," "Ruger Hunting" - phrase & logo design, "Ruger Precision," "Ruger Precision Rifle" - phrase & logo design, "Ruger 77/17," "Ruger 77/22," "Ruger 77/44," "Ruger SP101," "Ruger 10/22 Takedown" phrase & logo design, "Ruger Titanium," "Ruger 22/45 Lite," "Ruger Vaquero," "Rugged, Reliable Firearms," "Security-9," "Silent-SR," "Single-Nine," "Single-Six," "Single-Ten," the "SR" Design, "SR9," "SR9c," "SR40," "SR40c," "SR-22," "SR22," "SR-556," "SR-556 Takedown," "SR-762," "SR1911," "Super Redhawk Alaskan," "10/22," & "Wrangler."