

Remington

# OWNER'S MANUAL

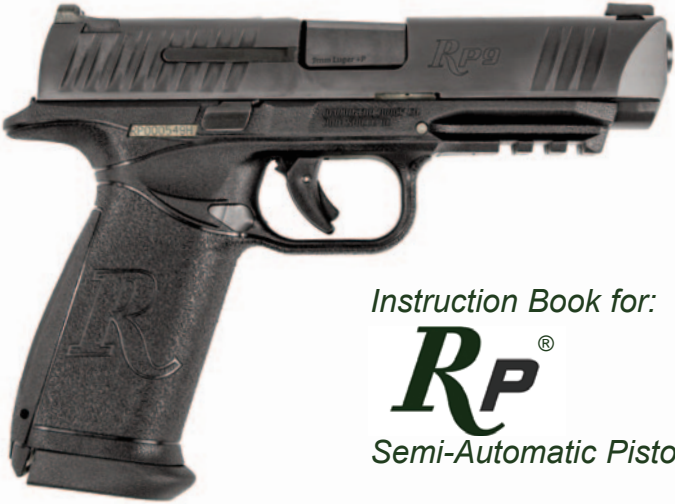

Instruction Book for:

**RP**<sup>®</sup>

Semi-Automatic Pistol

This manual contains operating, care, and maintenance instructions. To assure safe operation, any user of this firearm must read and understand this manual before using the firearm. Failure to follow the instructions and heed the warnings in this manual can cause property damage, personal injury, and/or death. This manual should always accompany this firearm, and be transferred with it upon change of ownership.

**WARNING!** Keep this firearm out of the reach of children, unauthorized individuals, and others unfamiliar with the safe handling of firearms.



## Alert Symbols and Definitions:

**WARNING!**

Indicates a hazardous situation which, if not avoided, will result in property damage, personal injury or death.

**CAUTION!**

Indicates a hazardous situation which, if not avoided, could result in minor to moderate personal injury.

**NOTE:**

Address practices not related to personal injury.

## Congratulations on Your Choice of a Remington Pistol.

Remington would like to thank you for purchasing our product. With proper care, it should give you many years of dependable use and enjoyment. For best results, we recommend that you use Remington or Barnes Ammunition; the ammunition used in factory testing your firearm against our rigorous function and performance standards.

Page 2	..... Safety is Critical to Performance
Page 3	..... The Ten Commandments of Firearm Safety
Page 9	..... Safe Firearm Handling
Page 9	..... Dangerous Procedures
Page 10	..... General Operation
Page 11	..... The Serial Number and Caliber Identification
Page 11	..... Important Parts of the Firearm
Page 11	..... The Trigger Safety
Page 12	..... The Locking Device
Page 12	..... The Magazine Release
Page 13	..... Clearing/Unloading the Firearm
Page 14	..... Checking Barrel for Obstructions
Page 14	..... Removing Obstructions from the Barrel
Page 15	..... Loading the Firearm
Page 17	..... Discharging the Firearm
Page 18	..... Cleaning, Lubrication, and Maintenance
Page 19	..... Disassembling the Firearm for Cleaning
Page 22	..... Cleaning/Reassembling the Magazine
Page 22	..... Cleaning the Barrel
Page 23	..... Cleaning the Recoil Spring/Guide Rod Assembly
Page 23	..... Cleaning the Frame Assembly
Page 23	..... Reassembling the Firearm
Page 25	..... Function Testing the Firearm
Page 28	..... Firearm Maintenance Record
Page 29	..... RP Autoloading Pistol; Exploded View
Page 30	..... RP Autoloading Pistol; Parts List
Page 31	..... How to Obtain Parts and Service
Page 33	..... Firearm Owner's Record
Page 34	..... Firearm Maintenance Record
Page 35	..... Notes

## Safety is Critical to Performance.

A superbly crafted firearm is only as good as the hands that hold it. You can never be too careful. Shooting accidents are often caused by careless oversights such as failing to control the direction of the muzzle, failing to fully engage the safety, leaving ammunition in the chamber, or using improper loads. These oversights can result in the destruction of life, limb, or property. There is no calling back a bullet once it has been fired, so it is critical that you know the principles of safe firearm handling and storage before you ever take your new firearm out of the box.

The proper use and performance of your firearm depends on correct assembly and maintenance, so it is critical that you familiarize yourself with the information in this manual. Even if you are a veteran shooter with a collection of firearms, take the time to read this manual. Not all firearms are the same. That means the first step in safe handling is to learn and become familiar with the features and requirements of your new firearm.

### THE TEN COMMANDMENTS OF FIREARM SAFETY

The Ten Commandments of Firearm Safety should be etched in your memory forever. Let them govern your action wherever and whenever you are involved with firearms in the field, on the range, or in your home. Please take the time to review and understand these rules.



#### 1st C O M M A N D M E N T

ALWAYS KEEP THE MUZZLE POINTED IN A SAFE DIRECTION.

*This is the most important firearm safety rule.* A safe direction is one in which an accidental discharge will not cause injury to yourself or others. Never allow your firearm to point at anything you do not intend to shoot. Be especially careful when you are loading or unloading. Treat every firearm as if it were loaded. And make it a habit to know where the muzzle is pointed at all times, even when your firearm is unloaded. No one will be injured by an accidental discharge if you keep your firearm pointed in a safe direction. It is that simple.



#### 2nd C O M M A N D M E N T

FIREARMS SHOULD BE UNLOADED WHEN NOT IN USE.

*Load your firearm only when you are in the field or on the target range and ready to fire.* Never let a loaded firearm out of your sight or out of your hands. Unload it as soon as you are finished shooting - before you bring it into your car, camp or home. Remember, unloading your firearm means unloading it completely, so there is no ammunition in the chamber or in the magazine. Before handling a firearm or passing it to someone else, visually check the chamber, receiver and magazine to

be certain they do not contain ammunition. Always keep the firearm's action open when not in use. Never assume a firearm is unloaded even if you were the last person to use it. Always check for yourself.

- Let common sense rule when you carry a loaded firearm. If you are in a situation that could risk accidental discharge - such as crossing a fence, wading through a stream or climbing a tree - always unload your firearm. Never pull or push a loaded firearm toward yourself or another person. Never carry a loaded firearm in a scabbard, detached holster or gun case.

- Certain firearms are equipped with internal security devices to prevent unauthorized use. Some firearm owners use external devices, such as cable locks and trigger blocks, for the same purpose. Even if you use such a device, you should still keep your firearm unloaded when stored or not in use. Using internal or external devices cannot substitute securing your firearm and ammunition in separate, locked locations.

- Safe storage of firearms is just as critical as safe handling. Never store firearms loaded. Be sure to keep your firearm in a secure place where unauthorized persons cannot get their hands on them without your knowledge.

- Take special care if there are children around. Children are fascinated by firearms. It is a natural curiosity that can have tragic consequences when not properly supervised. Store your firearm in a locked gun safe or some other location that physically bars a child from gaining access.

- Ammunition should be stored and locked in a location separate from your firearm. Never leave an unsecured firearm or ammunition in a closet, dresser drawer or under the bed. Remember, it is your responsibility to make sure that children and others unfamiliar with firearms cannot get access to your firearm and ammunition.



*Firearms should be stored in a secure place where children cannot access them. A gun safe is an ideal way to secure your firearm*



## 3rd C O M M A N D M E N T

### DO NOT RELY ON YOUR FIREARM'S SAFETY.

*Treat every Firearm as if it can fire at any time, whether or not there is pressure on the trigger.* Your firearm has been carefully designed to maximize performance and safety. However, because a firearm's safety is a mechanical device, it could fail.

Human error is a more likely reason for a firearm safety to fail. By mistake, you may think the safety is on when it really is not. Or the safety may have been disengaged without your knowledge. Or you could think your firearm is unloaded when there is actually a cartridge or shell in it. A mechanical safety is not a substitute for common sense. It is merely a supplement to your proper handling of a firearm.

Never touch the trigger on a firearm until you are ready to shoot. Keep your fingers away from the trigger when you are loading or unloading. And do not pull the trigger when the safety is engaged or positioned between safe and fire.

Before using your firearm, read this instruction book to understand the exact location and operation of your firearm's safety. Even when the safety is on, maintain control

of your loaded firearm and control the direction of the muzzle. In other words, do not rely on your safety to justify careless handling. If your firearm's internal mechanisms are broken or have been altered, your firearm may fire even when the safety is on. Remember, you and your safe firearm handling practices are your firearm's best *safety*.

## 4th C O M M A N D M E N T

### BE SURE OF YOUR TARGET AND WHAT IS BEYOND IT.

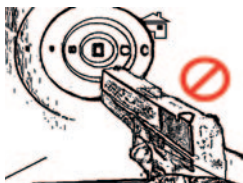

*You can not stop a shot in mid-air, so never fire unless you know exactly where your shot is going and what it will strike.* Never fire at a sound, a movement or a patch of color. A hunter in camouflage can easily be mistaken for a target by an impulsive shooter. Before you pull the trigger, be absolutely sure of your target and what is behind it. Make sure the shot has a backstop such as a hillside or dense

material like sand. Remember, bullets can travel great distances with tremendous velocity. Know how far your shot will go if you miss your target or the bullet ricochets.

## 5th C O M M A N D M E N T

### USE PROPER AMMUNITION.

*Every firearm is designed to use a certain caliber or gauge of ammunition.* Using the wrong ammunition, mixing ammunition or using improperly reloaded ammunition can cause serious personal injury or death. And it only takes one cartridge or shotshell of the incorrect caliber or gauge, or which has been improperly reloaded, to destroy your firearm.

It is your responsibility to make sure the ammunition you use exactly matches the caliber or gauge of your firearm. Refer to this instruction book to find out the specific requirements of your firearm. Always read and heed the instructions on ammunition boxes.

Confusing shells or cartridges can cause serious personal injury or death and destroy your firearm. Examine your shells or cartridges closely and use only the precise caliber or gauge for your specific firearm. For example, suppose you accidentally loaded a 20 ga. shell into a 12 ga. shotgun. Because the 20 ga. shell is too small for the chamber, the 20 ga. shell could travel down the barrel and get lodged in the bore. If you then loaded a standard 12 ga. shell behind it and fired, the 12 ga. shot will slam into the lodged 20 ga. shell and may cause the barrel to explode right in your hand. This is commonly called a 12/20 burst, and it can kill you. Check all ammunition before you load it to make sure it matches your firearm's requirements. Typically every firearm cartridge and shell is head-stamped with its caliber or gauge for easy identification. Likewise, you will find the caliber or gauge of your new Remington firearm imprinted on the barrel.

### **Reloading Requires Extra Diligence**

If you reload ammunition, then you are responsible for ensuring that the components you use and the performance of your loads meets SAAMI guidelines for safety and per-

formance – the same guidelines your firearm was tested to at the factory. Never use ammunition which has been reloaded by someone else. Reloading requires a thorough knowledge of reloading procedures and a deep respect for the explosive potential of gunpowder. Reloading incorrectly, whether by deviating from load specifications established by powder or component manufacturer's recommendations or exceeding 'maximum loads' could result in severe injury to yourself or bystanders or severe damage to your firearm. Dangerously high pressure can result from an overcharge of powder or other deviations from established reloading guidelines creating the potential for severe damage to your firearm and possible personal injury and/or death to you and/or bystanders. If you chose to reload, be extremely careful.



## 6th C O M M A N D M E N T

**IF YOUR FIREARM FAILS TO FIRE WHEN THE TRIGGER IS PULLED, HANDLE WITH CARE.**

*If for some reason the ammunition does not fire when you pull the trigger, stop and remember the 1st Commandment of Firearm Safety - always keep the muzzle pointed in a safe direction. After waiting a minimum of one minute, keep your face away from the breech, put the safety on, carefully open the action, unload the firearm, and dispose of the cartridge safely. Remember that any time there is a shell in the chamber your firearm is loaded and ready to use. Even if you tried to shoot and your firearm did not fire, treat your firearm as if it could still discharge.*



## 7th C O M M A N D M E N T

**ALWAYS WEAR EYE AND EAR PROTECTION WHEN SHOOTING.**

*Your sight and hearing risk injury from shooting and should be protected at all times. Wear protective shooting glasses to guard against falling shot, clay target chips, powder residue, ruptured cartridge cases and even twigs and branches in the field. Also be sure to wear eye protection when you are disassembling or cleaning a firearm so that tensioned parts (like springs) and cleaning solvents do not come in contact with your eyes. Continued exposure to shooting noise can permanently damage your hearing. On the range, where shooting volume is the loudest, be sure to use the maximum protection of a headset. Learn to use ear protection at all times.*



## 8th C O M M A N D M E N T

**BE SURE THE BARREL IS CLEAR OF OBSTRUCTIONS BEFORE SHOOTING.**

*Before loading your firearm, open the action and make sure there is no ammunition in the chamber or magazine. Check the barrel for any obstructions or debris. Even a small amount of snow, mud, excess lubricant or grease in the bore can dangerously increase pressure and cause the barrel to bulge or burst when firing. Use a cleaning rod and patch to wipe away anti-rust compounds or any other residues or obstructions in the barrel. Never try to shoot out an obstruction by*

loading another shell and firing!

When firing, rely on your instincts. If the noise or recoil of your firearm seems weak, stop everything, unload your firearm and be sure nothing is lodged in the barrel. Remember the 12/20 burst? That is what can happen when the barrel is obstructed. Always be sure you are using the correct ammunition in your firearm and that it is free of obstructions.



## 9th C O M M A N D M E N T

**DO NOT ALTER OR MODIFY YOUR FIREARM AND HAVE IT SERVICED REGULARLY.**

*Your firearm has been designed to operate according to certain factory specifications. You will jeopardize your safety and that of others around you by attempting to alter its trigger, mechanical safety or other mechanisms. So never alter or modify your firearm in any way.*

Like any mechanical device, a firearm is subject to wear. It must be maintained and periodically serviced to assure optimum safety and performance. Only a qualified service facility should service, repair or modify your firearm. Consult your instruction book for instructions on how to send your firearm to the factory or for the location of the nearest Remington authorized repair station. Proper cleaning and lubrication are also important to firearm maintenance and are necessary to assure accuracy, safety and reliability. Before cleaning, always make sure that your firearm is completely unloaded. And always clean the barrel from the chamber end to the muzzle when possible.



Make it a practice to clean your bore every time you are going to shoot. Be sure to clean your entire firearm before and after long-term storage and no less than once a year. It is also important to clean your firearm whenever it has been exposed to adverse conditions such as rain, dirt, mud, snow, sleet or saltwater.

For safe and dependable operation of your firearm, all parts of your firearm must be properly cleaned and lubricated. Periodically inspect the internal workings of your firearm to be sure they are clean and free of rust, unwanted dirt and debris.

Use recommended lubricants on your firearm and do not over-lubricate. Excessive use of a non-recommended lubricant could adversely affect the function and safe operation of your firearm. Remember, you are responsible for the proper care and maintenance of your firearm. Failure to properly maintain your firearm cannot only damage or ruin your firearm, it can expose you and others to unnecessary risks of personal injury or death.

Remington has a wide range of firearm care products and resources for best results when cleaning your firearm; everything from solvents and lubricants to rods and patches. They are all available from your Remington dealer.



# 10th C O M M A N D M E N T

## LEARN THE MECHANICS AND HANDLING CHARACTERISTICS OF YOUR FIREARM.

*Not all firearms are alike.* They have different mechanical characteristics that dictate how you should carry and handle them. Anyone who plans to use a firearm should first become totally familiar with the type of firearm it is and the safe handling procedures for loading, unloading, carrying, shooting and storing it.

Before you even unpack your new firearm, read this instruction book from cover to cover and familiarize yourself with the different component parts of the firearm. Then read, understand and follow *The Ten Commandments of Firearm Safety* in this manual.

**WARNING!** Discharging firearms in poorly ventilated areas, cleaning firearms or handling ammunition may result in exposure to lead, a substance known to cause birth defects, reproductive harm, cancer and other serious physical injury. Have adequate ventilation at all times. Wash hands thoroughly after exposure.

### **SHOOT SOBER!**

There is one other rule that must be followed when handling firearms. In fact, respect for this rule is necessary in order to effectively practice *The Ten Commandments of Firearm Safety*. The rule is: SHOOT SOBER! Firearms and alcohol or drugs make a deadly combination. Never consume anything that would mildly impair your judgment or physical coordination when you are using a firearm. A staggering percentage of the shooting accidents that occur every year involve alcohol or drugs. Be smart. Always shoot sober and stay alive.

**WARNING!** Failure to follow any of these safety rules may cause personal injury or death to the shooter or bystander and damage to property. Do not use a firearm until you fully understand and practice *The Ten Commandments of Firearm Safety*. If you have any questions about the safe use of a Remington firearm, write to us at Remington, Consumer Service, P.O. Box 1911, Madison, NC 27025-0700, or call us at 1-800-243-9700.

### **DON'T KEEP THIS TO YOURSELF.**

Now that you are a firearm owner you have the obligation to help ensure that shooting sports are safe for everyone, participants and bystanders alike. You can do that by practicing these principles of firearm safety and passing them on to others - especially new shooters. Set an example for beginners. Be a guide to their safe entry into the exciting world of shooting sports. Invest your time and patience for the love of the sport and for its future. After all, it is your love of the sport that led you to buy a new firearm.

Firearm ownership is a right and privilege. It is a privilege, which carries with it a personal responsibility to use your firearm in a way which will ensure your safety and the safety of others. The preservation of this right and privilege depends on the personal commitment of you and your fellow shooters to the safe and responsible use of firearms. Let *The Ten Commandments of Firearm Safety* outlined in the book guide you at all times. Teach and promote these rules whenever you can. Remember, firearm safety depends on you! That is the only way to really enjoy your new firearm and to preserve sport shooting as we know it today.



## ALWAYS PRACTICE SAFE FIREARMS HANDLING

**WARNING!** It is very important that you read and understand this manual before using the new firearm. Each of the warnings should be read and heeded carefully. Always follow *The Ten Commandments of Firearm Safety* listed in this manual. Failure to follow these rules, warnings, and instructions, can result in property damage, personal injury, and/or death.

**WARNING!** If this firearm is carelessly or improperly handled, unintentional discharge can result in property damage, personal injury, and/or death.

**WARNING!** Use only clean, dry, high quality commercially manufactured ammunition in good condition which is appropriate to the caliber of your firearm. Remington recommends against the use of remanufactured ammunition, and urges extreme caution with reloaded ammunition. The use of improperly loaded or reloaded ammunition may cause property damage, personal injury, and/or death.

## DANGEROUS PROCEDURES

**WARNING!** This firearm may inadvertently chamber a cartridge if it is dropped or jarred with a loaded magazine in place. An unintentional discharge of a firearm may cause property damage, personal injury, and/or death.

**WARNING!** An unfired cartridge can discharge if left in a hot barrel, this is often referred to as a “cook-off”. Always keep the firearm pointed in a safe direction. If an unfired cartridge cannot be cleared from a hot barrel quickly, remove the magazine from the firearm and allow the barrel and unfired cartridge to cool 15 minutes. A cook-off can cause property damage, personal injury, and/or death.

**WARNING!** Never discharge a firearm with water or an obstruction in the barrel. Discharging the firearm with water in the barrel can cause property damage, personal injury, and/or death.

**WARNING!** If you experience a change in sound report and/or recoil while discharging the firearm, do not attempt to discharge the firearm again. A change in sound report and/or recoil can be symptoms of a defective cartridge, which could lead to an obstructed bore. Discharging a firearm with an obstructed bore can cause property damage, personal injury, and/or death.

## THANK YOU FOR BUYING A REMINGTON PRODUCT

Congratulations on your choice of the Remington RP firearm. With proper care, it should give you many years of dependable use and enjoyment. For best results, we recommend that you use Remington or Barnes® Ammunition - the ammunition used to test your RP against our rigorous function and performance standards.

## GENERAL OPERATION

The Model RP series handguns are tilt barrel, locked breech, striker fired, autoloading pistols. The RP handguns are capable of firing successive shots with each pull of the trigger. Once the last cartridge in the magazine is discharged and ejected, the slide will remain in the open position.



**FIGURE 1** This picture shows the main parts of a MODEL RP Series Pistol. The figure will aid in understanding the instructions.

**NOTE:** Some illustrations in this manual may depict cosmetic differences not related to performance or safety.

# IMPORTANT PARTS OF THE FIREARM

## THE SERIAL NUMBER AND CALIBER IDENTIFICATION

The serial number is located on the shooter's right side of the Frame, below the slide. See Figure 2.

The RP's caliber and cartridge designation is located on the Barrel. The marking is visible through the ejection port when the slide is fully forward. See Figure 3.

**WARNING!** Only use ammunition designated on the Barrel. Using ammunition not designated on the Barrel (improper caliber), including "Plus-P-Plus" (+P+) of the same caliber, may cause property damage, personal injury and/or death.



Figure 2

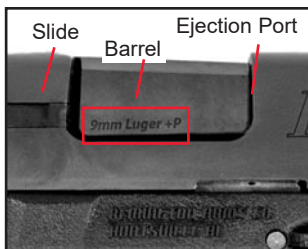

Figure 3

## THE TRIGGER SAFETY

The Trigger Safety of the Model RP handgun provides protection against accidental or unintentional discharge under normal usage when properly engaged and in good working order. This safety mechanism is not a substitute for following the rules of safe firearm handling. The Trigger Safety is located on the trigger. The Trigger can only be fully pulled when the Trigger Safety is fully depressed. See Figure 4.



Figure 4

## ADDITIONAL FEATURES

The Trigger Safety is the Model RP's manual safety mechanism. Additionally, the RP incorporates passive features providing additional protection against accidental or unintentional discharge during normal usage when in good working order. These passive features, such as the disconnecter, inertial striker system, striker safety, and trigger guard all work without direct input from the user as long as your firearm is kept clean and in good working order.

**WARNING!** Do not alter, bypass, or render the safety features of this firearm inoperative. Altering, bypassing, or rendering these features inoperative may cause property damage, personal injury, and/or death.

## THE LOCKING DEVICE

This firearm was originally sold with a key-operated locking device to assist the owner in protecting against unauthorized use. For proper installation of the locking device, see separate instructions provided with the locking device. These are storage locking devices. Keep your locking device engaged when your firearm is not in use. See Figure 5. Store the pistol unloaded and locked in a safe place. Store the ammunition and key separately from the pistol.



Figure 5

**WARNING!** The locking device does not eliminate the need for safe firearm handling and storage, including keeping this and every firearm unloaded and locked in a secure place when not in use. Read and follow these and other safety rules in this instruction book. See *The Ten Commandments of Firearm Safety* section of this manual. Failure to read, understand, and obey these instructions may cause property damage, personal injury, and/or death.

## THE MAGAZINE RELEASE BUTTON

The Magazine Release Button is used to release the magazine from the firearm. The Magazine Release Button is located on the left side of the pistol behind the trigger. To release a magazine from the pistol, depress the Magazine Release Button. See Figure 6.

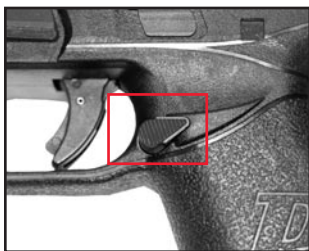

Figure 6

## THE TRIGGER ASSEMBLY

***Pulling the trigger DISCHARGES the firearm.***

The Trigger Assembly of the Model RP series of handguns has been designed for optimal trigger pull. The Trigger Assembly is not adjustable. All repairs to the Trigger Assembly must be made by the factory or a Remington Authorized Repair Center.

**WARNING!** Never place your finger on the trigger unless you are ready to discharge or FIRE the firearm. An unintentional or uncontrolled discharge of your firearm may cause property damage, personal injury, and/or death.

**WARNING!** Never manipulate, adjust or change any of the internal components of your firearm unless specifically directed to do so in this instruction manual. Improper manipulation of any internal component may affect the safety and reliability of your firearm and may cause property damage, personal injury, and/or death.

## CLEARING / UNLOADING THE FIREARM

**WARNING!** Never assume your firearm is unloaded. Always control the direction of the muzzle of your firearm, even if you think it is completely unloaded. Careless handling of a firearm may cause property damage, personal injury, and/or death.

**WARNING!** The firearm can be discharged with the magazine removed. If a cartridge is chambered, and the Slide is closed, pulling or depressing the Trigger will cause the firearm to discharge. An unintentional or uncontrolled discharge of your firearm may cause property damage, personal injury, and/or death.

**WARNING!** Always wear eye and hearing protection when handling a loaded firearm. Failure to do so could result in personal injury. See *The Ten Commandments of Firearm Safety* section of this manual.

1. Always keep the firearm pointed in a safe direction. See *The Ten Commandments of Firearm Safety* section of this manual.
2. Remove the magazine by pressing the Magazine Release Button. See Figure 6.
3. Firmly hold the firearm with your shooting hand, while keeping the Trigger clear of contact with fingers and/or other objects.
4. Pull and hold the Slide fully rearward with your support hand. If a cartridge was in the chamber, it should be ejected at this time. See Figure 7.
5. With the Slide fully rearward, lock the Slide in the open position by pushing the Slide Stop up, fully engaging the slide stop notch. See Figure 8.
6. Look into the ejection port and visually check the chamber and magazine well for cartridges, making sure the handgun is completely unloaded.
7. If the firearm is not unloaded, See the "Clearing / Unloading the Firearm" section of this manual.
8. Check the Breech Face, ensuring the Firing Pin is not protruding. See Figure 10.



Figure 7



Figure 8

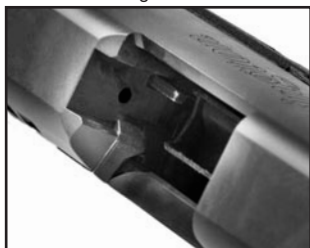

Figure 9

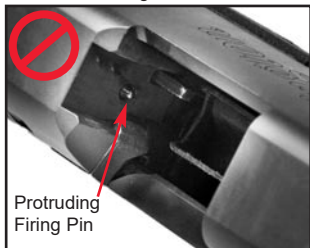

Figure 10

Figure 9. If the Firing Pin is protruding from the Breech Face, as in Figure 10, do not attempt to load or discharge the firearm. Have the firearm inspected by a Remington Authorized Repair Center before use.

**WARNING!** If the firing pin is protruding from the breech face, do NOT attempt to load or discharge the firearm. Have the firearm serviced by a Remington Authorized Repair Center. See the “How to Obtain Parts and Service from Remington” section in this manual. Loading a firearm with a protruding firing pin may cause an unintentional discharge resulting in personal injury and/or death.

9. Hold the magazine separate and apart from the pistol.
10. Place your thumb on the top cartridge and slide it forward and out of the magazine. See Figure 11.
11. Repeat step 10 until the magazine is completely empty.



Figure 11

## CHECKING THE BARREL FOR OBSTRUCTIONS

**WARNING!** NEVER try to clear or remove a barrel obstruction by loading another cartridge and firing it into the obstruction. This may cause property damage, personal injury, and/or death.

1. Always keep the firearm pointed in a safe direction. See *The Ten Commandments of Firearm Safety* section of this manual.
2. Remove the magazine by pressing the Magazine Release Button. See Figure 6.
3. Firmly hold the firearm with your shooting hand, while keeping the Trigger clear of contact with fingers and/or other objects.
4. Pull and hold the Slide fully rearward with your support hand. If a cartridge was in the chamber, it should be ejected at this time. See Figure 7.
5. With the Slide fully rearward, lock the Slide in the open position by pushing the Slide Stop up, fully engaging the slide stop notch. See Figure 8.
6. Look into the ejection port and visually check the chamber and magazine well to make sure the handgun is completely unloaded.
7. If the firearm is not unloaded, See the “Clearing / Unloading the Firearm” section of this manual.
8. Only after the firearm is unloaded, insert an appropriately sized cleaning rod into the muzzle.
9. Push the rod completely through the Barrel until the rod can be seen at the ejection port.

### Removing an Object from Inside the Barrel:

10. Insert the cleaning rod into the muzzle and lightly tap the rod to free

object from the Barrel.

11. Push rod all the way through the Barrel until the rod can be seen at the chamber opening.
12. If an object cannot be easily pushed out of the Barrel with a cleaning rod, return the firearm to the factory or a Remington Authorized Repair Center.

**WARNING!** Before loading the firearm, make sure the inside of the Barrel is free of dirt, oil, or other obstructions. Discharging the firearm with a dirty and/or obstructed Barrel may cause property damage, personal injury, and/or death.

## LOADING THE FIREARM

**WARNING!** Never assume a firearm is unloaded. Never carelessly handle a firearm. Always control the direction of the muzzle of a firearm, even if you think it is completely unloaded. Careless handling of any firearm can lead to property damage, personal injury, and/or death.

## AMMUNITION

**WARNING!** Only use ammunition designated on the Barrel. Using ammunition not designated on the Barrel (improper caliber), including "Plus-P" (+P) or "Plus-P-Plus" (+P+) of the same caliber may cause property damage, personal injury, and/or death.

**WARNING!** Ammunition contains chemicals known to the State of California to cause cancer and birth defects or other reproductive harm.

**WARNING!** Do not apply oil, grease or any lubricants to cartridges. Applying lubricants to cartridges may interfere with proper operation of the cartridge, resulting in property damage, personal injury, and/or death.

There are many different types of handgun ammunition available for your new Remington pistol. Remington designs firearms to function with most commercially available ammunition. Using different combinations of bullet weights, bullet types, and propellant types will result in a variation of bullet velocities, accuracy, and felt recoil, even in pistols of the same model. Your Remington handgun was designed and tested to use only ammunition of the caliber for which it is chambered.

Remington recommends that only ammunition be used in your new pistol that meets the standards set forth by the Sporting Arms and Ammunition Manufacturers' Institute, SAAMI.

Remington highly recommends the usage of Remington or Barnes branded ammunition products. Remington does not cover warranty problems when using reloaded or remanufactured ammunition. For addi-



tional warranty information, refer to page 32 or visit <http://www.remington.com/support/firearm-warranty-information>. Remington recommends consumers practice with their preferred brand of ammunition in their new pistol to ensure functionality and performance.

## LOADING THE CHAMBER AND MAGAZINE

**WARNING!** Safe Firearms Handling dictates that live ammunition should only be loaded into your firearm when you are ready to discharge the firearm. See *The Ten Commandments of Firearm Safety* section of this manual. Loading live ammunition into your firearm when you do not wish to discharge it could result in property damage, personal injury, and/or death.

**NOTE:** The bore should be cleaned before loading the firearm the first time. Follow cleaning instructions shown in the “Cleaning the Barrel” section of this manual.

1. Always keep the firearm pointed in a safe direction.
2. Verify the firearm is completely unloaded. See the “Clearing/Unloading the Firearm” section of this manual.
3. Firmly hold the firearm with your shooting hand, while keeping the Trigger clear of contact with fingers and/or other objects.
4. Pull and hold the Slide fully rearward with your support hand. If a cartridge was in the chamber, it should be ejected at this time. See Figure 7.
5. With the Slide fully rearward, lock the Slide in the open position by pushing the Slide Stop up, fully engaging the slide stop notch. See Figure 8.

### Loading the Magazine:

**WARNING!** Always check the cartridge for the correct caliber designation before loading the firearm. Use of an incorrect caliber cartridge could result in property damage, personal injury, and/or death.

**WARNING!** The use of improperly loaded ammunition can lead to barrel obstructions, excessive pressure, and/or inadvertent discharge of a firearm; these could each result in property damage, personal injury, and/or death. Use only quality factory ammunition loaded to SAAMI guidelines suitable for your firearm. Examine each cartridge, particularly around the primer. Look for dents, scratches, and other signs of damage. Do not use damaged ammunition! Use of damaged ammunition could result in property damage, personal injury, and/or death.

6. Push the correct number of cartridges of the correct type and caliber, one at a time, into the magazine, sliding the cartridge under the magazine feed lips until the cartridge head is against the rear wall of the magazine. See Figure 12.

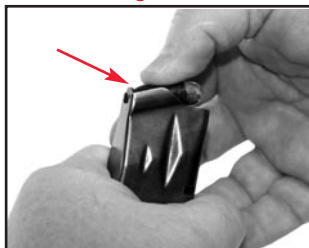

Figure 12



7. Keeping the bullet end of the cartridge aligned toward the chamber, push the full magazine into the magazine well of the firearm until the magazine latch is fully engaged.
8. Ensure the magazine is fully latched by pulling downward on the magazine. It should remain in the fully engaged position.

**WARNING!** Do not use excessive upward force when inserting a loaded magazine into the magazine well. Excessive upward force could cause an open slide to move forward, chambering a cartridge. An unintentional or uncontrolled discharge of your firearm may cause property damage, personal injury, and/or death.

### Loading the Chamber:

9. Firmly hold the firearm with your shooting hand, while keeping the Trigger clear of contact with fingers and/or other objects.
10. Pull and hold the slide fully rearward with your support hand. See Figure 13.

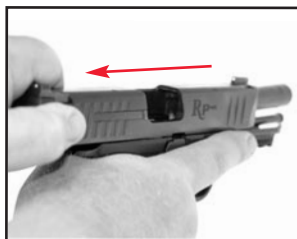

Figure 13

**CAUTION!** Before releasing the slide make sure fingers, hands, and clothing are clear of the slide as it moves forward. Failure to keep your fingers, hands, and clothing clear of the Slide's forward movement can cause property damage and/or personal injury.

11. Once the slide is in the full rear position and the muzzle pointed in a safe direction, release the slide, letting the slide move freely forward.

**WARNING!** The firearm is now fully loaded. Pulling or depressing the Trigger will discharge the firearm. An unintentional discharge of a firearm may cause property damage, personal injury, and/or death.

## DISCHARGING THE FIREARM

**WARNING!** Always wear eye and hearing protection when discharging any firearm. Failure to do so could result in personal injury. See *The Ten Commandments of Firearm Safety* section of this manual.

**WARNING!** The inside of the Barrel must be clean and free of any obstructions. Discharging the firearm with a dirty and/or obstructed Barrel may cause property damage, personal injury, and/or death. See *The Ten Commandments of Firearm Safety* section of this manual. If there is an obstruction, see the "Removing an Object from Inside the Barrel" section of this manual.

**WARNING!** Keep your body, face, and hands clear of the Slide's reciprocating movement and the ejection port. Failure to keep your body, face, and hands clear of the Slide's reciprocating movement and the ejection port can lead to property damage, personal injury, and/or death.

1. Always keep the firearm pointed in a safe direction.

2. To ensure proper control due to recoil while firing, grip the handgun firmly with both shooting hand and support hand. See Figure 14.
3. Point the muzzle at the intended target and pull the trigger. The firearm will discharge each time the trigger is pulled until the magazine and chamber are empty.
4. After the last cartridge is discharged, the slide stop will engage the slide, holding it in the open position.
5. Look into the ejection port and visually check the chamber and magazine well to make sure the handgun is completely unloaded.
6. Ensure the firing pin is not protruding from the breech face. See “Clearing/Unloading the Firearm” section of this manual.



Figure 14

**WARNING!** If a cartridge does not discharge when the trigger is pulled (misfire), keep the firearm pointed in a safe direction and wait one (1) minute before opening the action. See the “Clearing/Unloading Your Firearm” section of this manual. Failure to wait could result in a delayed and/or uncontrolled discharge of the cartridge, possibly causing property damage, personal injury, and/or death.

**WARNING!** If the “report” of a discharged cartridge is noticeably softer or louder or in any way irregular, stop shooting. Keep the firearm pointed in a safe direction, and carefully unload the firearm. Check the bore for obstructions. See “Checking the Barrel for Obstructions” section of this manual. Discharging a firearm with an obstruction can cause property damage, personal injury, and/or death.

**WARNING!** If the recoil of the firearm is harder or softer or any way irregular, stop shooting. Keep the firearm pointed in a safe direction; unload the firearm. Check the bore for obstructions. See the “Checking for and Removing a Barrel Obstruction” section of this manual. Discharging a firearm with an obstruction can cause property damage, personal injury, and/or death.

## CLEANING, LUBRICATION, AND MAINTENANCE

**WARNING!** Before cleaning or disassembling your firearm, make sure it is completely unloaded (both the chamber and the magazine). See the “Clearing/Unloading Your Firearm” section of this manual. Cleaning, lubricating, and performing maintenance on a loaded firearm may cause property damage, personal injury, and/or death.

**WARNING!** After each use, follow the lubrication and maintenance directions in this Owner’s Manual. If the firearm is immersed in water, it must be thoroughly dried, cleaned, and lubricated as soon as possible. In case of saltwater immersion, first flush all parts with fresh water, then dry, clean, and lubricate the firearm. If the firearm does not function properly, have it checked and corrected by a Remington Authorized Repair

Center before further use. Failure to follow these instructions may lead to firearm malfunctions which could result in property damage, serious personal injuries, and/or death.

## LUBRICATION

**WARNING!** The use of non-recommended lubricants or cleaners could adversely affect the function and safe operation of your firearm. Do not use congealing lubricants. The use of non-congealing lubricants such as Rem® Oil is strongly recommended. The use of improper lubricants may interfere with the safe operation of your firearm, resulting in property damage, personal injury, and/or death.

For safe and dependable operation of your handgun, the barrel and action must be periodically cleaned and lubricated. When a firearm is to be stored, it should be thoroughly cleaned and oiled. Outside metal surfaces should be wiped occasionally with Rem Oil. When the firearm is to be reused, all excess lubrication must be removed.

## DISASSEMBLING THE FIREARM FOR CLEANING

**WARNING!** Before cleaning or disassembling your firearm, make sure it is completely unloaded (both the chamber and the magazine). See the "Clearing/Unloading Your Firearm" section of this manual. Always wear eye protection when handling, disassembling and reassembling the firearm. Failure to follow these instructions may cause property damage, personal injury, and/or death.

**CAUTION!** Use extreme care when removing the Recoil Spring, as it is under compression. Wear eye protection to avoid personal injury. Failure to follow these instructions may cause property damage and/or personal injury.

**CAUTION!** The Model RP series of handguns should not be disassembled beyond what is described in this manual, except by the factory or a Remington Authorized Repair Center.

### Removing and Disassembling the Slide:

1. Always keep the firearm pointed in a safe direction.
2. Verify the firearm is completely unloaded. See the "Clearing/Unloading the Firearm" section of this manual.
3. Pull the Slide fully rearward and lock the Slide in the open position by pushing the Slide Stop up, fully engaging the slide stop notch. See Figure 8.
4. Push down on the rear of the Take Down Lever rotating it 90 degrees. See Figure 15.
5. Release the Slide Stop and allow the slide to move forward slowly. See Figure 16.
6. With the pistol completely empty and while keeping the firearm pointed in a



Figure 15

safe direction, hold the slide and pull the trigger. See Figure 17.



Figure 16



Figure 17



Figure 18

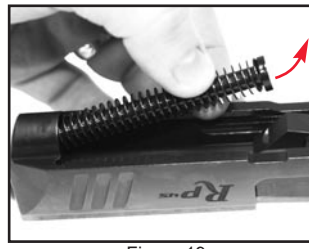

Figure 19

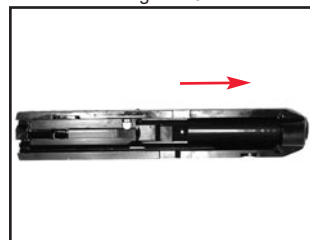

Figure 20

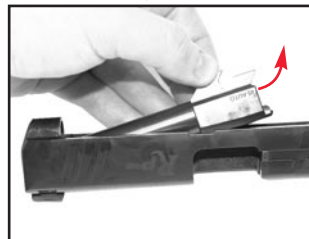

Figure 21

7. While keeping the trigger pulled, remove the Slide from the Frame Assembly by firmly pulling the Slide forward. See Figure 18.
8. Lift the rear of the Recoil Spring Guide Rod away from the Barrel. Remove the Recoil Spring/Guide Rod Assembly. See Figure 19.
9. Lift the Barrel slightly and slide forwards. See Figure 20.
10. Lift the Barrel away from the slide and slide rearwards. Remove the Barrel from the Slide. See Figure 21.

**NOTE:** Remington does not recommend disassembly beyond this point.

### Disassembling the Magazine:

**WARNING!** Unload the magazine before cleaning and/or servicing. See the "Clearing/Unloading Your Firearm" section of this manual. Always wear eye protection when handling, disassembling and reassembling the magazine. Cleaning and/or servicing a firearm and/or its components while it is loaded may cause property damage, personal injury, and/or death.

**CAUTION!** Use extreme care when removing the Magazine Spring, as it is under compression. Keep the bottom of the magazine body pointed away from you and in a safe direction during all steps of the magazine disassembly process. Wear eye protection to avoid personal injury. Failure to follow these instructions may cause property damage and/or personal injury.

1. Always keep the firearm pointed in a safe direction.
2. Remove the magazine by pressing the Magazine Release Button.
3. Verify the Magazine is completely unloaded. See the "Clearing/Unloading the Firearm" section of this manual.
4. Using a rigid tool, push on the Magazine Floor Plate Retainer through the access hole in the Magazine Floor Plate while partially sliding the Magazine Floor Plate toward the front of the Magazine body. See Figures 22 and 23.
5. Place a finger over the Magazine Floor Plate Retainer to prevent the parts from being expelled outward.
6. Remove the rigid tool and carefully finish sliding the Magazine Floor Plate off of the Magazine Body. See Figure 24.
7. Slowly allow the Magazine Spring to expand outward until all spring load is relieved.
8. Remove the Magazine Floor Plate Retainer, Magazine Spring, and Magazine Follower from the bottom of the Magazine Body. See Figure 25.

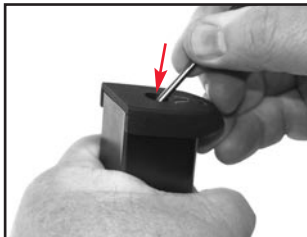

Figure 22

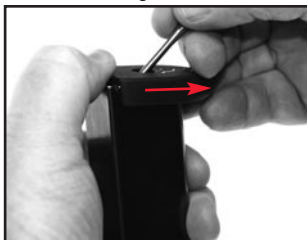

Figure 23



Figure 24

## Cleaning / Reassembling the Magazine:

**WARNING!** Unload the firearm before cleaning and/or servicing. See the "Clearing/Unloading Your Firearm" section of this manual. Always wear eye protection when handling, disassembling and reassembling the firearm. Cleaning and/or servicing a firearm and/or its components while it is loaded may cause property damage, personal injury, and/or death.

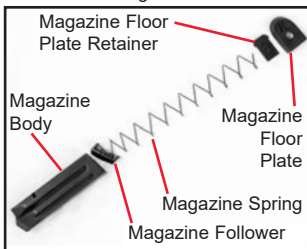

Figure 25

**CAUTION!** Keep the bottom of the Magazine Body pointed away from you and in a safe direction during all steps of the magazine disassembly process. Failure to follow these instructions may cause property damage and/or personal injury.

1. Disassemble the magazine following the instructions in the “Disassembling the Magazine” section of this manual.
2. Spray all magazine components with Rem Action Cleaner.
3. If necessary, use a brush to remove any fouling residue.
4. Wipe the magazine components with a clean patch. Allow to air dry.
5. Apply a light coating of Rem Oil to Magazine Body, Magazine Spring, and Magazine Follower.
6. Insert the Magazine Follower, Magazine Spring, and Magazine Floor Plate Retainer into the bottom of the Magazine Body. See Figure 25 for proper spring orientation.
7. Push on the Magazine Floor Plate, compressing the Magazine Spring and Magazine Floor Plate below the bottom of the Magazine Body.
8. Slide the Magazine Floor Plate onto the bottom of the Magazine Body. Ensure the Magazine Floor Plate Retainer tab snaps into the hole on the Magazine Floor Plate.

## CLEANING THE BARREL

**WARNING!** Unload the firearm before cleaning and/or servicing. See the “Clearing/Unloading Your Firearm” section of this manual. Always wear eye protection when handling, disassembling and reassembling the firearm. Failure to follow these instructions may cause property damage, personal injury, and/or death.

1. Always keep the firearm pointed in a safe direction.
2. Verify the firearm is completely unloaded.  
See the “Clearing/Unloading the Firearm” section of this manual.

**NOTE:** Follow the instructions and use the equipment provided in a quality cleaning kit such as a Remington Cleaning Kit. For recommendations, see your dealer or a Remington Authorized Repair Center.

3. Remove the Barrel from the pistol. See the “Removing and Disassembling the Slide” section of this manual.
4. Attach a patch to a cleaning rod tip and saturate with a cleaning solvent product such as Remington BriteBore® cleaning solvent.
5. Pass the patch through the bore starting from the chamber end to the muzzle several times to remove loose residue and fouling.
6. Select the correct caliber bore brush and attach the brush to the cleaning rod.
7. Spray the bore brush with Remington BriteBore cleaning solvent.
8. Push the cleaning rod through the complete length of the Barrel several times.
9. Remove the brush from the rod and attach a tip with a clean patch.
10. Push the cleaning patch through the bore.

11. Repeat several times using a new cleaning patch each time until the removed patch is free from fouling residue.
12. Push a clean patch saturated with Rem Oil through the Barrel.
13. Push a clean, dry patch through the Barrel to remove excess lubricant.
14. Brush the barrel feed ramp and outside surfaces to remove all fouling residue.
15. Wipe the Barrel with a clean patch and allow to air dry.
16. Apply a light coating of Rem Oil to the outside of the Barrel with a soft clean cloth.

**WARNING!** After cleaning, make sure the Barrel is free of obstructions, see the “Checking the Barrel for Obstructions” section of this manual. Discharging the firearm with a dirty and/or obstructed barrel may cause property damage, personal injury, and/or death.

## CLEANING THE RECOIL SPRING/GUIDE ROD ASSEMBLY

**WARNING!** Unload the firearm before cleaning and/or servicing. See the “Clearing/Unloading Your Firearm” section of this manual. Always wear eye protection when handling, disassembling and reassembling the firearm. Failure to follow these instructions may cause property damage, personal injury, and/or death.

1. Disassemble the firearm following the instructions in the “Disassembling the Firearm for Cleaning” section of this manual.
2. Spray the Recoil Spring/Guide Rod Assembly with Rem Action Cleaner.
3. Use a brush to remove any fouling residue, if necessary.
4. Wipe the Recoil Spring/Guide Rod Assembly with a clean patch and allow to air dry.
5. Apply a light application of Rem Oil to the Recoil Spring/Guide Rod Assembly with a soft clean cloth.

**NOTE:** To ensure the Model RP series of handguns performs to design specifications it is recommended the Recoil Spring be changed after every 5000 rounds of use.

## CLEANING THE SLIDE ASSEMBLY

**WARNING!** Unload the firearm before cleaning and/or servicing. See the “Clearing/Unloading Your Firearm” section of this manual. Always wear eye protection when handling, disassembling and reassembling the firearm. Failure to follow these instructions may cause property damage, personal injury, and/or death.

1. Disassemble the firearm following the instructions in the “Disassembling the Firearm for Cleaning” section of this manual.
2. Spray the Slide with Rem Action Cleaner, including the breech face, barrel channel, rail cuts, disconnecter cut, and ejector clearance cut. See Figure 26.
3. If necessary, use a nylon brush to remove any fouling residue.

4. Wipe the Slide with a clean patch and allow to air dry.
5. Spray the inside of the Slide with Rem Oil. Ensure the rail cuts, cartridge ramp, and barrel channel are well lubricated.
6. Apply a light coating of Rem Oil to the outside of the Slide with a soft clean cloth.

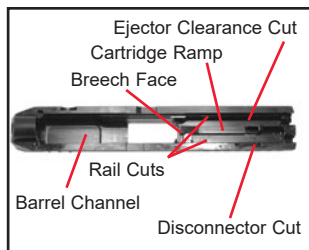

Figure 26

## CLEANING THE FRAME ASSEMBLY

**WARNING!** Unload the firearm before cleaning and/or servicing. See the “Clearing/Unloading Your Firearm” section of this manual. Always wear eye protection when handling, disassembling and reassembling the firearm. Failure to follow these instructions may cause property damage, personal injury, and/or death.

**NOTE:** Clean and lubricate the Frame as an assembly. Do not remove any additional components from the Frame Assembly. Any further disassembly should only be completed by a Remington Authorized Repair Center.

1. Disassemble the firearm following the instructions in the “Disassembling the Firearm for Cleaning” section of this manual.
2. Spray the Frame Assembly with Rem Action Cleaner.
3. Use a brush to remove any fouling residue, if necessary.
4. Wipe the Frame Assembly with a clean patch and allow to air dry.
5. Apply a light coating of oil to the inside of the Frame Assembly. Include around the Fire Control and Slide Rails. See Figure 27.

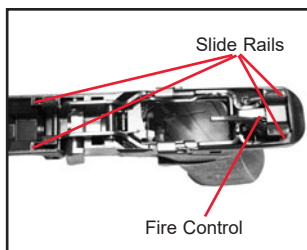

Figure 27

## REASSEMBLING THE FIREARM

**WARNING!** The firearm owner and user must accept full responsibility for the correct reassembly and functioning of the firearm after the disassembly or the replacement of parts. Incorrectly assembling the firearm or the use of modified or incorrect parts can result in property damage, personal injury, and/or death.

**NOTE:** Remington recommends all service and replacement of components be performed by a Remington Authorized Repair Center. If a repair or component replacement was not completed by a Remington Authorized Repair Center, we recommend that you have your firearm checked by an Authorized Repair Center to verify your firearm is operating properly and safely.

**CAUTION!** Always wear eye protection when handling, disassembling and reassembling the firearm. Failure to follow these instructions may



cause property damage and/or personal injury.

1. Insert the Barrel into the Slide. See Figure 28.
2. Seat the Barrel into the slide. See Figure 29.
3. Insert the front of the Recoil Spring/Guide Rod Assembly into the Slide. See Figure 30.
4. Compress the Recoil Spring slightly and seat against the Barrel. See Figure 31.
5. Align the rail cuts on the Slide with the Slide Rails on the Frame and push the Slide Assembly onto the Frame. See Figure 32.
6. Pull the Slide fully rearward and lock it in the open position by pushing the Slide Stop up, fully engaging the slide stop notch. See Figure 33.
7. Push rearward on the bottom of the Take Down Lever rotating it counter clockwise 90°. See Figure 34.
8. Once the Take Down Lever is snapped into position, release the Slide Stop and allow the Slide to move fully forward.

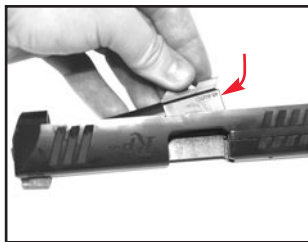

Figure 28

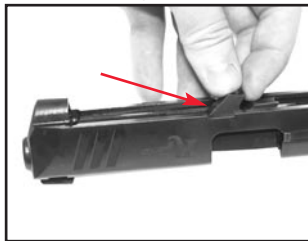

Figure 29



Figure 30

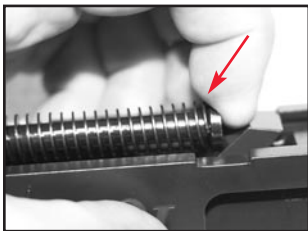

Figure 31

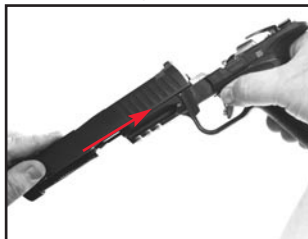

Figure 32



Figure 33



Figure 34

## FUNCTION TESTING THE FIREARM

**WARNING!** If the firearm experiences a malfunction during the Function Test, the firearm is not safe to use. This firearm should be serviced by a Remington authorized repair center. See the “How to Obtain Parts and Service From Remington” section of this manual to have your firearm repaired. Use of a firearm which fails the Function Test may cause property damage, personal injury, and/or death.

When the firearm is reassembled, a short function test should be conducted to ensure proper operation before loading or discharging the firearm. If the firearm does not function as described in any of the Function Testing, the firearm is NOT in a safe operating condition and it must NOT be used until you have it inspected by a Remington Authorized Repair Center or call the consumer service number, 1-800-243-9700, Mon.-Fri., 9:00 AM-5:00 PM Eastern Standard Time.

**WARNING!** Unload the firearm before function testing. See the “Clearing/Unloading Your Firearm” section of this manual. Always wear eye protection when handling, disassembling and reassembling the firearm. Failure to follow these instructions may cause property damage, personal injury, and/or death.

1. Always keep the firearm pointed in a safe direction. See *The Ten Commandments of Firearm Safety* section of this manual.
2. Verify the firearm is completely unloaded. See the “Clearing/Unloading the Firearm” section of this manual.
3. While holding the firearm with your shooting hand, and keeping the Trigger clear of contact with fingers and/or other objects, pull the Slide fully rearward and release.
4. Pull the Trigger without depressing the Trigger Safety. The Striker should not release or fall (NO audible click).
5. Pull the Trigger while depressing the Trigger Safety. The Striker should release (audible click). Keep the Trigger fully depressed.
6. While holding the firearm with your shooting hand and keeping the Trigger fully depressed, pull the Slide fully rearward and release. The Striker should not release or fall.
7. Fully release the Trigger then pull the Trigger. The Striker should release (audible click).
8. Insert an empty magazine into the magazine well.
9. While holding the firearm with your shooting hand, pull the Slide fully rearward and release. The slide should not move forward.
10. Remove the magazine by pushing the magazine release.
11. If the firearm does not function as described in any of the Function Testing, the firearm is NOT in a safe operating condition and it must NOT be used until you have it inspected by a Remington Authorized Repair Center or call the consumer service number, 1-800-243-9700, Mon.-Fri., 9:00 AM-5:00 PM Eastern Standard Time.

**WARNING!** The firearm owner and user must accept full responsibility for the correct reassembly and functioning of the firearm after the disassembly or the replacement of parts. Incorrectly assembling the firearm or the use of modified or incorrect parts can result in property damage, personal injury, and/or death.

**NOTE:** Remington recommends all service and replacement of components be performed by a Remington Authorized Repair Center. If a repair or component replacement was not completed by a Remington Authorized Repair Center, we recommend that you have your firearm checked by an Authorized Repair Center to verify your firearm is operating properly and safely.

### **Firearm Sale or Transfer:**

If your firearm has been adjusted or changed in any way and you intend to sell or otherwise transfer possession of your pistol, you must: 1) provide a complete service record, (2) warn the purchaser or recipient of your firearm that it has been adjusted or modified, and (3) give the purchaser or recipient this owner's manual for review and reference. If you do not wish to sell or transfer your pistol in an adjusted condition (recommended), return it to a Remington Authorized Repair Center for restoration of your pistol to the original factory conditions. Do Not attempt to restore the pistol to factory conditions yourself.

**WARNING! NEVER** alter or modify any part of the firearm. Improper alterations can make the pistol unsafe and result in property damage, personal injury and/or death.

This firearm should not be sold where prohibited by federal, state or local laws.

All rights to this instruction manual are reserved. The information in this document is subject to change without notice. Remington reserves the right to change the content herein without the obligation to notify any person or organization of such changes.

Remington®, RP®, BriteBore®, Barnes®, and Rem® are trademarks of RA Brands, L.L.C. or its affiliates and may not be used in any way without the express written consent of Remington. All other trademarks used herein remain the exclusive property of their respective owners. Nothing contained in this manual should be construed as granting, by implication or otherwise, any license to trademarks displayed herein. Misuse of any trademarks or any content of this manual is strictly prohibited. Remington shall aggressively enforce its intellectual property rights to the fullest extent of the law.

# MODEL RP Series Semiautomatic Pistol

## Exploded View

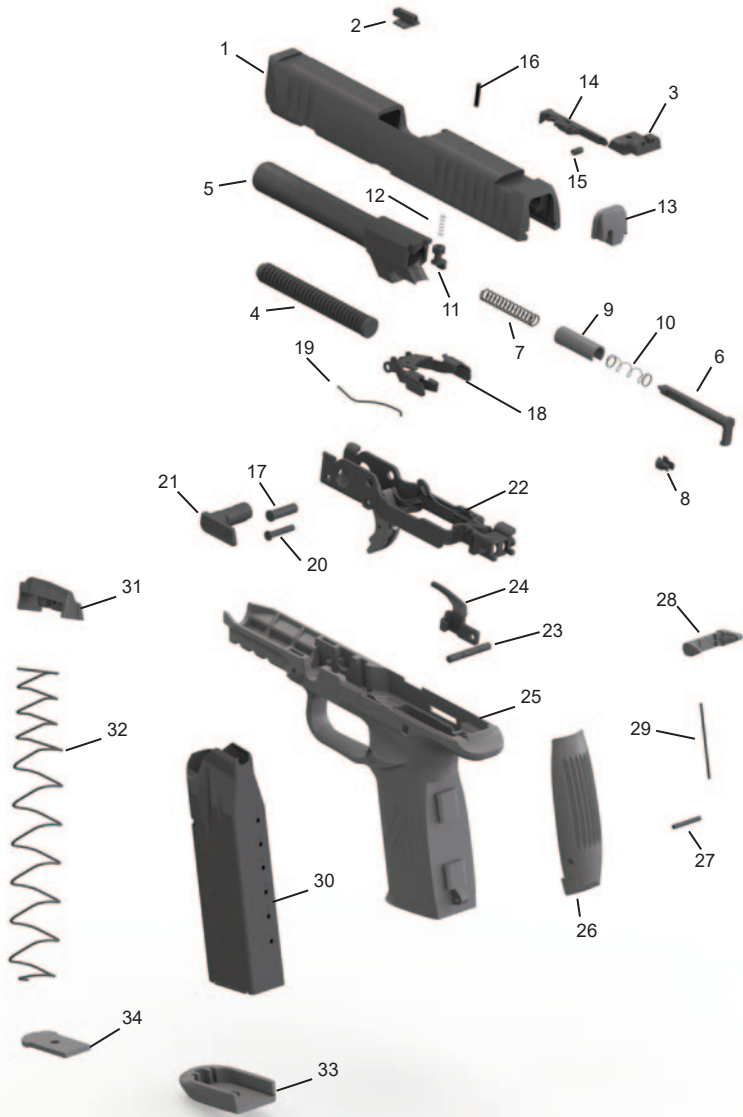

Schematic is provided for part identification only and should not be used as a guide to assemble the firearm.

# MODEL RP Series Semiautomatic Pistol

## Parts List

<b>ITEM NO.</b>	<b>PART NAME</b>
1	Slide
2	Front Sight
3	Rear sight
4	Recoil Spring/Guide Rod Assembly
5	Barrel
6	Striker
7	Striker Spring
8	Striker Spring Keeper
9	Striker Spring Sleeve
10	Striker Return Spring
11	Striker Safety
12	Striker Safety Spring
13	Slide Cover Plate
14	Extractor
15	Extractor Spring
16	Extractor Pivot Pin
17	Barrel Unlock Pin
18	Slide Stop
19	Slide Stop Spring
20	Slide Stop/Trigger Pivot Pin
21	Take Down Lever
22	Frame Assembly
23	Frame Retaining Pin
24	Ejector
25	Grip Housing
26	Back Strap
27	Back Strap Retaining Pin
28	Magazine Catch
29	Magazine Catch Spring
30	Magazine Tube
31	Magazine Follower
32	Magazine Spring
33	Magazine Base Plate
34	Magazine Base Plate Retainer

# HOW TO OBTAIN PARTS AND SERVICE FROM REMINGTON

**NOTE:** Remington recommends all service and replacement of components be performed by a Remington Authorized Repair Center. If a repair or component replacement was not completed by a Remington Authorized Repair Center, we recommend that you have your firearm checked by an Authorized Repair Center to verify your firearm is operating properly and safely.

## To Order Parts:

To order parts please visit Remington's website @ [www.remington.com](http://www.remington.com) or call 1-800-243-9700. For additional information on service enhancements, upgrades, repair, additional barrels, and specialty parts visit [www.remington.com](http://www.remington.com).

To place an order or for additional information on service enhancements, upgrades, and additional barrels, please call us toll free consumer service number, 1-800-243-9700, Mon.-Fri., 9:00 AM-5:00 PM Eastern Standard Time.

1. Fax completed order form (from the catalog) to 1-336-548-7711.
2. To order by phone without the order form call 1-800-243-9700.

## Please have the following information ready before you call.

- Firearm model and serial number.
- Part description and quantity. Part descriptions can be found on the parts listing page 30 in this manual.
- Your complete mailing address (P.O. Box and Street Address) including zip code, telephone number and e-mail address.
- Method of payment: MasterCard, Visa, Amex or Discover card number and expiration date. A quote may be made to you over the phone. (Sorry, no C.O.D.s.)

**WARNING!** Use only Remington parts in Remington firearms. Failure to follow these instructions may lead to property damage, personal injury, and/or death.

**NOTE:** Some parts may be restricted. See parts list for details. Owner's manuals/instruction books may be requested via our web site at: [www.remington.com](http://www.remington.com) or by calling 1-800-243-9700.

## Repair Services:

If there is a defect with your Remington firearm that (i) you believe is, or

should be, covered by the Warranty, (ii) you would like Remington to address at your cost and expense, or (iii) you would otherwise like to discuss with Remington, please contact Remington Consumer Services at 1-800-243-9700, Mon.-Fri., 9:00 AM-5:00 PM Eastern Standard Time. Please do not send your firearm or other item to Remington without first (a) calling this number, (b) receiving instructions from the Remington representative, and (c) obtaining a Service Request document containing your Service Repair Number. With regards to the Service Request document, Remington will either e-mail this document to you or, if you do not have an e-mail address, Remington will mail it to you. Please be sure to store your Service Request document in your records so that it is both safe and accessible. Finally, to the extent you seek Warranty coverage, please review the Warranty for your Remington firearm and note that you may void your Warranty by taking action without first contacting Remington.

To review the warranty and register, please visit our website at: [www.remington.com/support/firearm-warranty-information](http://www.remington.com/support/firearm-warranty-information).

If shipment of your firearm is required, an SRN must be obtained prior to shipment and please follow the instructions below:

- Record the serial number of your firearm before shipping.
- Pack your firearm for safety and to prevent further damage in shipping and handling. Preferably, ship in a firearms box.
- Remove all accessories from the firearm to prevent loss or damage.
- Enclose the filled out return form with your firearm. The return form can be found at [www.remington.com](http://www.remington.com) or call Remington at 1-800-243-9700 to request a copy of the form. Be sure to include your full name and address (P.O. Box and Street Address), including zip code, day-time telephone number and e-mail address.
- Place your SRN on the shipping label
- Check your government guidelines before shipping.
- Remington is not responsible for damage or loss during shipment. You may elect to purchase insurance from your carrier.

**WARNING!** Do not send live ammunition or spent shells in your firearm or in the same box with the firearm. If you feel you must send spent shells, please send them in a separate package and include your name, address (with zip code), telephone number, model and serial number of your firearm.

# Firearm Owner's Record

Model: \_\_\_\_\_

Serial No. \_\_\_\_\_

Date Purchased: \_\_\_\_\_

Purchased From: \_\_\_\_\_

Price Paid: \_\_\_\_\_

This instruction manual should always accompany this firearm and be transferred with it upon change of ownership.

## **FIREARMS WARRANTY and REGISTRATION**

If you seek Warranty coverage, please review the Warranty for your Remington firearm and note you may void your warranty by taking action without first contacting Remington. For instructions on how to obtain Warranty coverage, see "Repair Services" on page 30.

Please take a moment right now to register ONLINE to obtain the full benefit of your Limited Lifetime Firearm Warranty.

To review the Warranty and to register, please visit our website at:

<http://www.remington.com/support/firearm-registration>

*Your firearm has been designed to operate according to certain factory specifications.* You'll jeopardize your safety and that of others around you by attempting to alter its trigger, mechanical safety or other mechanisms. Never alter or modify your firearm in any way.

*Like any mechanical device, a firearm is subject to wear.* It must be maintained and periodically serviced to assure optimum safety and performance. Only a qualified service facility should service, repair or modify your Remington firearm. Consult [www.remington.com](http://www.remington.com) for the location of the nearest Authorized

Remington Repair Center. *Remington recommend that you have your firearm professionally serviced annually.* You should also have your firearm professionally serviced after prolonged storage, or if there is ever any question pertaining to the proper functioning characteristics of your firearm.

*Proper cleaning and lubrication are also important to firearm maintenance and are necessary to assure accuracy, safety and reliability.* Before cleaning, always make sure that your firearm is completely unloaded. And always clean the barrel from the chamber end to the muzzle when possible.







NOTES:

**MODEL RP Series  
Autoloading Pistols**

*Remington*®