

Remington.

OWNER'S MANUAL



Instruction Book for:

RM380™

Semi-Automatic Pistol

This manual contains operating, care, and maintenance instructions. To assure safe operation, any user of this firearm must read and understand this manual before using the firearm. Failure to follow the instructions and heed the warnings in this manual can cause property damage, personal injury, and/or death. This manual should always accompany this firearm, and be transferred with it upon change of ownership.

WARNING! Keep this firearm out of the reach of children, unauthorized individuals, and others unfamiliar with the safe handling of firearms.



Alert Symbols and Definitions:

WARNING!

Indicates a hazardous situation which, if not avoided, will result in property damage, personal injury or death.

Caution!

Indicates a hazardous situation which, if not avoided, could result in minor to moderate personal injury.

NOTE:

Address practices not related to personal injury.

Congratulations on Your Choice of a Remington Pistol.

Remington would like to thank you for purchasing our product. With proper care, it should give you many years of dependable use and enjoyment. For best results, we recommend that you use Remington or Barnes Ammunition; the ammunition used in factory testing your firearm against our rigorous function and performance standards.

Contents:

Page 3	Safety is Critical to Performance
Page 3	The Ten Commandments of Firearm Safety
Page 9	Safe Firearm Handling
Page 9	Dangerous Procedures
Page 10	General Operation
Page 11	Important Parts of the Firearm
Page 11	The Serial Number and Caliber Identification
Page 11	Chamber Indicator
Page 12	The Slide Stop
Page 12	The Locking Device
Page 13	The Magazine Release
Page 13	The Trigger Assembly
Page 13	Clearing/Unloading the Firearm
Page 15	Checking the Barrel for Obstructions
Page 15	Removing Obstructions from the Barrel
Page 15	Loading the Firearm
Page 16	Ammunition
Page 18	Discharging the Firearm
Page 19	Cleaning, Lubrication, and Maintenance
Page 20	Disassembling the Firearm for Cleaning
Page 22	Cleaning/Reassembling the Magazine
Page 23	Cleaning the Barrel
Page 24	Cleaning the Recoil Spring/Guide Rod Assy.
Page 24	Cleaning the Firing Pin Assembly
Page 24	Cleaning the Slide Assembly
Page 25	Cleaning the Frame Assembly
Page 25	Reassembling the Firearm
Page 27	Function Testing the Firearm
Page 29	To Replace the Firearm Grips
Page 31	RM Autoloading Pistol; Exploded View
Page 32	RM Autoloading Pistol; Parts List
Page 33	How to Obtain Parts and Service
Page 35	Owner's Record / Warranty and Registration

Safety is Critical to Performance.

A superbly crafted firearm is only as good as the hands that hold it. You can never be too careful. Shooting accidents are often caused by careless oversights such as failing to control the direction of the muzzle, failing to fully engage the safety, leaving ammunition in the chamber, or using improper loads. These oversights can result in the destruction of life, limb, or property. There is no calling back a bullet once it has been fired, so it is critical that you know the principles of safe firearm handling and storage before you ever take your new firearm out of the box.

The proper use and performance of your firearm depends on correct assembly and maintenance, so it is critical that you familiarize yourself with the information in this manual. Even if you are a veteran shooter with a collection of firearms, take the time to read this manual. Not all firearms are the same. That means the first step in safe handling is to learn and become familiar with the features and requirements of your new firearm.

THE TEN COMMANDMENTS OF FIREARM SAFETY

The Ten Commandments of Firearm Safety should be etched in your memory forever. Let them govern your action wherever and whenever you are involved with firearms in the field, on the range, or in your home. Please take the time to review and understand these rules.



1st C O M M A N D M E N T

ALWAYS KEEP THE MUZZLE POINTED IN A SAFE DIRECTION.

This is the most important firearm safety rule. A safe direction is one in which an accidental discharge will not cause injury to yourself or others. Never allow your firearm to point at anything you do not intend to shoot. Be especially careful when you are loading or unloading. Treat every firearm as if it were loaded. And make it a habit to know where the muzzle is pointed at all times, even when your firearm is unloaded. No one will be injured by an accidental discharge if you keep your firearm pointed in a safe direction. It is that simple.





2nd C O M M A N D M E N T

FIREARMS SHOULD BE UNLOADED WHEN NOT IN USE.

Load your firearm only when you are in the field or on the target range and ready to fire. Never let a loaded firearm out of your sight or out of your hands. Unload it as soon as you are finished shooting - before you bring it into your car, camp or home. Remember, unloading your firearm means unloading it completely, so there is no ammunition in the chamber or in the magazine. Before handling a firearm or passing it to someone else, visually check the chamber, receiver and magazine to be certain they do not contain ammunition. Always keep the firearm's action open when not in use. Never assume a firearm is unloaded even if you were the last person to use it. Always check for yourself.

- Let common sense rule when you carry a loaded firearm. If you are in a situation that could risk accidental discharge - such as crossing a fence, wading through a stream or climbing a tree - always unload your firearm. Never pull or push a loaded firearm toward yourself or another person. Never carry a loaded firearm in a scabbard, detached holster or gun case.

- Certain firearms are equipped with internal security devices to prevent unauthorized use. Some firearm owners use external devices, such as cable locks and trigger blocks, for the same purpose. Even if you use such a device, you should still keep your firearm unloaded when stored or not in use. Using internal or external devices cannot substitute securing your firearm and ammunition in separate, locked locations.

- Safe storage of firearms is just as critical as safe handling. Never store firearms loaded. Be sure to keep your firearm in a secure place where unauthorized persons cannot get their hands on them without your knowledge.

- Take special care if there are children around. Children are fascinated by firearms. It is a natural curiosity that can have tragic consequences when not properly supervised. Store your firearm in a locked gun safe or some other location that physically bars a child from gaining access.

- Ammunition should be stored and locked in a location separate from your firearm. Never leave an unsecured firearm or ammunition in a closet, dresser drawer or under the bed. Remember, it is your responsibility to make sure that children and others unfamiliar with firearms cannot get access to your firearm and ammunition.



Firearms should be stored in a secure place where children cannot access them. A gun safe is an ideal way to secure your firearm.



3rd C O M M A N D M E N T

DO NOT RELY ON YOUR FIREARM'S SAFETY.

Treat every Firearm as if it can fire at any time, whether or not there is pressure on the trigger. Your firearm has been carefully designed to maximize performance and safety. However, because a firearm's safety is a mechanical device, it could fail.

Human error is a more likely reason for a firearm safety to fail. By mistake, you may think the safety is on when it really is not. Or the safety may have been disengaged

without your knowledge. Or you could think your firearm is unloaded when there is actually a cartridge or shell in it. A mechanical safety is not a substitute for common sense. It is merely a supplement to your proper handling of a firearm.

Never touch the trigger on a firearm until you are ready to shoot. Keep your fingers away from the trigger when you are loading or unloading. And do not pull the trigger when the safety is engaged or positioned between safe and fire.

Before using your firearm, read this instruction book to understand the exact location and operation of your firearm's safety. Even when the safety is on, maintain control of your loaded firearm and control the direction of the muzzle. In other words, do not rely on your safety to justify careless handling. If your firearm's internal mechanisms are broken or have been altered, your firearm may fire even when the safety is on. Remember, you and your safe firearm handling practices are your firearm's best safety.



4th COMMANDMENT

BE SURE OF YOUR TARGET AND WHAT IS BEYOND IT.



You can not stop a shot in mid-air, so never fire unless you know exactly where your shot is going and what it will strike. Never fire at a sound, a movement or a patch of color. A hunter in camouflage can easily be mistaken for a target by an impulsive shooter. Before you pull the trigger, be absolutely sure of your target and what is behind it. Make sure

the shot has a backstop such as a hillside or dense material like sand. Remember, bullets can travel great distances with tremendous velocity. Know how far your shot will go if you miss your target or the bullet ricochets.



5th COMMANDMENT

USE PROPER AMMUNITION.

Every firearm is designed to use a certain caliber or gauge of ammunition. Using the wrong ammunition, mixing ammunition or using improperly reloaded ammunition can cause serious personal injury or death. And it only takes one cartridge or shotshell of the incorrect caliber or gauge, or which has been improperly reloaded, to destroy your firearm.

It is your responsibility to make sure the ammunition you use exactly matches the caliber or gauge of your firearm. Refer to this instruction book to find out the specific requirements of your firearm. Always read and heed the instructions on ammunition boxes.

Confusing shells or cartridges can cause serious personal injury or death and destroy your firearm. Examine your shells or cartridges closely and use only the precise caliber or gauge for your specific firearm. For example, suppose you accidentally loaded a 20 ga. shell into a 12 ga. shotgun. Because the 20 ga. shell is too small for the chamber, the 20 ga. shell could travel down the barrel and get lodged in the bore. If you then loaded a standard 12 ga. shell behind it and fired, the 12 ga. shot will slam into the lodged 20 ga. shell and may cause the barrel to explode right in your hand.

This is commonly called a 12/20 burst, and it can kill you. Check all ammunition before you load it to make sure it matches your firearm's requirements. Typically every firearm cartridge and shell is head-stamped with its caliber or gauge for easy identification. Likewise, you will find the caliber or gauge of your new Remington firearm imprinted on the barrel.

6th C O M M A N D M E N T

IF YOUR FIREARM FAILS TO FIRE WHEN THE TRIGGER IS PULLED, HANDLE WITH CARE

If for some reason the ammunition does not fire when you pull the trigger, stop and remember the 1st Commandment of Firearm Safety - always keep the muzzle pointed in a safe direction. After waiting a minimum of one minute, keep your face away from the breech, put the safety on, carefully open the action, unload the firearm, and dispose of the cartridge safely. Remember that any time there is a shell in the chamber your firearm is loaded and ready to use. Even if you tried to shoot and your firearm did not fire, treat your firearm as if it could still discharge.

7th C O M M A N D M E N T

ALWAYS WEAR EYE AND EAR PROTECTION WHEN SHOOTING.

Your sight and hearing risk injury from shooting and should be protected at all times. Wear protective shooting glasses to guard against falling shot, clay target chips, powder residue, ruptured cartridge cases and even twigs and branches in the field. Also be sure to wear eye protection when you are disassembling or cleaning a firearm so that tensioned parts (like springs) and cleaning solvents do not come in contact with your eyes. Continued exposure to shooting noise can permanently damage your hearing. On the range, where shooting volume is the loudest, be sure to use the maximum protection of a headset. Learn to use ear protection at all times.



8th C O M M A N D M E N T

BE SURE THE BARREL IS CLEAR OF OBSTRUCTIONS BEFORE SHOOTING.

Before loading your firearm, open the action and make sure there is no ammunition in the chamber or magazine. Check the barrel for any obstructions or debris. Even a small amount of snow, mud, excess lubricant or grease in the bore can dangerously increase pressure and cause the barrel to bulge or burst when firing. Use a cleaning rod and patch to wipe away anti-rust compounds or any other residues or obstructions in the barrel. Never try to shoot out an obstruction by loading another shell and firing!

When firing, rely on your instincts. If the noise or recoil of your firearm seems weak, stop everything, unload your firearm and be sure nothing is lodged in the barrel. Remember the 12/20 burst? That is what can happen when the barrel is obstructed. Always be sure you are using the correct ammunition in your firearm and that it is free of obstructions.



9th C O M M A N D M E N T

DO NOT ALTER OR MODIFY YOUR FIREARM AND HAVE IT SERVICED REGULARLY.

Your firearm has been designed to operate according to certain factory specifications. You will jeopardize your safety and that of others around you by attempting to alter its trigger, mechanical safety or other mechanisms. So never alter or modify your firearm in any way.

Like any mechanical device, a firearm is subject to wear. It must be maintained and periodically serviced to assure optimum safety and performance. Only a qualified service facility should service, repair or modify your firearm. Consult your instruction book for instructions on how to send your firearm to the factory or for the location of the nearest Remington authorized repair station. Proper cleaning and lubrication are also important to firearm maintenance and are necessary to assure accuracy, safety and reliability. Before cleaning, always make sure that your firearm is completely unloaded. And always clean the barrel from the chamber end to the muzzle when possible.

Make it a practice to clean your bore every time you are going to shoot. Be sure to clean your entire firearm before and after long-term storage and no less than once a year. It is also important to clean your firearm whenever it has been exposed to adverse conditions such as rain, dirt, mud, snow, sleet or saltwater.



For safe and dependable operation of your firearm, all parts of your firearm must be properly cleaned and lubricated. Periodically inspect the internal workings of your firearm to be sure they are clean and free of rust, unwanted dirt and debris.

Use recommended lubricants on your firearm and do not over-lubricate. Excessive use of a non-recommended lubricant could adversely affect the function and safe operation of your firearm. Remember, you are responsible for the proper care and maintenance of your firearm. Failure to properly maintain your firearm cannot only damage or ruin your firearm, it can expose you and others to unnecessary risks of personal injury or death.

Remington has a wide range of firearm care products and resources for best results when cleaning your firearm; everything from solvents and lubricants to rods and patches. They are all available from your Remington dealer.



10th C O M M A N D M E N T

LEARN THE MECHANICS AND HANDLING CHARACTERISTICS OF YOUR FIREARM.

Not all firearms are alike. They have different mechanical characteristics that dictate how you should carry and handle them. Anyone who plans to use a firearm should first become totally familiar with the type of firearm it is and the safe handling procedures for loading, unloading, carrying, shooting and storing it.

Before you even unpack your new firearm, read this instruction book from cover to cover and familiarize yourself with the different component parts of the firearm. Then read, understand and follow *The Ten Commandments of Firearm Safety* in this manual.

WARNING! Discharging firearms in poorly ventilated areas, cleaning firearms or handling ammunition may result in exposure to lead, a substance known to cause birth defects, reproductive harm, cancer and other serious physical injury. Have adequate ventilation at all times. Wash hands thoroughly after exposure.

SHOOT SOBER!

There is one other rule that must be followed when handling firearms. In fact, respect for this rule is necessary in order to effectively practice the Ten Commandments of Firearm Safety. The rule is: SHOOT SOBER! Firearms and alcohol or drugs make a deadly combination. Never consume anything that would mildly impair your judgment or physical coordination when you are using a firearm. A staggering percentage of the shooting accidents that occur every year involve alcohol or drugs. Be smart. Always shoot sober and stay alive.

WARNING! Failure to follow any of these safety rules may cause personal injury or death to the shooter or bystander and damage to property. Do not use a firearm until you fully understand and practice *The Ten Commandments of Firearm Safety*. If you have any questions about the safe use of a Remington firearm, write to us at Remington, Consumer Service, P.O. Box 1911, Madison, NC 27025-0700, or call us at 1-800-243-9700.

DON'T KEEP THIS TO YOURSELF.

Now that you are a firearm owner you have the obligation to help ensure that shooting sports are safe for everyone, participants and bystanders alike. You can do that by practicing these principles of firearm safety and passing them on to others - especially new shooters. Set an example for beginners. Be a guide to their safe entry into the exciting world of shooting sports. Invest your time and patience for the love of the sport and for its future. After all, it is your love of the sport that led you to buy a new firearm.

Firearm ownership is a right and privilege. It is a privilege, which carries with it a personal responsibility to use your firearm in a way which will ensure your safety and the safety of others. The preservation of this right and privilege depends on the personal commitment of you and your fellow shooters to the safe and responsible use of firearms. Let *The Ten Commandments of Firearm Safety* outlined in the book guide you at all times. Teach and promote these rules whenever you can. Remember, firearm safety depends on you! That is the only way to really enjoy your new firearm and to preserve sport shooting as we know it today.

MODEL RM SEMIAUTOMATIC PISTOLS

ALWAYS PRACTICE SAFE FIREARMS HANDLING

WARNING! It is very important that you read and understand this manual before using the new firearm. Each of the warnings should be read and heeded carefully. Always follow *The Ten Commandments of Firearm Safety* listed in this manual. Failure to follow these rules, warnings, and instructions, can result in property damage, personal injury, and/or death.

WARNING! If this firearm is carelessly or improperly handled, unintentional discharge can result in property damage, personal injury, and/or death.

WARNING! Use only clean, dry, high quality, commercially manufactured ammunition in good condition which is appropriate to the caliber of your firearm. Remington recommends against the use of remanufactured or hand loaded ammunition. The use of improperly loaded or reloaded ammunition may cause property damage, personal injury, and/or death.

DANGEROUS PROCEDURES

WARNING! This firearm may inadvertently chamber a cartridge if it is dropped or jarred with a loaded magazine in place. An unintentional discharge of a firearm may cause property damage, personal injury, and/or death.

WARNING! An unfired cartridge can discharge if left in a hot barrel, this is often referred to as a "cook-off". Always keep the firearm pointed in a safe direction. If an unfired cartridge cannot be cleared from a hot barrel quickly, remove the magazine from the firearm and allow the barrel and unfired cartridge to cool 15 minutes. A cook-off can cause property damage, personal injury, and/or death.

WARNING! Never discharge a firearm with water or an obstruction in the barrel. Discharging the firearm with water or other obstructions in the barrel can cause property damage, personal injury, and/or death.

WARNING! If you experience a change in sound report and/or recoil while discharging the firearm, do not attempt to discharge the firearm again. A change in sound report and/or recoil can be symptoms of a defective cartridge, which could lead to an obstructed bore. Discharging a firearm with an obstructed bore can cause property damage, personal injury, and/or death.

THANK YOU FOR BUYING A REMINGTON PRODUCT

Congratulations on your choice of the Remington RM Pistol. With proper care, it should give you many years of dependable use and enjoyment. For best results, we recommend that you use Remington or Barnes Ammunition - the ammunition used to test your RM against our rigorous function and performance standards.

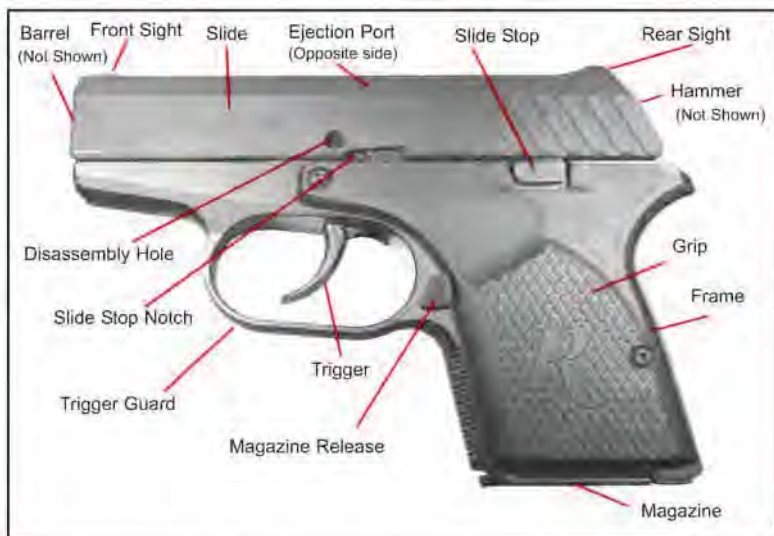

FIGURE 1 This picture shows the main parts of a MODEL RM Series Pistol. The picture will aid in understanding the instructions.

GENERAL OPERATION

The Model RM series handguns are tilt barrel, locked breech, hammer initiated with a double action only (DAO) trigger system, autoloading pistols. The RM handguns are capable of firing successive shots with each pull of the trigger. Once the last cartridge in the magazine is discharged and ejected, the slide will remain in the open position.

NOTE: Some illustrations in this manual may depict cosmetic differences not related to performance or safety.

IMPORTANT PARTS OF THE FIREARM

THE SERIAL NUMBER AND CALIBER IDENTIFICATION

The serial number is located on the shooter's right side of the Frame, below the Slide. See Figure 2.

The RM's caliber and cartridge designation is located on the Barrel. The marking is visible through the ejection port when the slide is fully forward. See Figure 3.

WARNING! Only use ammunition designated on the Barrel. Using ammunition not designated on the Barrel (improper caliber) may cause property damage, personal injury, and/or death.

THE CHAMBER INDICATOR

The Chamber Indicator is located at the rear of the barrel seen through the ejection port. See Figure 4. Observing the Chamber Indicator opening allows the user to observe if brass is present, indicating a chambered cartridge, providing there is adequate lighting and the handgun is clean and in good working order. Never rely on the Chamber Indicator alone to determine if a cartridge is chambered. Always open the slide and visually check the chamber and magazine to verify the presence of a cartridge. See "Clearing/Unloading the Firearm" in this manual.

WARNING! Do NOT rely upon the chamber indicator alone to verify the presence or absence of a cartridge in the chamber. See *The Ten Commandments of Firearm Safety* in this manual. The Chamber Indicator may help to determine whether a cartridge is present in the chamber. The lighting conditions, cleanliness of the handgun, discoloration of the ammunition, and other factors may limit the effectiveness of the Chamber Indicator. Failure to follow safe firearm handling practices may cause property damage, personal injury, and/or death.



Figure 2



Figure 3

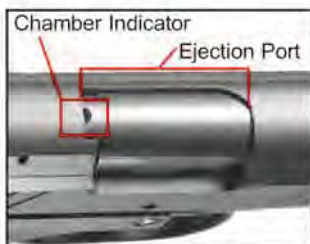

Figure 4

ADDITIONAL FEATURES

The RM pistol incorporates passive features providing additional protection against accidental or unintentional discharge during normal usage when in good working order. These passive features, such as the steel alloys and/or their metallurgical treatments or properties, the double action trigger, hammer, and the firing pin systems, the trigger and sear engagements, the lock-up system along with the trigger guard all work without direct input from the user as long as your firearm is kept clean and in good working order.

WARNING! Do not alter, bypass, or render the safety features of this firearm inoperative. Altering, bypassing, or rendering these features inoperative may cause property damage, personal injury, and/or death.

THE SLIDE STOP

The Slide Stop located on the shooter's left works in conjunction with the slide stop notch located in the Slide. It is used to hold the slide in the rear position. An engaged Slide Stop allows for easy access and inspection of the chamber, breech face, and magazine. See Figure 5.

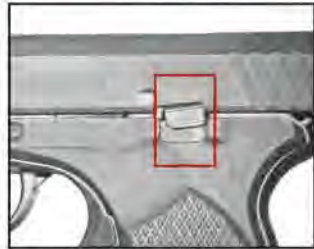

Figure 5

THE LOCKING DEVICE

This firearm was originally sold with a key-operated locking device to assist the owner in protecting against unauthorized use. For proper installation of the locking device, see separate instructions provided with the locking device. These are storage locking devices. Keep your locking device engaged when your firearm is not in use. See Figure 6. Store the pistol unloaded and locked in a safe place. Store the ammunition and key separately from the pistol.



Figure 6

WARNING! The locking device does not eliminate the need for safe firearm handling and storage, including keeping this and every firearm unloaded and locked in a secure place when not in use. Read and follow these and other safety rules in this instruction book. See *The Ten Commandments of Firearm Safety* section of this manual. Failure to read, understand, and obey these instructions may cause property damage, personal injury, and/or death.

THE MAGAZINE RELEASE

The Magazine Release button is used to release the magazine from the firearm. The Magazine Release Button can be accessed from either side of the pistol. It is located behind the trigger. To release a magazine from the pistol, depress the Magazine Release button. See Figure 7.



Figure 7

THE TRIGGER ASSEMBLY

Pulling the trigger DISCHARGES the firearm.

The RM handgun Trigger Assembly incorporates a double action only (DAO) trigger. The Trigger Assembly is not adjustable. All repairs to the Trigger Assembly must be made by a Remington Authorized Repair Center.

WARNING! Never place your finger on the trigger unless you are ready to discharge or FIRE the firearm. An unintentional or uncontrolled discharge of your firearm may cause property damage, personal injury, and/or death.

WARNING! Never manipulate, adjust or change any of the internal components of your firearm unless specifically directed to do so in this instruction manual. Improper manipulation of any internal component may affect the safety and reliability of your firearm and may cause property damage, personal injury, and/or death.

CLEARING / UNLOADING THE FIREARM

WARNING! Never assume your firearm is unloaded. Always control the direction of the muzzle of your firearm, even if you think it is completely unloaded. Careless handling of a firearm may cause property damage, personal injury, and/or death.

WARNING! RM Series handguns can be discharged with the magazine removed. If a cartridge is chambered, and the Slide is closed, pulling or depressing the Trigger will cause the firearm to discharge. An unintentional or uncontrolled discharge of your firearm may cause property damage, personal injury, and/or death.

WARNING! Always wear eye and hearing protection when handling a loaded firearm. Failure to do so could result in personal injury. See *The Ten Commandments of Firearm Safety* section of this manual.

1. Always keep the firearm pointed in a safe direction. See *The Ten Commandments of Firearm Safety* section of this manual.
2. Remove the magazine by pressing the Magazine Release Button. See Figure 7.
3. Firmly hold the firearm with your shooting hand, while keeping the Trigger clear of contact with fingers and/or other objects.

4. Pull and hold the Slide fully rearward with your support hand. If a cartridge was in the chamber, it should be ejected at this time. See Figure 8.
5. With the Slide fully rearward, lock the Slide in the open position by pushing the Slide Stop up, fully engaging the Slide Stop notch. See Figure 9.
6. Look into the ejection port and visually check the chamber and magazine well for cartridges, making sure the handgun is completely unloaded.
7. Check the Breech Face ensuring the Firing Pin is not protruding. See Figure 10. If the Firing Pin is protruding from the Breech Face as in Figure 10b, do not attempt to load or discharge the firearm. Have the firearm inspected by a Remington Authorized Repair Center before use.



Figure 8



Figure 9



Figure 10

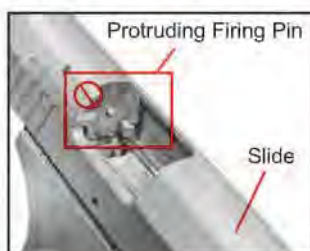

Figure 10b

WARNING! If the firing pin is protruding from the breech face do NOT attempt to load or discharge the firearm. Have the firearm serviced by an Authorized Repair Center. See "How to Obtain Parts and Service from Remington" section in this manual. Loading a firearm with a protruding firing pin may cause an unintentional discharge resulting in personal injury and/or death.

8. Hold the magazine separate and apart from the pistol.
9. Place your thumb on the top cartridge and slide it forward and out of the magazine. See Figure 11.
10. Repeat step 9 until the magazine is completely empty.



Figure 11

CHECKING THE BARREL FOR OBSTRUCTIONS

WARNING! NEVER try to clear or remove a barrel obstruction by loading another cartridge and discharging the firearm. This may cause property damage, personal injury, and/or death.

1. Always keep the firearm pointed in a safe direction. See *The Ten Commandments of Firearm Safety* section of this manual.
2. Remove the magazine by pressing the Magazine Release button. See Figure 7.
3. Firmly hold the firearm with your shooting hand, while keeping the Trigger clear of contact with fingers and/or other objects.
4. Pull and hold the Slide fully rearward with your support hand. If a cartridge was in the chamber, it should be ejected at this time. See Figure 8.
5. With the Slide fully rearward, lock the Slide in the open position by pushing the Slide Stop up, fully engaging the slide stop notch. See Figure 9.
6. Look into the ejection port and visually check the chamber and magazine well to make sure the handgun is completely unloaded.
7. If the firearm is not unloaded, See the "Clearing/Unloading the Firearm" section of this manual.
8. Only after the firearm is unloaded, insert an appropriately-sized cleaning rod into the muzzle.
9. Push the rod completely through the Barrel until the rod can be seen at the ejection port.

Removing Obstructions from the Barrel:

10. Insert the cleaning rod into the muzzle and lightly tap the rod to free the object from the Barrel.
11. Push the rod all the way through the Barrel until the rod can be seen at the chamber opening.
12. If an object cannot be easily pushed out of the Barrel with a cleaning rod, have the firearm serviced by a Remington Authorized Repair Center. See "How to Obtain Parts and Service from Remington" section in this manual.

WARNING! Before loading the firearm, make sure the inside of the Barrel is free of dirt, oil, or other obstructions. Discharging the firearm with a dirty and/or obstructed barrel may cause property damage, personal injury, and/or death.

LOADING THE FIREARM

WARNING! Never assume a firearm is unloaded. Never carelessly handle a firearm. Always control the direction of the muzzle of a firearm, even if you think it is completely unloaded. Careless handling of any firearm can lead to property damage, personal injury, and/or death.

AMMUNITION

WARNING! Only use ammunition designated on the Barrel. Using ammunition not designated on the Barrel including "Plus-P" (+P) or a "Plus-P-Plus" (+P+) of the same caliber, may cause property damage, personal injury, and/or death.

WARNING! Ammunition contains chemicals known in the State of California to cause cancer and birth defects or other reproductive harm.

WARNING! Do not apply oil, grease or any lubricants to cartridges. Applying lubricants to cartridges may interfere with proper operation of the cartridge, resulting in property damage, personal injury, and/or death.



There are many different types of handgun ammunition available for your new Remington pistol. Remington designs firearms to function with most commercially available ammunition. Using different combinations of bullet weights, bullet types, and propellant types will result in a variation of bullet velocities, accuracy, and felt recoil, even in pistols of the same model. Your Remington handgun was designed and tested to use only ammunition of the caliber for which it is chambered. Remington recommends that only ammunition be used in your new pistol that meets the guidelines set forth by the Sporting Arms and Ammunition Manufacturers' Institute, SAAMI. Remington highly recommends the usage of Remington or Barnes branded ammunition products. Remington does not cover warranty problems when using reloaded or remanufactured ammunition. For additional warranty information refer to page 34 or www.remingtonhandguns.com/warranty. Remington recommends consumers practice with their preferred brand of ammunition in their new pistol to ensure functionality and performance.

LOADING THE CHAMBER AND MAGAZINE

WARNING! Safe Firearms Handling dictates that live ammunition should only be loaded into your firearm when you are ready to discharge the firearm. See *The Ten Commandments of Firearm Safety* section of this manual. Loading live ammunition into your firearm when you do not wish to discharge it could result in property damage, personal injury, and/or death.

NOTE: The bore should be cleaned before loading the firearm the first time. Follow the cleaning instructions shown in the "Cleaning the Barrel" section of this manual.

1. Always keep the firearm pointed in a safe direction.

2. Verify the firearm is completely unloaded. See the "Clearing/Unloading the Firearm" section of this manual.
3. Firmly hold the firearm with your shooting hand, while keeping the Trigger clear of contact with fingers and/or other objects.
4. Pull and hold the Slide fully rearward with your support hand. If a cartridge was in the chamber, it should be ejected at this time. See Figure 8.
5. With the Slide fully rearward, lock the Slide in the open position by pushing the Slide Stop up, fully engaging the slide stop notch. See Figure 9.

Loading the Magazine:

WARNING! Always check the cartridge for the correct caliber designation before loading the firearm. Use of an incorrect caliber cartridge could result in property damage, personal injury, and/or death.

WARNING! The use of improperly loaded ammunition can lead to barrel obstructions, excessive pressure, and/or inadvertent discharge of a firearm; these could each result in property damage, personal injury, and/or death. Use only quality factory ammunition loaded to SAAMI guidelines suitable for your firearm. Examine each cartridge, particularly around the primer. Look for dents, scratches, and other signs of damage. Do not use damaged ammunition! Use of damaged ammunition could result in property damage, personal injury, and/or death.

6. Push a cartridge of the correct type and caliber, one at a time, into the magazine, sliding the cartridge under the magazine feed lips until the cartridge head is against the rear wall of the magazine. Repeat this procedure for the number of cartridges you wish to load, up to the maximum capacity. See Figure 12.
7. With the bullet end of the cartridge aligned toward the chamber, push the full magazine into the magazine well of the firearm until the magazine latch is fully engaged.
8. Ensure the magazine is fully latched by pulling downward on the magazine. It should remain in the fully latched position.



Figure 12

WARNING! Do not use excessive upward force when inserting a loaded magazine into the magazine well. Excessive upward force could cause an open slide to move forward, chambering a cartridge. An unintentional or uncontrolled discharge of your firearm may cause property damage, personal injury, and/or death.

Loading the Chamber:

9. Firmly hold the firearm with your shooting hand, while keeping the Trigger clear of contact with fingers and/or other objects.
10. Pull the slide fully rearward with your support hand. See Figure 13.

Caution! Before releasing the Slide make sure fingers, hands, and clothing are clear of the slide as it moves forward. Failure to keep your fingers, hands, and clothing clear of the Slide's forward movement can cause property damage and/or personal injury.

11. Once the slide is in the full rear position, and the muzzle is pointed in a safe direction, release the slide, letting the slide move freely forward.



Figure 13

WARNING! The firearm is now fully loaded. Pulling or depressing the Trigger will discharge the firearm. An unintentional discharge of a firearm may cause property damage, personal injury, and/or death.

DISCHARGING THE FIREARM

Caution! Always wear eye and hearing protection when discharging any firearm. Failure to do so could result in personal injury. See *The Ten Commandments of Firearm Safety* section of this manual.

WARNING! The inside of the Barrel must be clean and free of any obstructions. Discharging the firearm with a dirty and/or obstructed Barrel may cause property damage, personal injury, and/or death. See *The Ten Commandments of Firearm Safety* section of this manual. If there is an obstruction, see the "Removing Obstructions from the Barrel" section of this manual.

Caution! Keep your body, face, and hands clear of the Slide's reciprocating movement and the ejection port. Failure to keep your body, face, and hands clear of the Slide's reciprocating movement and the ejection port can lead to property damage and personal injury.

1. Always keep the firearm pointed in a safe direction.
2. To ensure proper control due to recoil while firing, grip the handgun firmly with both shooting hand and support hand. See Figure 14.
3. Point the muzzle at the intended target and pull the trigger. The firearm will discharge each time the trigger is pulled until the magazine and chamber are empty.
4. After the last cartridge is discharged, the slide stop will engage the slide, holding it in the open position.
5. Look into the ejection port and visually check the chamber and magazine well to make sure the handgun is completely unloaded.
6. Ensure the firing pin is not protruding the breech face. See: "Clearing /Unloading the Firearm" section in this manual.



Figure 14

WARNING! If a cartridge does not discharge when the trigger is pulled (misfire), keep the firearm pointed in a safe direction and wait one (1) minute before opening the action. See the "Clearing/Unloading Your Firearm" section of this manual. Failure to wait could result in a delayed and/or uncontrolled discharge of the cartridge, possibly causing property damage, personal injury, and/or death.

WARNING! If the "report" of a discharged cartridge is noticeably softer or louder or in any way irregular, stop shooting. Keep the firearm pointed in a safe direction, and carefully unload the firearm. Check the bore for obstructions. See "Checking the Barrel for Obstructions" section of this manual. Discharging a firearm with an obstruction can cause property damage, personal injury, and/or death.

WARNING! If the recoil of the firearm is harder or softer or any way irregular, stop shooting. Keep the firearm pointed in a safe direction; unload the firearm. Check the bore for obstructions. See the "Checking the Barrel for Obstructions" section of this manual. Discharging a firearm with an obstruction can cause property damage, personal injury, and/or death.

CLEANING, LUBRICATION, AND MAINTENANCE

WARNING! Before cleaning or disassembling your firearm, make sure it is completely unloaded (both the chamber and the magazine). See the "Clearing/Unloading Your Firearm" section of this manual. Cleaning, lubricating, and performing maintenance on a loaded firearm may cause property damage, personal injury, and/or death.

WARNING! After each use, follow the lubrication and maintenance directions in this Owner's Manual. If the firearm is immersed in water, it must be thoroughly dried, cleaned, and lubricated as soon as possible. In case of saltwater immersion, first flush all parts with fresh water, then dry, clean, and lubricate the firearm. If the firearm does not function properly, have it checked and corrected by a Remington Authorized Repair Center before further use. Failure to follow these instructions may lead to firearm malfunctions which could result in property damage, serious personal injuries, and/or death.

LUBRICATION

WARNING! The use of non-recommended lubricants or cleaners could adversely affect the function and safe operation of your firearm. Do not use congealing lubricants. The use of non-congealing lubricants such as Rem Oil is strongly recommended. The use of improper lubricants may interfere with the safe operation of your firearm, resulting in property damage, personal injury, and/or death.

For safe and dependable operation of your handgun, the barrel and action must be periodically cleaned and lubricated. When a firearm is to be stored, it should be thoroughly cleaned and oiled. Outside metal surfaces should be wiped occasionally with Rem Oil. When the firearm is to be reused, all excess lubrication must be removed.

DISASSEMBLING THE FIREARM FOR CLEANING

WARNING! Before cleaning or disassembling your firearm, make sure it is completely unloaded (both the chamber and the magazine). See the "Clearing/Unloading the Firearm" section of this manual. Always wear eye protection when handling, disassembling and reassembling the firearm. Failure to follow these instructions may cause property damage, personal injury, and/or death.

Caution! Use extreme care when removing the Guide Rod Springs, Magazine Spring and the Firing Pin Spring, as they are under compression. Wear eye protection to avoid personal injury. Failure to follow these instructions may cause property damage and/or personal injury.

Caution! The Model RM series of handguns should not be disassembled beyond what is described in this manual, except by a Remington Authorized Repair Center.

Removing and Disassembling the Slide:

1. Always keep the firearm pointed in a safe direction.
2. Verify the firearm is completely unloaded. See the "Clearing/Unloading the Firearm" section of this manual.
3. Push the Slide rearward, aligning the Unlock Pin with the disassembly hole in the Slide. See Figure 15.
4. With the Slide's disassembly hole aligned with the Unlock Pin, push the Unlock Pin with a punch from the shooter's right side of the slide. See Picture 16.



Figure 15



Figure 16

5. Release the Slide, allowing the Slide to move freely forward.
6. Remove the Slide from the Frame Assembly by firmly pulling the Slide forward. See Figure 17.



Figure 17



Figure 18

7. While lifting the rear of the Guide Rod Assembly up from the Barrel, pull the assembly rearward from the slide. See Figure 18.
8. Lift the Barrel up and rearward from the slide. See Figure 19.



Figure 19

Removing the Firing Pin Assembly:

Caution! Use extreme care when removing the Firing Pin Assembly, as it is under compression. Keep the Firing Pin Assembly pointed away from you and in a safe direction during all steps of the disassembly process. Wear eye protection to avoid personal injury. Failure to follow these instructions may cause property damage and/or personal injury.

9. Remove the Firing Pin (FP) Assembly from the rear of the Slide by first pushing the Firing Pin Assembly inward with a punch while slowly sliding the Firing Pin Retainer downward until it is clear of the Slide. See Figure 20.
10. Remove the Firing Pin Assembly from the Slide by pulling it rearward. See Figure 21.

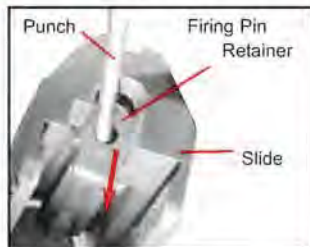

Figure 20

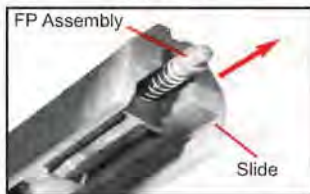

Figure 21

NOTE: Remington does not recommend disassembly the firearm beyond what is described in this manual.

Disassembling the Magazine:

WARNING! Unload the magazine before cleaning and/or servicing. See the "Clearing/Unloading Your Firearm" section of this manual. Always wear eye protection when handling, disassembling and reassembling the magazine. Cleaning and/or servicing a firearm and/or it's components while it is loaded may cause property damage, personal injury, and/or death.

Caution! Use extreme care when removing the Magazine Spring, as it is under compression. Keep the bottom of the magazine body pointed away from you and in a safe direction during all steps of the magazine disassembly process. Wear eye protection to avoid personal injury. Failure to follow these instructions may cause property damage and/or personal injury.

1. Always keep the firearm pointed in a safe direction.
2. Remove the magazine by pressing the Magazine Release button.
3. Verify the Magazine is completely unloaded. See the "Clearing/Unloading the Firearm" section of this manual.

4. To control the spring during disassembly, insert a punch into one of the Magazine Body's viewing holes. See Figure 22.

5. Using a rigid tool, push the Magazine Butt Plate Retainer tab in while partially sliding the Magazine Butt Plate toward the front of the Magazine Body. See Figure 22 and 23.

6. Place a finger over the Magazine Butt Plate Retainer to prevent the internal components from being expelled outward.

7. Carefully finish sliding the Magazine Butt Plate from the Magazine Body. See Figure 23.

8. While removing the punch, slowly allow the Magazine Spring to expand outward until all the spring load is relieved.

9. Remove the Magazine's Butt Plate Retainer, Spring, and the Follower from the bottom of the Magazine Body. See Figure 24.



Figure 22



Figure 23

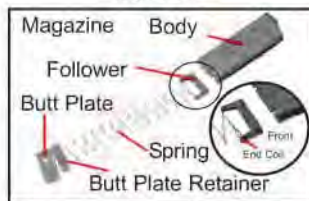

Figure 24

Cleaning / Reassembling the Magazine:

WARNING! *Unload the firearm before cleaning and/or servicing. See the "Clearing/Unloading Your Firearm," section of this manual. Always wear eye protection when handling, disassembling and reassembling the firearm. Cleaning and/or servicing a firearm and/or its components while it is loaded may cause property damage, personal injury, and/or death.*

Caution! *Keep the bottom of the Magazine Body pointed away from you and in a safe direction during all steps of the magazine disassembly process. Failure to follow these instructions may cause property damage and/or personal injury.*

1. Disassemble the magazine by following the instructions in the "Disassembling the Magazine" section of this manual.
2. Spray all magazine components with Rem Action Cleaner.
3. If necessary, use a brush to remove any fouling residue.
4. Wipe the magazine components with a clean patch. Allow to air dry.
5. Apply a light coating of Rem Oil to Magazine Body, Magazine Spring, Magazine Butt Plate and Magazine Butt Plate Retainer.
6. Insert the Magazine Follower, Magazine Spring and the Magazine Butt Plate Retainer into the bottom of the Magazine Body. Orient the spring with the end-coil to the front of the magazine. See the insert in Figure 24. Orient the Magazine Butt Plate Retainer with the tab facing out.

7. Push on the Magazine Butt Plate Retainer, compressing the Magazine Spring and the Magazine Butt Plate Retainer below the bottom of the Magazine Body.

8. To aide in the assembly, insert a punch into one of the Magazine Body's viewing holes. See Figure 25.

9. Slide the Magazine Butt Plate on the bottom of the Magazine Body until the Magazine Butt Plate Retainer tab snaps into the hole on the Magazine Butt Plate. See Figure 25 and 22.

10. Slowly remove the punch from the Magazine body.

11. Once the punch is removed, push the follower, ensuring the follower moves freely and without hesitation. If the Follower does not move freely, disassemble, clean and reassemble.

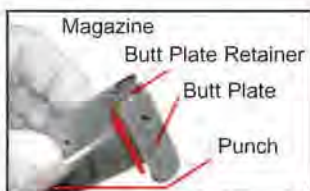

Figure 25

CLEANING THE BARREL

WARNING! *Unload the firearm before cleaning and/or servicing. See the "Clearing/Unloading Your Firearm" section of this manual. Always wear eye protection when handling, disassembling and reassembling the firearm. Failure to follow these instructions may cause property damage, personal injury, and/or death.*

1. Always keep the firearm pointed in a safe direction.
2. Verify the firearm is completely unloaded. See the "Clearing/Unloading the Firearm" section of this manual.

NOTE: Follow the instructions and use the equipment provided in a quality cleaning kit such as a Remington Cleaning Kit. For recommendations, see your dealer or a Remington Authorized Repair Center.

3. Remove the Barrel from the pistol. See the "Removing and Disassembling the Slide" section of this manual.
4. Attach a patch to a cleaning rod tip and saturate with a cleaning solvent product such as Remington Brite Bore cleaning solvent.
5. Pass the patch through the bore starting from the chamber end to the muzzle several times to remove loose residue and fouling.
6. Select the correct caliber bore brush and attach the brush to the cleaning rod.
7. Spray the bore brush with Remington Brite Bore cleaning solvent.
8. Push the cleaning rod through the complete length of the Barrel several times.
9. Remove the brush from the rod and attach a tip with a clean patch.
10. Push the cleaning patch through the bore.
11. Repeat several times using a new cleaning patch each time until the removed patch is free from fouling residue.
12. Push a clean patch saturated with Rem Oil through the Barrel.
13. Push a clean dry patch through the barrel to remove excess lubricant.

14. Brush the barrel feed ramp and outside surfaces to remove all fouling residue.
15. Wipe the Barrel with a clean patch and allow to air dry.
16. Apply a light coating of Rem Oil to the outside of the Barrel with a soft clean cloth.

WARNING! After cleaning, make sure the Barrel is free of obstructions, see the "Checking the Barrel for Obstructions," section of this manual. Discharging the firearm with a dirty and/or obstructed barrel may cause property damage, personal injury, and/or death.

CLEANING THE RECOIL SPRING/GUIDE ROD ASSEMBLY

WARNING! Unload the firearm before cleaning and/or servicing. See the "Clearing/Unloading Your Firearm" section of this manual. Always wear eye protection when handling, disassembling and reassembling the firearm. Failure to follow these instructions may cause property damage, personal injury, and/or death.

1. Disassemble the firearm following the instructions in the "Disassembling the Firearm for Cleaning" section of this manual.
2. Spray the Recoil Spring/Guide Rod Assembly with Rem Action Cleaner.
3. Use a brush to remove any fouling residue, if necessary.
4. Wipe the Recoil Spring/Guide Rod Assembly with a clean cloth or cleaning patch and allow to air dry.
5. Apply a light coating of Rem Oil to the Recoil Spring/Guide Rod Assembly with a soft clean cloth.

CLEANING THE FIRING PIN ASSEMBLY

1. Disassemble the firearm following the instructions in the "Disassembling the Firearm for Cleaning" section of this manual.
2. Spray the Firing Pin and the Firing Pin Springs with Rem Action Cleaner.
3. Use a brush to remove any fouling residue, if necessary.
4. Wipe the Firing Pin and the Firing Pin Springs with a clean cloth or cleaning path and allow to air dry.
5. Apply a light coating of Rem Oil to the Firing Pin and the Firing Pin Springs with a soft clean cloth.

CLEANING THE SLIDE ASSEMBLY

WARNING! Unload the firearm before cleaning and/or servicing. See the "Clearing/Unloading Your Firearm," section of this manual. Always wear eye protection when handling, disassembling and reassembling the firearm. Failure to follow these instructions may cause property damage, personal injury, and/or death.

1. Disassemble the firearm following the instructions in the "Disassembling the Firearm for Cleaning" section of this manual.
2. Spray the Slide with Rem Action Cleaner, including the breech face, barrel channel, rail cuts, and the firing pin hole. See Figure 26.

3. Use a nylon brush to remove any fouling residue, if necessary.
4. Wipe the Slide with a clean patch or cloth and allow to air dry.
5. Spray the inside of the Slide with Rem Oil. Ensure the rail cuts and barrel channel are well lubricated.
6. Apply a light coating of Rem Oil to the outside of the Slide with a soft clean cloth.

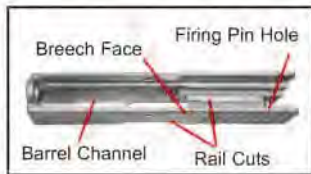

Figure 26

CLEANING THE FRAME ASSEMBLY

WARNING! Unload the firearm before cleaning and/or servicing. See the "Clearing/Unloading Your Firearm," section of this manual. Always wear eye protection when handling, disassembling and reassembling the firearm. Failure to follow these instructions may cause property damage, personal injury, and/or death.

1. Disassemble the firearm following the instructions in the "Disassembling the Firearm for Cleaning" section of this manual.
2. Spray the Frame Assembly with Rem Action Cleaner.
3. If necessary, use a brush to remove any fouling residue.
4. Wipe the Frame Assembly with a clean cloth or cleaning patch and allow to air dry.
5. Apply a light coating of oil to the inside of the Frame Assembly. Include between the Sear Trigger Bar and Grip, the Magazine Latch and the Slide Rails. See Figure 27.
6. Rotate the Hammer rearward and liberally lubricate the Hammer Spring Pocket / Plunger and Linkage.



Figure 27

REASSEMBLING THE FIREARM

WARNING! The firearm's owner and user must accept full responsibility for the correct reassembly and functioning of the firearm after the disassembly or the replacement of parts. Incorrectly assembling the firearm or the use of modified or incorrect parts can result in property damage, personal injury, and/or death.

NOTE: Remington recommends all service and replacement of components be performed by a Remington Authorized Repair Center. If a repair or component replacement was not completed by a Remington Authorized Repair Center, we recommend that you have your firearm checked by an Authorized Repair Center to verify your firearm is operating properly and safely.

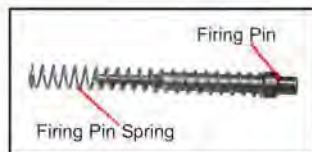

Figure 28



Figure 29

Caution! Always wear eye protection when handling, disassembling and reassembling the firearm. Failure to follow these instructions may cause property damage and/or personal injury.

1. Place the Firing Pin Spring onto the Firing Pin. See Figure 28.
2. Insert the Firing Pin Assembly into the rear of the slide. See Figure 29.
3. Insert the Firing Pin Retainer into its retaining slots in the slide. See Figure 30.
4. Push the Firing Pin Assembly in the Slide while sliding the Firing Pin Retainer over the Firing Pin Assembly until the Firing Pin is captured by the Firing Pin Retainer. See Figure 31.
5. Insert the Barrel into the Slide. See Figure 32.
6. Once the Barrel is inserted into the Slide, move it rearward until it seats next to the Breech Face.
7. Insert the Inner Guide Rod Spring onto the Guide Rod.
8. Insert the Outer Guide Rod Spring over the Inner Guide Rod Spring. See Figure 33.
9. Insert the front of the Recoil Spring/ Guide Rod Assembly into the Slide and through the Guide Rod hole. See Figure 34.
10. Compress the Recoil Springs slightly, center and seat on top of the Guide Rod lip and against the Barrel Block. See Figure 35 and 36.
11. Push the Slide Assembly onto the Frame. See Figure 37.

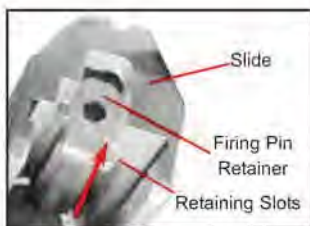

Figure 30



Figure 31



Figure 32

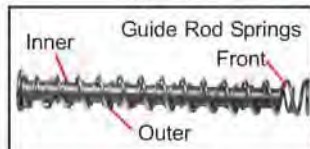

Figure 33



Figure 34



Figure 35

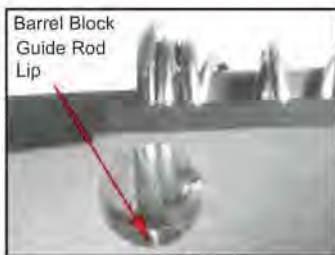

Figure 36



Figure 38



Figure 37

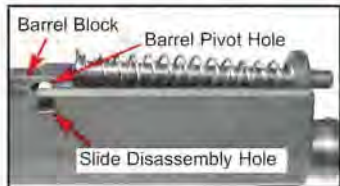

Figure 39

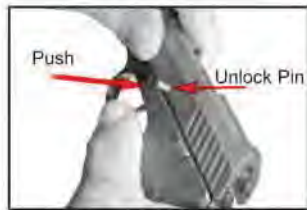

Figure 40

12. Push the Slide rearward, aligning the Unlock Pin Hole in the frame with the disassembly hole in the Slide. See Figure 38.
13. Align the Slide's disassembly hole with the barrel's pivot hole. Reference Figure 39.
14. With the Slide's disassembly hole aligned with the Barrel's pivot hole, push the Unlock Pin into the Slide's disassembly hole from the shooter's left side of the slide. See Figure 40.
15. Push the Unlock Pin completely through the Slide until it stops.
16. Lock the Slide in the open position by moving the Slide fully rearward, then push the Slide Stop up, fully engaging the Slide Stop notch. See Figure 9.

FUNCTION TESTING THE FIREARM

WARNING! If the firearm experiences a malfunction during the Function Test, the firearm is not safe to use. This firearm should be serviced by a Remington authorized repair center. See the "How to Obtain Parts and Service From Remington" section of this manual to have your firearm repaired. Use of a firearm which fails the Function Test may cause property damage, personal injury, and/or death.

When the firearm is reassembled, a short function test should be conducted to ensure proper operation before loading or discharging the firearm. If the firearm does not function as described in any of the Function Testing, the firearm is NOT in a safe operating condition and it must NOT be used until you have it inspected by a Remington Authorized Repair Center or call the consumer service number, 1-800-243-9700, Mon.-Fri., 9:00 AM-5:00 PM Eastern Standard Time.

WARNING! Unload the firearm before function testing. See the "Clearing/Unloading Your Firearm" section of this manual. Always wear eye protection when handling, disassembling and reassembling the firearm. Failure to follow these instructions may cause property damage, personal injury, and/or death.

1. Always keep the firearm pointed in a safe direction. See *The Ten Commandments of Firearm Safety* section of this manual.
2. Verify the firearm is completely unloaded and free of any obstructions. See the "Clearing/Unloading the Firearm" section in this manual.
3. While holding the firearm with your shooting hand, and keeping the Trigger clear of contact with fingers and/or other objects, pull the Slide fully rearward and release. The Hammer should NOT remain in the rearward position.
4. Pull the Trigger and ensure the Trigger and Hammer have full double action motion and the hammer releases and falls fully forward without hesitation.
5. Ensure the firing pin is not protruding the breech face and it moves freely without hesitation. See the "Clearing/Unloading the Firearm" section in this manual.
6. Ensure the barrel is free of obstructions. See the "Checking the Barrel for Obstructions" section in this manual.
7. With the Slide forward, insert an empty magazine into the magazine well of the frame.
8. While holding the firearm with your shooting hand, pull the Slide fully rearward and release. The slide should not move forward.
9. Remove the magazine by pushing the Magazine Release button. See Figure 7.
10. Insert an empty magazine into the magazine well with moderate force. The slide should remain in the rearward position.
11. Ensure the magazine remains fully latched by pulling it downward. The magazine should remain latched in the magazine well.
12. Remove the magazine by pushing the Magazine Release button. See Figure 7.
13. Release the Slide Stop by moving the Slide rearward then releasing. The Slide should release and move fully forward.
14. Ensure both Grips Mounting Screws are torqued with 5 to 8 in-lb of torque. Do not over tighten.
15. If the firearm does not function as described in any of the Function Testing, the firearm is NOT in a safe operating condition and it must NOT be used until you have it inspected by a Remington Authorized Repair Center or call the consumer service number, 1-800-243-9700, Mon.-Fri., 9:00 AM-5:00 PM Eastern Standard Time.

WARNING! The firearm owner and user must accept full responsibility for the correct reassembly and functioning of the firearm after the disassembly or the replacement of parts. Incorrectly assembling the firearm or the use of modified or incorrect parts can result in property damage, personal injury, and/or death.

TO REPLACE THE FIREARM GRIPS

WARNING! Unload the firearm before cleaning and/or servicing. See the "Clearing/Unloading Your Firearm" section of this manual. Always wear eye protection when handling, disassembling and reassembling the firearm. Failure to follow these instructions may cause property damage, personal injury, and/or death.

1. Always keep the firearm pointed in a safe direction. See *The Ten Commandments of Firearm Safety* section of this manual.
2. Verify the firearm is completely unloaded and free of any obstructions. See the "Clearing/Unloading the Firearm" section of this manual.
3. Remove the magazine by pressing the Magazine Release button. See Figure 7.
4. With the Slide fully rearward, lock the Slide in the open position by pushing the Slide Stop up, fully engaging the Slide Stop notch. See Figure 9.
5. Lay the pistol flat on the shooter's right side on a work bench.
6. With a T-7 Torx Wrench, unscrew (counterclockwise) the mounting screws.
7. Remove the left grip by moving it down slightly to clear the Slide Stop then lift it from the frame. Do not disturb the components under the grip. See Figure 41.
8. Attach the grip by first sliding the grip under the slide stop.
9. Align the mounting holes in grip to corresponding holes in the frame.
10. Secure the Grip to the frame by inserting then tightening (clockwise) the Mounting Screws. Tighten the Mounting Screws to a torque of 5 to 8 in-lb. Do not over tighten.
11. Lay the pistol flat on the shooter's left side on a work bench.
12. With a T-7 Torx Wrench, unscrew (counterclockwise) the Mounting Screws.
13. Remove the Right Grip by lifting it from the frame. Be careful not to disturb the components under the grip once the grip is removed.
14. If the linkage is disturbed and it is required to reassemble, place the Trigger and the Trigger Pin as shown in Figure 42.
15. Move the Trigger fully forward while attaching the Sear Trigger Bar to the Trigger Link Pin.
16. Lay the left end of the Sear Trigger Bar under the Hammer Retaining Boss. See Figure 42.
17. Insert the Sear Trigger Bar Spring to the Sear Trigger Bar then to the frame. See Figure 42.
18. Attach the Grip by aligning its mounting holes to the corresponding holes in the frame.



Figure 41

19. Secure the Grip to the frame by inserting then tightening (clockwise) the Mounting Screws. Tighten the Mounting Screws to a torque of 5 to 8 in-lb. Do not over tighten.
20. Once the grips are mounted securely, verify the firearm functions properly. See the "Function Testing the Firearm" section in this manual.

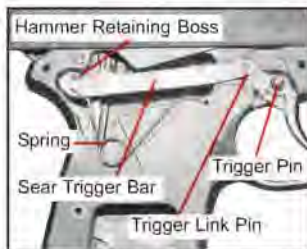

Figure 42

Firearm Sale or Transfer:

If your firearm has been adjusted or changed in any way and you intend to sell or otherwise transfer possession of your pistol, you must: 1) provide a complete service record, (2) warn the purchaser or recipient of your firearm that it has been adjusted or modified, and (3) give the purchaser or recipient this owner's manual for review and reference. If you do not wish to sell or transfer your pistol in an adjusted condition (recommended), return it to a Remington Authorized Repair Center for restoration of your pistol to the original factory conditions. Do Not attempt to restore the pistol to factory conditions yourself.

WARNING! NEVER alter or modify any part of the firearm. Improper alterations can make the pistol unsafe and result in property damage, personal injury and/or death.

This firearm should not be sold where prohibited by federal, state or local laws.

All rights to this instruction manual are reserved. The information in this document is subject to change without notice. Remington reserves the right to change the content herein without the obligation to notify any person or organization of such changes.

Remington is a registered trademark of Remington Arms Company, LLC. and may not be used in any way without the express written consent of Remington. All other trademarks used herein remain the exclusive property of their respective owners. Nothing contained in this manual should be construed as granting, by implication or otherwise, any license to trademarks displayed herein. Misuse of any trademarks or any content of this manual is strictly prohibited. Remington shall aggressively enforce its intellectual property rights to the fullest extent of the law.

Model RM Series Semiautomatic Pistol

Exploded View

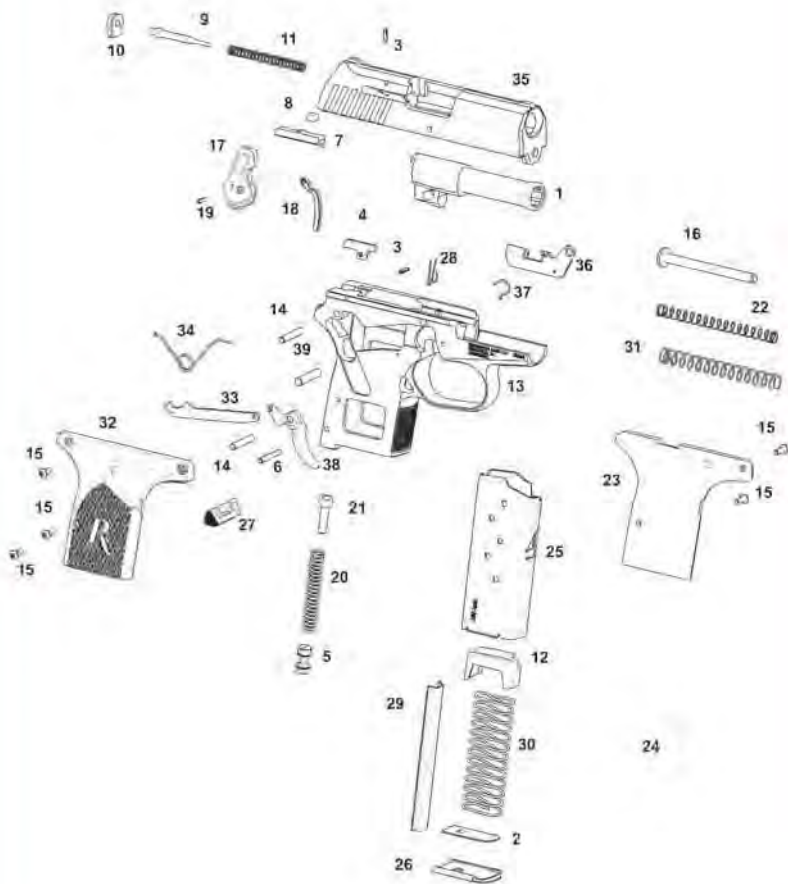

Schematic is provided for part identification only and should not be used as a guide to assemble the firearm.

MODEL RM Series Semiautomatic Pistol

Parts List

ITEM	PART NAME	ITEM	PART NAME
1	Barrel	21	Hammer Spring Detent
2	Butt Plate Catch	22	Inner Recoil Spring
3	Coil Pin (2)	23	Left Grip
4	Ejector	24	Magazine Assembly
5	End Plug	25	Magazine Body
6	End Plug Pin	26	Magazine Butt Plate
7	Extractor	27	Magazine Release
8	Extractor Button	28	Magazine Release Spring
9	Firing Pin	29	Magazine Spacer
10	Firing Pin Retainer	30	Magazine Spring
11	Firing Pin Spring	31	Outer Recoil Spring
12	Follower	32	Right Grip
13	Frame	33	Sear Trigger Bar
14	Frame Pin (2)	34	Sear Trigger Bar Spring
15	Grip Screw (5)	35	Slide
16	Guide Rod	36	Slide Stop Lever
17	Hammer	37	Slide Stop Spring
18	Hammer Link	38	Trigger
19	Hammer Link Pin	39	Unlock Pin
20	Hammer Spring		

NOTE: Remington recommends all service and replacement of components be performed by a Remington Authorized Repair Center. If a repair or component replacement was not completed by a Remington Authorized Repair Center, we recommend that you have your firearm checked by an Authorized Repair Center to verify your firearm is operating properly and safely.

HOW TO OBTAIN PARTS AND SERVICE FROM REMINGTON

To Order Parts:

To order parts please visit Remington's website @ www.remington.com or call 1-800-243-9700. For additional information on service enhancements, upgrades, repair, additional barrels, and specialty parts visit www.remington.com.

To place an order or for additional information on service enhancements, upgrades, and additional barrels, please call our toll free consumer service number, 1-800-243-9700, Mon.-Fri., 9:00 AM-5:00 PM Eastern Standard Time.

1. Fax completed order form (from the catalog) to 1-336-548-7711.
2. To order by phone without the order form call 1-800-243-9700.

Please have the following information ready before you call.

- Firearm model and serial number.
- Part description and quantity. Part descriptions can be found on the parts listing on page 32 in this manual.
- Your complete mailing address (P.O. Box and Street Address) including zip code, telephone number and e-mail address.
- Method of payment: MasterCard, Visa, Amex or Discover card number and expiration date. A quote may be made to you over the phone. (Sorry, no C.O.D.s.)

WARNING! Use only Remington parts in Remington firearms.

NOTE: Some parts may be restricted. See parts list for details. Owner's Manuals / instruction books may be requested via our web site at: www.remington.com or by calling 1-800-243-9700.

Repair Services:

If there is a defect with your Remington firearm that (i) you believe is, or should be, covered by the Warranty, (ii) you would like Remington to address at your cost and expense, or (iii) you would otherwise like to discuss with Remington, please contact Remington Consumer Services at 1-800-243-9700, Mon.-Fri., 9:00 AM-5:00 PM Eastern Standard Time. Please do not send your firearm or other item to Remington without first (a) calling this number, (b) receiving instructions from the Remington representative, and (c) obtaining a Service Request document containing your Service Repair Number (SRN). With regards to the Service Request document, Remington will either e-mail this document to you or, if you do not have an e-mail address, Remington will mail it to you. Please be sure to store your Service Request document in your records so that it is both safe and accessible. Finally, to the extent you seek Warranty coverage, please review the Warranty for your Remington firearm and note that you may void your Warranty by taking action without first contacting Remington.

To review the Warranty and to register, please visit our website at: www.remingtonhandguns.com/warranty

If shipment of your firearm is required, a SRN must be obtained prior to shipment and please follow the instructions below:

- Record the serial number of your firearm before shipping.
- Ensure your firearm is unloaded. To unload your firearm, see the "Clearing/Unloading the Firearm" section of this manual.
- Pack your firearm for safety and to prevent further damage in shipping and handling. Preferably, ship in a firearm box.
- Remove all accessories from the firearm to prevent loss or damage.
- Enclose the filled out return form along with your firearm. The return form can be found at www.remington.com or call Remington at 1-800-243-9700 to request a copy of the form. Be sure to include your full name and address (P.O. Box and Street Address), including zip code, daytime telephone number and e-mail address.
- Place your SRN on the shipping label.
- Check your government guidelines before shipping.
- Remington is not responsible for damage or loss during shipment. You may elect to purchase insurance from your carrier.

WARNING! Do not send live or spent ammunition in your firearm or in the same box with the firearm. This is a violation of Federal Law. If you feel you must send spent ammunition, please send them in a separate package and include your name, address (with zip code), telephone number, model and serial number of your firearm.

Firearm Owner's Record

Model: _____

Serial No. _____

Date Purchased: _____

Purchased From: _____

Price Paid: _____

This instruction manual should always accompany this firearm and be transferred with it upon change of ownership.

FIREARMS WARRANTY and REGISTRATION

If you seek Warranty coverage, please review the Warranty for your Remington firearm and note you may void your Warranty by taking action without first contacting Remington. For instruction to obtain Warranty coverage, see "Repair Services" on page 34.

Please take a moment right now to register ONLINE to obtain the full benefit of your Limited Two Year Firearm Warranty.

To review the Warranty and to register, please visit our website at: www.remingtonhandguns.com/warranty

Do NOT alter or modify your RM Pistol, and have it serviced regularly.

Your firearm has been designed to operate according to certain factory specifications. You'll jeopardize your safety and that of others around you by attempting to alter its trigger, mechanical safety or other mechanisms. Never alter or modify your firearm in any way.

Like any mechanical device, a firearm is subject to wear. It must be maintained and periodically serviced to ensure optimum safety and performance. Only a qualified service facility should service, repair, or modify your Remington firearm. Consult our website www.remington.com for the location of the nearest Authorized Remington Repair Center.

Remington recommends that you have your firearm professionally serviced annually. You should also have your firearm professionally serviced after prolonged storage, or if there is ever any question pertaining to the proper functioning characteristics of your firearm.

Proper cleaning and lubrication are also important to firearm maintenance and are necessary to ensure accuracy, safety, and reliability. Before cleaning, always make sure that your firearm is completely unloaded. And always clean the barrel from the chamber end to the muzzle when possible.

MODEL RM Series
Semiautomatic Pistols

Remington®

Remington is a Trademark Registered in the United States Patent and
Trademark Office By Remington Arms Company, LLC.