

AREX *Delta*

OPERATOR'S MANUAL

gen.2 9 mm



AREX



SAFETY RULES

Please read this operator's manual carefully before handling your firearm. The following general firearms safety rules have been included in this manual by Arex d.o.o. as an important reminder that firearm safety is your responsibility. If mishandled, firearms can be dangerous and can be used to cause serious injury, damage to property and death.



WARNING: All firearms are loaded at all times. Even when a firearm is not loaded, treat it as if it was!

1. Never point a firearm at anyone or anything you are not willing to destroy. Be aware of the muzzle direction at all times. A **SAFE DIRECTION** means that the firearm is so pointed that it would not cause injury or unwanted damage, even if it would discharge.
2. Keep your **FINGER OFF THE TRIGGER** and outside of the trigger guard (see Figure 18) unless actually applying pressure to it (always keep your finger outside of the trigger guard while handling the firearm without intention to shoot, while loading or unloading the firearm, while pulling the firearm out of the holster or returning it to the holster).
3. When picking up or receiving a firearm always **CHECK WHETHER IT IS LOADED** or not (see Clearing, Pg. 15). Never give a firearm to or take it from anyone unless the action is open and the magazine and chamber are free of ammunition.
4. Be positive of the **TARGET AND BACKSTOP** beyond. Know that a fired bullet can penetrate the intended target as well as obstacles such as ceilings, floors, walls, doors and windows and it can ricochet off almost anything it strikes.
5. Be sure that you are using **CORRECT AMMUNITION** for the specific firearm, verify that it is factory loaded and that it is not damaged in any way (see Ammunition, Pg. 18).
6. Before firing, make sure the chamber is clear of any ammunition or empty cases and **CHECK THE BARREL** of the unloaded firearm (see Malfunction procedures, Pg. 25) for any possible obstructions.
7. Before firing any firearm, make sure that you **UNDERSTAND HOW TO OPERATE** it correctly (see Instructions for use, Pg. 15). Lack of familiarity with the firearm can result in serious accidents. Attend a certified training course with any firearm you intend to use or with which you are not sufficiently familiar.
8. Always **WEAR HEARING AND EYE PROTECTION** when using a firearm. Hearing damage is accumulative and irreversible, severe hearing loss can result from even a single heard gunshot. A spent casing ejected at high speed from self-loading firearm, burning propellant particles and parts of bullet ricocheting backwards can cause serious injury or permanent blindness.
9. Keep all body parts, especially the hands and fingers, away from the muzzle to avoid injury or burns. Be sure that no part of either hand touches or interferes with the slide during firing. The slide moves backward with considerable speed and may cause serious injury.
10. Avoid the use of any alcoholic beverages or drugs before or during your use of a firearm.
11. You should lock and store firearms separately from ammunition and out of the reach of children and/or any untrained/unauthorized individuals.



WARNING: Discharging firearms in poorly ventilated areas, cleaning firearms, or handling ammunition may result in exposure to lead, a substance known to be associated with birth defects, reproductive harm and other serious injury. Have adequate ventilation at all times. Wash hands thoroughly after exposure.



STOP! Know how to clear this pistol before attempting to operate.

Clearing the pistol -The AREX *delta* pistol is not considered “clear” unless:

1. The magazine is removed from the pistol
2. The slide is opened and/or locked to the rear and
3. The chamber is free of ammunition or empty cases.

To clear the AREX *delta* pistol (see Clearing, Pg. 15, for detailed explanation):

1. Make sure fingers are outside of the trigger guard and the pistol is pointed in a safe direction at all times!
2. Engage manual safety (if present). Push the safety lever up (left or right) to its uppermost position.
3. Remove magazine. Depress the magazine release button (left or right) and remove the magazine from the pistol.
4. Open and lock slide. While pointing the pistol in a safe direction, lock the slide open by pulling the slide rearward, releasing it, pulling it back again and pressing the slide catch/release (left or right) upward at the same time. Watch for a single cartridge or empty case (i.e. “brass”) to be ejected from the pistol.
5. Inspect chamber. Inspect chamber for the presence of a cartridge or empty case either:
 - Visually - by looking into chamber through the open ejection port or
 - Physically - by inserting a finger into chamber through the open ejection portto check for the presence of a cartridge or empty case.
6. Remove any cartridges. Clear cartridges or empty cases from the chamber or from within the pistol.

The AREX *delta* pistol is now considered “Clear.”



WARNING: A discharging firearm has the capability of taking your life or the life of someone else! Be extremely careful with any firearm. An accident can occur at any time and is usually the result of ignoring basic safety rules.



WARNING: Read and understand all warnings in this operator’s manual. It is an integral component of the firearm system and should accompany the pistol in case of transfer to another user. Failure to follow any of the warnings listed herein could result in material damage, serious injury or death.

AREX *Delta*
OPERATOR'S MANUAL



AREX d.o.o. Šentjernej
Trubarjeva cesta 7, SI-8310 Šentjernej, Slovenia, EU
NCAGE: 1064Q
Phone: +386 7 393 34 50 / Fax: +386 7 393 34 51
support@arex.si
www.arex.si

Arex d.o.o has made every effort to insure the information contained in this manual is accurate at the time of publishing. However, we cannot warrant, expressly or by implication, that it contains no inaccuracies, errors or omissions.

TABLE OF CONTENTS

Safety Rules & Basic Clearing	Inside Cover
Section 1 Introduction	6
Section 2 Nomenclature	8
Section 3 Specifications	11
Section 4 Function & Operation	12
Cycle of Operation	12
Safety Features	13
Section 5 Instructions for use	15
Clearing	15
Adjusting the grip size	17
Ammunition	18
Filling the Magazine	19
Loading the pistol	20
Sights and Aiming	22
Firing	23
Unloading	24
Malfunction procedures	25
Storage & Transport	27
Selection & Use of a Holster	27
Section 6 Disassembly & Assembly	28
Disassembly	28
Magazine Disassembly	29
Disassembly of plus 2 magazines	30
Assembly	31
Magazine Assembly	33
Assembly of plus 2 magazines	34
Function Check	35
Section 7 Cleaning & Maintenance	37
Cleaning	37
Inspection	38
Lubrication	39
Troubleshooting Problems & Repair	40
Warranty Registration Information	41
Optics ready platform	42
Accessories	44
Section 8 Parts List	45
Exploded View	46
Firearms Service Record	47

INTRODUCTION

The AREX *delta* represents a new generation of modern striker-fired pistols developed by Arex to incorporate all the advantages and none of the drawbacks associated with most polymer-framed striker-fired handguns. The AREX *delta* is slender, compact and light enough to be carried concealed while still providing high capacity for serious personal protection. The AREX *delta* is the right striker-fired pistol for duty carry because of its enhanced safety features, reliability and durability. Its redundant safety systems will not allow it to fire when it is not supposed to and its advanced construction and precise manufacturing helps ensure it will fire every time you need it to. This is what you have come to expect from an AREX pistol. The AREX *delta* can conform to your hand perfectly via four interchangeable backstraps that virtually transform it to fit most hand sizes. With appropriate grip size selected, the pistol points naturally which in consequence brings the sights in your line of sight fast, every time. We have engineered front and rear grip serrations to have a proper bite in the hand but not catch on clothing if covert carry is called upon. The AREX *delta* tends to cling to the hand when it is fired, even in rapid succession. The AREX *delta* is light to carry yet comfortable to shoot even hot defensive ammunition. With a low bore axis and clever weight distribution it will enable you to shoot fast follow-up shots with precision unlikely to be found in other compact pistols. Universal interface rail is included in front of the trigger guard to enable quick and easy accessory mounting.

NOTE: Improperly designed or installed accessories may result in damage to the mounting interface and/or the pistol. Such damage is not covered under the warranty. Be certain to use only appropriate accessories and follow manufacturer's installation procedures and precautions carefully.

The AREX *delta* is a compact pistol chambered for the potent 9 mm Parabellum cartridge, operating with modified Browning's tilting barrel dynamic breech lock. The size and weight put the AREX *delta* on the smaller and lighter side of polymer compacts but its high capacity puts it in the range of full size service pistols. The AREX *delta* has a contoured narrow slide measuring in at mere 26 mm at its widest thus making it easier to carry concealed or open. The slide is milled from a solid block of high carbon steel and surface enhanced with tough and corrosion resistant nitro-carburized finish, specially designed deltoid rear as well as front slide serrations ensure a non-slip grip during slide manipulation. Deltoid slivers have been removed from the slide to achieve considerable weight reduction as well as easier holstering and no-snap presentations. We have included a properly slanted rear sight for the same reason. Both sights are also serrated to ensure perfect no-glare sight picture and rapid target acquisition. As with every AREX firearm, the heart of the AREX *delta* is its extremely durable signature in-house manufactured one-piece cold hammer-forged barrel made from chromolly steel with nitro-carburization finish applied. This combination guarantees excellent surface hardness and corrosion protection during prolonged hard use as well as high accuracy and excellent service life.

The AREX *delta* employs the unique Striker Double Action trigger system (SDA). During the charging of the firearm (closing of the slide) the striker is only partially cocked and trigger operation results initially in cocking action (Double Action) before the striker is released upon completion of the rearward trigger travel, as the trigger is pressed completely to the rear. The SDA system provides enhanced user safety as the firearm can be carried confidently with a loaded chamber and a virtual double action trigger. The SDA trigger system provides a very tactile feedback during the DA cocking stage allowing for a significant margin of error during trigger operation by enabling the operator to stop pressing the trigger at any time during that initial cocking phase. Nevertheless, unlike traditional double action triggers the SDA trigger system allows for above the average level of precision with its distinctive "wall" after the initial cocking action followed by a crisp break. Where multiple consecutive shots are

warranted, the extra short trigger reset facilitates fast follow-up with merely 2 millimeters of forward trigger travel before positively resetting for the next shot.



WARNING: Without the manual safety present and applied and with the chamber loaded, the pistol will fire when trigger is pressed completely to the rear even with NO magazine inserted.

Automatic Triple Drop Safety system (3DS) helps preventing accidental discharges in an event the pistol is dropped on a hard surface or struck when chamber is loaded (see Safety features, Pg. 13). The AREX *delta* may be factory equipped with an additional (optional) ambidextrous manual safety. The safety may also be retrofitted to any AREX *delta* pistol by a qualified gunsmith with only a slight modification to the frame. Optional manual safety helps preventing unintentional discharges by preventing the pistol to fire even if the trigger is depressed.

A special quick disassembly system that enables the slide to be lifted from the frame enabled us to engineer the AREX *delta* with lower part count and employ a slide backplate with no cutouts. Adding the proven AREX internal extractor and an innovative internal slide stop notch to the equation has resulted in a stronger and perfectly sealed construction. Disassembly may be performed even without manipulation of the trigger, enhancing an already impressive safety portfolio of the AREX *delta*.

Quality of the AREX *delta* pistols is maintained by constant internal quality control according to ISO 9001:2015 standard. AREX *delta* pistol has shown excellent reliability with high Mean Rounds Between Stoppages counts achieved during extensive pre-manufacture testing both in-house as well as in the field. AREX *delta* pistols are proudly made in Arex's factory in Slovenia, EU. The AREX *delta* is well suited for long term duty carry and for civilian concealed carry and is covered by Arex's warranty.

NOMENCLATURE

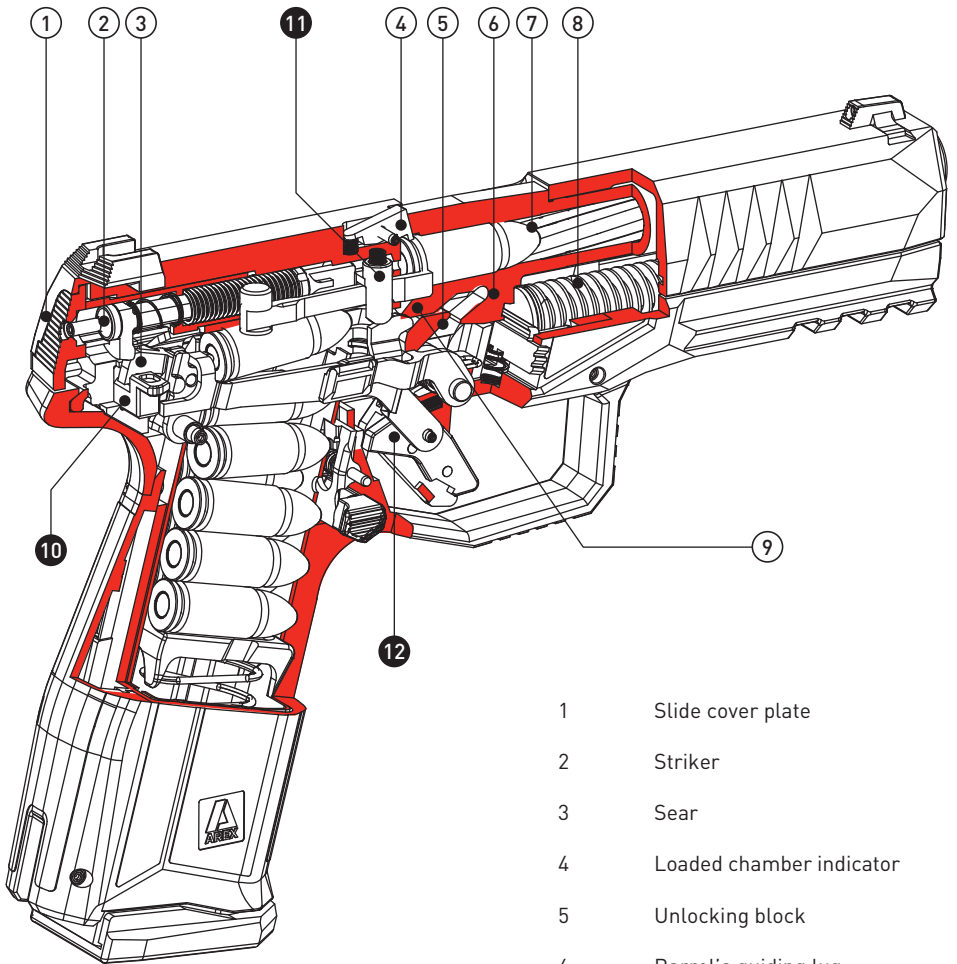
Figure 1 — AREX *delta* (cutaway view)

- | | |
|----|--------------------------|
| 1 | Slide cover plate |
| 2 | Striker |
| 3 | Sear |
| 4 | Loaded chamber indicator |
| 5 | Unlocking block |
| 6 | Barrel's guiding lug |
| 7 | Cartridge in the chamber |
| 8 | Recoil spring assembly |
| 9 | Feed ramp |
| 10 | Sear Safety Ramp |
| 11 | Striker Block |
| 12 | Trigger Safety Latch |

3DS Safety system

Figure 2 — AREX *delta* L (left side view)



- 1 Front sight w/ contrast white dot or tritium inserts (optional)
- 2 Contoured slide
- 3 Disassembly latch, left
- 4 Loaded chamber indicator (raised: cartridge present in the chamber)
- 5 Slide catch/release, left
- 6 Rear slide serrations
- 7 Magazine release button, left
- 8 Polymer frame
- 9 Replaceable rear grip strap
- 10 Magazine floorplate (standard capacity)
- M Size comparison between models L and M

Figure 3 — AREX *delta* L (right side view)



- 1 Partially cocked striker indicator
- 2 No-snag rear sight (optional tritium night sight)
- 3 Slide catch/release, right
- 4 Ejection port
- 5 Disassembly latch, right
- 6 Picatinny rail
- 7 Front slide serrations
- 8 Trigger with integrated safety latch
- 9 Trigger guard
- 10 Magazine release button, right
- 11 magazine floorplate [+2]
- X Size comparison between models L and X

SECTION 3

SPECIFICATIONS

Caliber:	9mm Luger (9x19mm)
Operating Principle:	Short recoil
Action Type:	modified Browning linkless locking system
Automatic/Passive Safety:	- Trigger System: Striker Double Action (SDA) - Drop Safety: Triple Drop Safety system (3DS - trigger safety, sear safety ramp, striker block) - Disassembly safety: No trigger actuation necessary
Manual safety:	ambidextrous, frame mounted (optional)

DIMENSIONS & WEIGHT

Model	delta L/OR	delta M/OR	delta X/OR
Length	196 mm	181 mm	184 mm
Barrel Length	114 mm	102 mm	102 mm
Sight Radius	161 mm	152 mm	152 mm
Height w/o magazine	133 mm	121 mm	133 mm
Height with magazine	140 mm	128 mm	140 mm
Height with + 2 rd magazine	150 mm	138 mm	150 mm
Width (slide)	26 mm	26 mm	26 mm
Width (frame)	28 mm	28 mm	28 mm
Width (slide catch/release)	30 mm	30 mm	30 mm
Weight w/o magazine (w/o manual safety)	596 g/565 g	541 g/512 g	541 g/510 g
Weight w empty magazine (w/o manual safety)	676 g/646 g	615 g/586 g	622 g/591 g
Weight w full magazine (w/o manual safety)	887 g/856 g	801 g/772 g	833 g/802 g
Weight w full + 2 rd magazine (with manual safety)	926 g/895 g	840 g/811 g	871 g/840 g
Magazine capacity / +2 rd	17/19	15/17	17/19

OTHER DATA

Trigger Pull SDA	25 N (2.5 kg)
Trigger Travel SDA	5 mm
Reset Trigger Travel	2 mm
Barrel Profile/Twist	6 brazd in polj / desnosučni
Barrel Twist Rate	250 mm (1:10")

MISCELLANEOUS

Warranty:	24 months limited warranty for original retail purchaser. Please check www.arex.si/warranty for more information. For Law enforcement and Military warranty is based on contracts.
Accessory Rail:	MIL-STD-1913 profile rail located under dust cover — rated to 11 ounces (300 grams) load for accessory light, lasers and aimers
Durability:	Pistol passed all applicable tests according to NATO D14 test criteria
Disassembly:	No tools required for user disassembly, no trigger pull is necessary for disassembly. Minimal tools required for detailed, depot level disassembly

FUNCTION AND OPERATION**CYCLE OF OPERATION**

The cycle of operation is a repeating sequence of mechanical events taking place during operation of a self-loading firearm. The sequence for the AREX *delta* pistol begins with a loaded magazine inserted into the magazine well and the slide being released from its rearmost position.

1. Feeding: Removal of a round from the magazine

Racking the slide (pulling it briskly back to its rearmost position and releasing) or depressing the slide catch/release lever (if slide is locked to the rear) allows the recoil spring to expand, driving the slide forward. The bottom part of the slide's breechface [part of slide that closes the barrel], passes between the feed lips, stripping the top round from the magazine and pushing it towards the chamber. The bullet slides up the barrel's feed ramp, allowing the base of the cartridge to pivot upwards on the breechface.

2. Chambering: Placing and seating the round into the chamber of the barrel

The recoil spring continues to expand, driving the slide forward with breechface pushing the cartridge into the chamber. As the base of the cartridge pivots upwards, the slide mounted internal extractor engages the cartridge's rim. As the cartridge is completely chambered the slide's breechface comes in contact with the enlarged rear portion of the barrel and starts pushing it forward.

3. Locking: Closing and locking of the action prior to the shot

When slide pushes the barrel forward it forces the angled surfaces on its guiding lug against opposing angled surfaces on the unlocking block located in the frame. This action pivots the rear portion of the barrel upwards until its stepped forward edge engages the forward edge of the ejection port. As the enlarged rear portion of the barrel locks into slide's ejection port (the breech is locked), the striker is caught by the sear and partially cocked. The locking phase is completed when the slide reaches its forward limit of travel (i.e. slide is "in battery"). The partially cocked striker is visible through the opening on the slide's cover plate (red dot).

4. Firing: Ignition of the cartridge's primer and propellant

As the operator presses the trigger (moving it back), the striker is first fully cocked (visible through the slide cover plate opening) and then released (Striker Double Action - SDA). As the trigger approaches its rearmost position, the striker block plunger is automatically pushed up by the trigger bar so it unblocks the striker just before it is released by the sear. The striker, driven by the expansion of the striker spring, strikes forward, protruding through the hole in the slide's breechface, hitting the primer. The primer detonates, igniting the propellant gunpowder in the cartridge. The bullet is pushed out of the cartridge case and forced down the barrel by the expanding gases. Rifling inside the bore "grips" the bullet, making it spin, thus gyroscopically stabilizing its flight.

5. Unlocking: Removal of the blocking mechanism to allow the opening of the breech

The force of the expanding gases causes the bullet to move forward in the barrel but also pushes the cartridge case rearward against the slide's breechface, initially pushing both the slide and barrel back in unison since the barrel's enlarged rear portion is locked in the ejection port. The slide's ejection port pushes back on the stepped forward edge of the enlarged rear portion of the barrel and after approximately 4 millimeters of travel, the barrel is pulled downward due to the engagement of the angled surfaces on the barrel's guiding lug with those located on the frame mounted unlocking block. The unlocking block disengages the barrel from the slide (after another 4,5 millimeters of conjoined travel) and stops it while the slide continues moving rearward independent from the barrel.

6. Extracting: Removal of the fired cartridge case or live round from the chamber

With the barrel now arrested by the frame mounted unlocking block, the slide continues to move towards the rear. The internal slide mounted extractor, hooked to the cartridge case's rim, pulls the fired cartridge case (or live round - if the slide is retracted manually) from the chamber.

7. Ejecting: Expulsion of the fired cartridge case or live round from the firearm

The extractor mounted inside the slide on its right side, continues to pull the cartridge case (or live round - if the slide is retracted manually) rearwards. As the slide moves rearward, the base of the cartridge case is struck against the ejector, positioned in the left side of the frame, behind the magazine well. Extractor creates a moving pivot point on the right and the frame mounted ejector creates a stopping contact point on the left, rotating the cartridge case (or live round) to the right, ejecting it outwards through the ejection port on the right side of the slide.

8. Partial cocking: Resetting the striker to allow subsequent shots to be fired - Striker Double Action

In the first few millimeters of rearward travel, the slide passes over the disconnecter and presses it inward, releasing the sear and allowing it to spring to its uppermost position, regardless of the position of the trigger (if a shot has just been fired, the operator still holds the trigger to the rear). The sear is now ready to engage the striker and cock it partially when the slide closes.

9. Repeating or ending of the cycle of operation

Once fully to the rear, the compressed recoil spring pushes the slide forward, closing the action and taking the next cartridge from the magazine (if a cartridge is present) into the chamber while striker is held by the sear and its spring partially compressed. The pistol is again ready to fire with the partially cocked striker visible through the opening on the slide's cover plate (red dot). If the magazine is empty (e.g. the last round was fired), the magazine follower lifts the slide catch into position where it blocks the forward progress of the open slide thus holding it open.

SAFETY FEATURES

The AREX *delta* incorporates the following safety features:

1. Triple Drop Safety System (3DS)

The AREX *delta* is fitted with a reliable Triple layer passive Drop Safety system (3DS). The system consists of an automatic trigger safety, sear safety ramp and a striker block. All three safety features are constantly active unless the trigger is properly pressed. The automatic trigger safety prevents the trigger from moving until the pressure is applied directly to the trigger face, pushing the protruding lever into the trigger thus disengaging the first safety. Whenever the striker is partially cocked the second safety in the form of a sear safety ramp is active, preventing the sear's disengagement from the striker. Only when the trigger is pressed and the trigger bar moves the sear backward, cocking the striker completely, the sear clears the ramp and is allowed to lower upon further trigger pressure in order to release the striker. The third safety is a slide mounted striker block. When at rest, the spring loaded striker block plunger arrests the striker preventing it from moving forward in the striker tunnel. Only when the trigger is pressed and the striker becomes fully cocked, the trigger bar protrusion pushes up on the striker block plunger which unblocks the striker (providing the slide is in battery) allowing it to move forward when released by the sear. All three safety features help prevent accidental discharge from impact if the AREX *delta* is struck or dropped and all three reengage automatically as soon as the trigger is released.

2. Striker Double Action trigger (SDA)

The Striker Double Action trigger (SDA), is an advanced hybrid trigger (neither a traditional double nor a single-action). When a cartridge is loaded and the slide goes into battery the striker is only partially cocked and unlike with single-action mechanisms, initial trigger travel

is required to cock it fully. This distinct trigger movement (approximately 5 mm) may be stopped at any time giving the operator ability to abort initiated firing procedure, if needed. The SDA trigger also enables safer carry with a loaded chamber without the need for (optional) manual safety.

3. Disconnecter

The disconnecter ensures that the ARES *delta*'s slide must be in battery to enable the pistol to fire. When the action is open or only partially closed (i.e. slide is out of battery), the disconnecter, located under rear frame guide, is pushed inward by the slide, letting the sear spring upward ensuring positive striker engagement. Simultaneously the trigger bar is disengaged from the sear lever thus preventing the release of the striker and precluding firing even if trigger is depressed. In battery, a relief cut milled on the bottom of the slide allows the disconnecter to move outwards enabling the trigger bar to engage the sear lever, allowing the pistol to fire on trigger pressure.

4. Disassembly Safety

The disassembly safety ensures the striker is automatically decocked during the user disassembly procedure. Disassembly can be carried out even without manipulation of the trigger. In the event when the round was left in the chamber the striker will be safely decocked as the slide is removed from the frame. The striker remains blocked during disassembly process as long as fingers are kept outside of the trigger guard and the trigger is not actuated.



WARNING: Never start disassembly until you clear the ARES *delta* pistol and ensure it is devoid of all ammunition (see Clearing, Pg. 15).

5. Loaded Chamber Indicator

The loaded chamber indicator is located on the top of the ARES *delta*'s slide, just behind the barrel. It allows the operator to determine if there is a cartridge (or a cartridge case) inside the chamber, without opening the action (i.e. performing press-check). Indicator protruding above the slide surface, which can be seen and felt, indicates a loaded chamber.

6. Ambidextrous Manual Safety (optional)

The (optional) ambidextrous frame mounted manual safety also helps prevent accidental discharge by means of positively blocking the sear, which prevents the pistol from firing even if trigger is depressed. The manual safety is engaged or the pistol is put "on safe" if one of the ARES *delta*'s manual safety levers, positioned on both sides of the frame, is pushed in its upper position. This can be done when the striker is partially cocked. The pistol can be fired once the safety is disengaged (moved to its lower position). A red circular mark is visible on both sides of the slide, above safety lever (only on pistols factory equipped with manual safety), signifying manual safety is disengaged and pistol can be fired when trigger is depressed.



WARNING: Do not depend on the red color mark alone to indicate the status of the manual safety because it could be erased in time or it may not be present on your pistol.



WARNING: ARES *delta* pistol does not feature a magazine disconnect, and is able to fire even if the magazine is removed. Pistol will fire when a cartridge is in the chamber, the manual safety is not engaged (or not present) and the trigger is pressed.



WARNING: Never rely totally on mechanical safety devices. Like any mechanical device, a safety mechanism can fail or it can be inadvertently disengaged. Always keep the firearm pointed in a safe direction and finger off the trigger when not intentionally depressing it!

INSTRUCTIONS FOR USE

CLEARING

NOTE: Carry out this procedure whenever the firearm is picked up/handled without the intent to be fired immediately.

1. Point the muzzle of the AREX *delta* in a safe direction.

Ensure the muzzle of the AREX *delta* is pointed in a safe direction (see Safety rules, Pg. 2) and that the fingers are kept off the trigger and outside of the trigger guard at all times during firearm manipulation.

NOTE: It is a matter of good practice to rest the trigger finger on the frame and not on the front of the trigger guard (see Figure 6). AREX *delta*'s frame provides rough surfaces that can be tactily located by the trigger finger when it is placed along the frame.

2. Remove the magazine.

Depress either side of the ambidextrous magazine release button and remove the magazine from the magazine well (see Figure 4).

NOTE: Magazine will fall free from the magazine well when the magazine release button is depressed. The absence of the magazine should always be verified by inserting a finger in the magazine well at the bottom of the grip.

3. Open the action

Grasping the front or rear slide serrations, swiftly rack the slide (pulling it briskly back to its rearmost position and releasing) while keeping the muzzle pointed in a safe direction (see Figure 5). Watch for a cartridge (or an empty case) to be ejected out through the ejection port. Retract the slide fully the second time (see Figure 6). If another cartridge is ejected, STOP immediately and remove the magazine from the pistol (go back to step 2). You can hold the slide to the rear or lock it to the rear by pushing upwards on the slide catch/release lever at this point.

NOTE: Use front slide serrations to manipulate the slide if the (optional) safety is engaged during the clearing procedure.



WARNING: When using front slide serrations take extra care to keep your hands and fingers away from the muzzle while grasping the slide.

4. Inspect the chamber and magazine well.

Inspect the chamber for the presence of a cartridge or an empty case by looking through the open ejection port into the chamber, visually verifying that the chamber is indeed empty (see Figure 6). Verify that the magazine is not present in the magazine well (see Figure 7), if it is present, STOP immediately and remove the magazine from the pistol (go back to step 2). If visual inspection is not possible a finger should be physically inserted through the ejection port and the chamber felt for the presence of a round or an empty case.



WARNING: If the slide is closed when the finger is inside the ejection port, injury may occur.

5. Remove any ammunition.

Remove any cartridges or empty cases that were not ejected, from the chamber and from within the magazine well of the AREX *delta* pistol.

NOTE: When the above described procedure is executed, the AREX *delta* pistol is considered "CLEAR".

Figure 4,5,6,7: Clearing the AREX *delta* pistol



Figure 4 — Remove magazine



Figure 5 — retract slide: watch for ejected cartridge



Figure 6 — fully retract slide AGAIN:
no cartridge ejected/no cartridge present



Figure 7 — inspect chamber and magazine well:
no cartridge /no magazine present

ADJUSTING THE GRIP SIZE

NOTE: The pistol's grip should be adjusted to fit individual user's hand before first use and re-adjusted after some use, if need be.

Exchanging the grip back straps modifies the ergonomics and "shootability" of the pistol significantly and should be performed even if the installed "medium" backstrap feels OK. Proper size of the backstrap will ensure the correct grip angle, enhance natural pointing and aid when fast follow-up shots are called upon.



WARNING: Never start any disassembly until you clear the AREX *delta* pistol and ensure it is devoid of all ammunition (see Clearing, Pg. 15).

To adjust the grip of the AREX *delta* pistol, remove the pre-installed back strap (marked M for "medium") and install any one of the included additional three that best fit your shooting hand. Choose from S - "small", L - "large" and XL - "extra large" (see Figure 8). Installing the "extra large" backstrap will also extend the trigger reach of your pistol.

Exchanging the back strap:

1. Push out the grip back strap pin located at the bottom of the grip to either side using appropriate punch (3 mm, not included).
2. Remove back strap by pushing it downwards as far as it goes then taking it away from the grip (see Figure 9).
3. Reinstall desired back strap by pushing it upwards until the holes align.
4. Reinsert the removed lanyard pin (part.no. 46) and drive it in with a punch so it is centered in the grip.

NOTE: The cutout on the bottom of the back strap and the back strap pin can be used to secure the AREX *delta* pistol with a lanyard.



Figure 8 — Backstrap options, Medium installed



Figure 9 — Removing/installing the backstrap

AMMUNITION



WARNING: Arex d.o.o. specifically disclaims any responsibilities for any damage or injury that should occur because of, or as a result of, the use of faulty, remanufactured, or reloaded (hand loaded) ammunition, or of cartridges other than those for which the pistol was originally chambered for.

NOTE: The AREX *delta* pistol was designed to fire quality, factory-loaded ammunition, manufactured to European C.I.P. (Permanent International Commission for the Proof of Small Arms) or US SAAMI (Sporting Arms and Ammunition Manufacturers' Institute) specifications for use specifically in handguns.

The following guidelines should be considered when selecting the correct ammunition for your pistol:

1. Be sure the ammunition you have chosen is compatible with your pistol - proper caliber, cartridge, bullet weight, etc. Caliber markings on the AREX *delta* pistol appear on the left side of the slide as well as on the rear portion of the barrel and are visible through the ejection port on the right side of the slide.



WARNING: Using the wrong ammunition could result in serious injury or death. Catastrophic damage to the firearm could occur.

2. Prior to loading the pistol, carefully inspect all cartridges for the following abnormalities:

- Cracked, split, dirty or corroded case
- Improperly seated projectile and/or primer
- Damaged projectile
- Projectile has been forced back into the case.



WARNING: Do not attempt to load or fire any of such cartridges. Upon firing, these conditions may result in increased chamber pressure that is above safe limits.

3. Do not attempt to fire ammunition that:

- Is foreign and/or outdated military surplus
- Is assembled with corrosive primer and/or propellant
- Was exposed to oil, grease, water or direct sunlight. If possible, remove contaminants before use and cool down ammunition exposed to direct sunlight or heat. (Exposure to sources of heat could raise the chamber pressure of the cartridge above safe limits.)
- Is loaded specifically for use in submachine guns.



WARNING: Arex firearms are designed to function safely and reliably with a wide range of quality manufactured brass-cased ammunition loaded to commercial (C.I.P., SAAMI) or military (NATO) standards. Use of cast-lead bullets is not recommended.

FILLING THE MAGAZINE

NOTE: Do not attempt to load more than the declared maximum number of cartridges into the magazine. Do not alter the shape of the magazine housing, follower or spring. To do so may cause stoppages or the magazine may not seat properly in the pistol.

To fill the magazine:

1. Hold the magazine with the back side of the magazine resting against the palm of your hand and its bottom preferably resting on a hard surface (e.g. tabletop).
2. Using the support (i.e. non-firing) hand, hold a cartridge to be loaded between the index finger and thumb with the bullet facing the palm.
3. Press the base of this cartridge down against the forward edge of the magazine follower or against the top cartridge already in the magazine with the thumb of the firing hand. Use the thumb and index finger of the support hand to prevent the cartridge from slipping to either side of the top one already in the magazine (see Figure 10).
4. Push the cartridge into the magazine all the way under the magazine feed lips with the base first.
5. Repeat steps 1-4 until the magazine is filled to capacity. The numbered witness holes in the back of the magazine allow the operator to confirm the number of cartridges loaded in the magazine (see Figure 11).

NOTE: Observe the proper orientation of the cartridges. The magazine may allow cartridges to be loaded with bullets turned backwards in which case the firearm will not function and the cartridge may jam inside the chamber if an improperly loaded magazine is inserted and slide racked.

EMPTYING THE MAGAZINE

Holding the magazine with its back side resting against the palm of your hand, exert pressure with a thumb on the base of the top cartridge and push cartridges forward and out of the magazine one at a time, until the magazine is empty (see Figure 12).



WARNING: Catch the expelled cartridges when you empty the magazine. Impact from the fall can ignite a cartridge and cause serious injury.



Figure 10
Filling the magazine

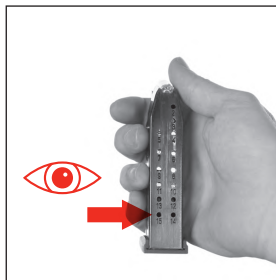

Figure 11
Numbered witness holes



Figure 12
Emptying the magazine

LOADING THE PISTOL



WARNING: Using excessive force when inserting a loaded magazine into the pistol may cause the opened slide to close, chambering a cartridge and making the pistol ready to fire. When loading the AREX *delta*, always ensure you are pointing the pistol in a safe direction with fingers off the trigger and outside of the trigger guard. Failure to do so could cause you to inadvertently fire the pistol, resulting in serious injury or death.

Administrative Loading - Used primarily to load the pistol when it is being prepared for carry or not intended to be fired immediately.

NOTE: Slide should be forward or locked to the back, chamber empty and magazine well empty before proceeding (see Clearing, Pg. 15).

1. Safety first - Make sure the pistol is pointed in a safe direction and fingers are outside of the trigger guard at all times during loading procedure except when purposely actuating the trigger!

NOTE: The AREX *delta* pistol was designed so that loading and/or unloading (i.e. clearing) may be performed with the (optional) manual safety engaged at all times. This can be used as an extra precaution against accidental discharge due to inadvertent trigger manipulation. This is however not obligatory if operator ensures that the fingers are kept off the trigger and outside of the trigger guard at all times during firearm manipulation. Front serrations should be used to manipulate the slide whenever manual safety is engaged.



WARNING: When using front slide serrations take extra care to keep your hands and fingers away from the muzzle while grasping the slide.

2. Insert the magazine - Insert the magazine filled with desired number of cartridges firmly into the magazine well (see Figure 13). Tug on the magazine floorplate to insure that it is fully seated and the catch has positively engaged.

NOTE: The magazine floorplates and the bottom of the grip were purposely designed to allow the magazine to be grasped firmly. There is also a distinct clearance between the bottom of the grip and inserted magazine floorplate.

3. Chamber a cartridge - Chamber a cartridge by depressing the slide catch/release (when slide is locked to the rear) or by pulling the slide fully to the rear and releasing it (see Figure 14).



WARNING: Make sure your fingers are clear of the ejection port when the slide is released to avoid possible injury.

NOTE: Do not ride the slide forward! The pistol was designed to load a cartridge by the force of the expanding recoil spring. Slowly closing the action (i.e. easing the slide forward) might cause the pistol to jam or not load the cartridge properly.

CAUTION: The pistol is now loaded and can be fired. When the (optional) manual safety is disengaged and the trigger is pressed, the pistol will fire. If the pistol is not to be fired immediately, proceed to the next step of the administrative loading process!

4. Engage the (optional) manual safety - Put the pistol “on safe” by moving the manual safety lever (if present) to its uppermost position (on the left or right side of the frame so it covers the red dot). The Striker Double Action trigger system (SDA) and the Triple Drop Safety system (3DS, see Safety Features , Pg. 13, see Figure 1) in the AREX *delta* pistol allows you to safely carry the AREX *delta* with a loaded chamber without the (optional) manual safety engaged or present thus achieving highest level of readiness. The pistol is now loaded and safe to carry in a holster.



WARNING: Risk of an accidental discharge - Although the AREX *delta* has been tested extensively to be “drop safe” even beyond heights associated with “normal” use, multiple strikes or a fall may compromise the safety system. Dropping or striking a firearm is considered misuse and safety systems should be inspected/replaced by a certified Arax armorer after such occurrences to ensure their proper function. Arax d.o.o. accepts no liability and provides no warranty for damage or injury arising from misuse of the firearm. With all safety systems functional the AREX *delta* will fire when a cartridge is in the chamber, the manual safety (if present) is not engaged and the trigger is pressed.

5. Check the chamber is loaded - Visually or tactilely verify that the loaded chamber indicator protrudes above the top surface of the slide, confirming the cartridge is loaded in the chamber (see Figure 15). It is not necessary to partially open the slide to perform the “press check”.

NOTE: When “press check” is used to verify the chamber is loaded and slide is retracted too much in the process, the loaded cartridge may be ejected. In this case reload the pistol as per instructions (see Loading, Pg. 20) or clear it (see Clearing, Pg. 15) as the need may be.



WARNING: Never rely solely on a loaded chamber indicator to confirm that the pistol is unloaded. The AREX *delta* pistol is fitted with a loaded chamber indicator, but it is a mechanical device, which could fail. Always remove the magazine, retract the slide fully twice and visually or physically check to make sure there is not a cartridge in the chamber (see Clearing, Pg. 15).



Figure 13
Inserting the magazine



Figure 14
Retract the slide using rear or front serrations and let close



Figure 15
Checking the loaded chamber indicator tactilely



WARNING: When using front slide serrations take extra care to keep your hands and fingers away from the muzzle.

SIGHTS AND AIMING

The AREX *delta* is equipped with low profile, no-snag sighting system. Front sight has a contrasting white dot for faster target acquisition and the rear sight is slanted so it would not snag on clothing during presentation and checkered to minimize glare. The sights are adjustable for both windage (by drifting the front sight) and elevation (by replacement of the front sight). Sights are installed and the pistol is carefully sighted in by Arex technicians at our factory. Only a competent gunsmith should adjust or replace the AREX *delta* sights. Figure 16 shows correct sight alignment, table below shows common aiming and impact points errors.

NOTE: Your AREX *delta* pistol was test fired at the Arex factory for accuracy by ensuring the point of aim equals point of impact at 15 meters (17 yards). Individual results concerning accuracy and/or shot placement are affected by such factors as shooting stance, firing grip, trigger technique, ammunition and target distance.

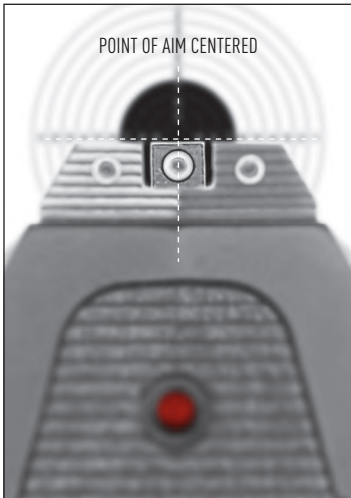

Figure 16 - Correct sight alignment (optional night sights)

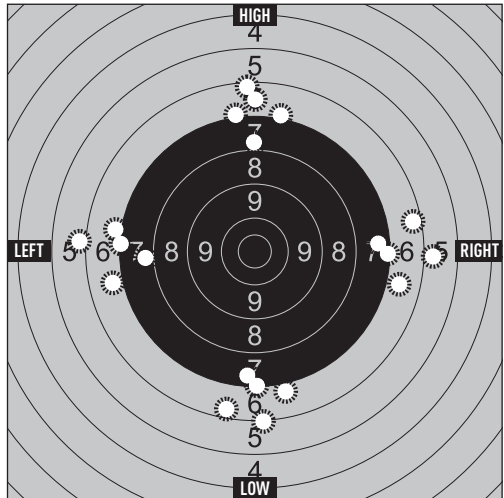

Figure 17 - Troubleshooting aiming/impact point errors

POSITION OF THE IMPACT POINT IN REGARD TO AIMING POINT (Figure 17)	POSSIBLE CAUSE	CORRECTIVE MEASURES
SHOTS HIGH ON TARGET	front sight too high in rear sight notch	lower/align front sight in rear sight notch
	front sight is too low	change front sight - install higher sight
SHOTS LOW ON TARGET	front sight too low in rear sight notch	elevate/align front sight in rear sight notch
	front sight is too high	change front sight - install lower sight
SHOTS LEFT ON TARGET	front sight left in rear sight notch	center front sight in rear sight notch
	front sight not set correctly - too right	drift adjust front sight - move it left
SHOTS RIGHT ON TARGET	front sight right in rear sight notch	center front sight in the rear sight notch
	front sight not set correctly - too left	drift adjust the front sight - move it right



WARNING: Clear the pistol before attempting to adjust the sights (see Clearing, Pg.15).

NOTE: Move the front sight opposite to the direction you want the point of impact to move. Always establish shot grouping on the target that represents your specific point of impact before adjusting or replacing the sights to correct it.

FIRING



WARNING: 1. Be sure of your target and what is behind it! Without proper backstop, a bullet fired from a pistol horizontally, travels much further than normal target distances. It can easily penetrate wood or plasterboard walls or even a car door.
2. Check striker block (see Assembly, Pg. 31) and perform basic function check (see Function check, Pg. 35) and ensure the barrel is free of obstructions.
3. Insure and check that you have the correct ammunition for the pistol.
4. Be sure that your hands and all parts of your body are kept away from the muzzle of the pistol and the slide's path.
5. Always wear eye and ear protection when firing the pistol.

Firing procedure:

1. **Point the pistol** at the intended target with your finger still resting on the frame (see Figure 18).
2. Properly **align the sights** and acquire correct sight picture (see Figure 16).
3. Gently put the finger on the trigger at this time and slow down or pause breathing shortly while aiming.
4. Gradually **press the trigger** straight to the rear cocking the striker fully while keeping the sights aligned and on target.
5. When a distinct "wall" is felt (trigger appears to stop), keep increasing the trigger pressure without moving the pistol (keep sights aligned and on target). Allow AREX *delta* to fire when adequate trigger pressure is reached.
6. Practice good **follow-through** after the shot breaks by maintaining sight picture and trigger pressure "throughout" the shot.
7. Keep pistol aimed at the target and continue to fire (repeat steps 2-6) as required or until the pistol is empty. **Remove the finger from the trigger** and rest it on the frame if you are not manipulating the trigger for the next shot or if the pistol is lowered or not pointing directly at the target.



WARNING: The slide moves backward and returns forward quickly during firing (see Figure 18). Keep your face and hands away from its path. Hot brass and powder gas is ejected quickly and can burn you. Always wear safety glasses and hearing protectors when firing a pistol or when near a pistol being fired.

NOTE: The AREX *delta* provides consistent trigger feel from first to last shot fired. Whenever the trigger is released, it will return to its foremost position requiring a longer trigger pull to fully cock the striker, thus ensuring additional margin of safety from unintentional discharges. The operator however, does not need to allow the trigger to move fully forward during fast consecutive shots since trigger resets after only 2 millimeters of forward travel after each shot. To achieve maximum efficiency and precision, operator should train to relieve pressure from the trigger just enough for the trigger mechanism to reset, keeping the striker fully cocked for the next shot.

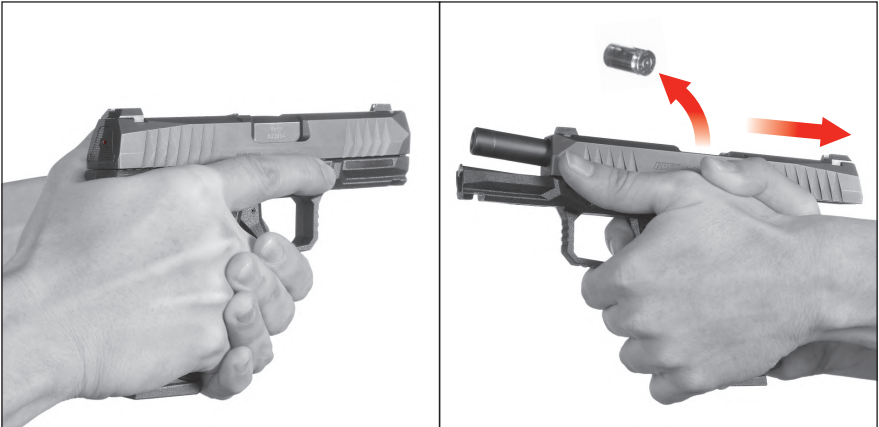

Figure 18 — Two-handed grip / Caution: reciprocating slide

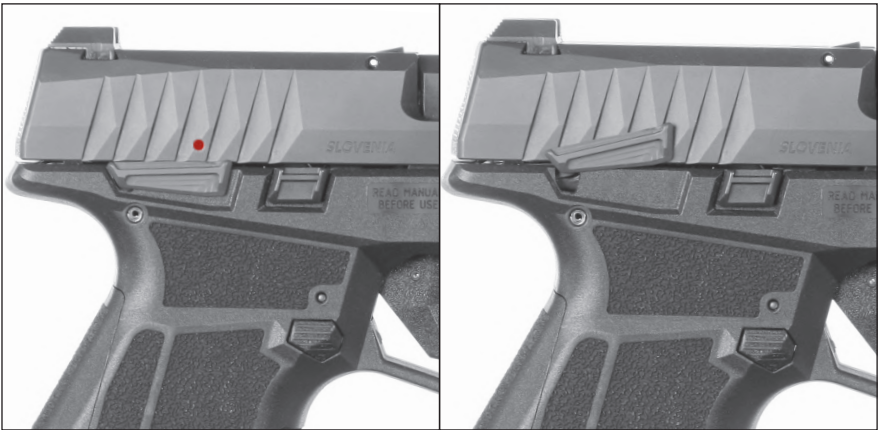

Figure 19 — Optional Manual Safety disengaged / engaged (right photo)

UNLOADING

The slide catch locks the slide open after the last round is fired if there are no more cartridges in the magazine. The spring loaded magazine follower of an empty magazine pushes up on the tab located inside the magazine well. This pivots the slide catch upwards, so that it engages a cut-out on the bottom of the slide, locking it to the rear after the last cartridge case is ejected. If the slide is retracted manually with an empty magazine inserted, the slide will remain locked open.



WARNING: Do not rely on the slide position to determine whether the pistol or the magazine is empty or not. Always check visually and physically to ensure the pistol is not loaded.

With slide locked back, the empty magazine can be removed by depressing either left or right magazine release button and visual or physical inspection of the chamber can be performed.



WARNING: Removing the magazine from the pistol does not prevent it from being fired! When there is a cartridge in the chamber, the manual safety (if present) disengaged and the trigger is pressed, the pistol will fire.

When the operator wishes to stop firing and unload the firearm before the last round is fired, the standard unloading procedure for the AREX *delta* is to be employed:

1. **Point the muzzle in a safe direction and keep the fingers off the trigger** and outside of the trigger guard at all times during firearm manipulation.
2. **Remove the magazine** by depressing the magazine release button on either side and remove the magazine from the magazine well (see Figure 20).
3. **Retract the slide fully to the rear twice**, watch for an ejected cartridge on the first retraction and hold it back on the second (see Figure 21,22), if a cartridge is ejected on second retraction, go back to STEP 2 and remove the magazine before retracting the slide again twice.
4. **Check the chamber and magazine well** for the presence of a cartridge and/or magazine visually or physically and remove if either is present (see Figure 22).

NOTE: The slide can be held to the rear or locked open by pushing upwards on ambidextrous slide catch/release lever for the purpose of inspection. Clearing procedure is explained in detail on Pg. 15.



Figure 20
Remove the magazine

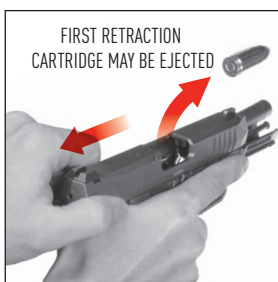

Figure 21
Briskly retract slide once:
watch for ejected cartridge

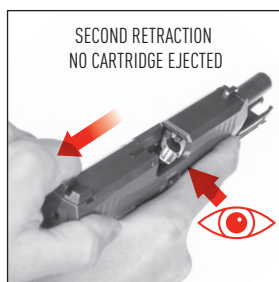

Figure 22
Retract slide AGAIN and hold
back: verify empty chamber

MALFUNCTION PROCEDURES

A stoppage (i.e. malfunction or “jam”) has occurred if:

- A cartridge fails to chamber (slide is out of battery)
- A cartridge fails to ignite
- A fired cartridge case fails to extract and/or eject from the pistol
- Unburned grains of propellant powder are present in the pistol
- A shot sounds or feels weak or abnormal



WARNING: If the pistol failed to fire upon pressing the trigger - STOP! A live cartridge may be present in the chamber! Keep the pistol pointed in a safe direction, remove your finger from the trigger, wait 30 seconds and CLEAR the pistol.

NOTE: A so called "hang fire" occurs when the trigger is depressed and a faulty round fails to fire instantly. The pistol fires eventually, but there is a delay between the time when the firing pin hits the primer and when the cartridge ignites. This may take several seconds. Do not turn the handgun away from the target and wait for at least 30 seconds in case the round fires with delay before clearing the pistol.



WARNING: If you hear a weak "pop" sound and/or feel or observe reduced or no recoil during firing or notice unburnt powder grains in the ejection port area- STOP! A bullet may be lodged in the barrel! Keep the pistol pointed in a safe direction, remove your finger from the trigger, CLEAR the pistol and disassemble it (see Disassembly, Pg. 28) to verify the barrel is clear of any obstructions.

NOTE: Always be sure that the barrel of your AREX *delta* pistol is clear of obstructions before firing. A so called "squib load", is a faulty round failing to propel the bullet out the barrel. An alert operator should be able to realize this occurrence and not attempt to load or fire another cartridge. If a bullet is stuck in the bore, never attempt to shoot it out by using another cartridge, a blank or a cartridge from which the bullet has been removed. This can generate excessive pressure, damage the firearm and cause serious personal injury or death.

To rectify a malfunction, follow the clearing procedure (see Clearing, Pg. 15), inspect the chamber and ejection port area for a cartridge or spent case and remove if either is present. If there is no obstruction in the barrel you may reload (see Loading, Pg. 20) and resume firing.

NOTE: If you suspect a bullet remained in the bore, disassemble your pistol and check whether the barrel is blocked. If there is a bullet lodged in the bore, do not try to remove it yourself if you are not familiar with the proper procedures. Take the pistol to a qualified gunsmith or contact your local Arex distributor (see details on the back cover).

Only in case you need to resume firing as soon as possible and the stoppage is not a result of a "squib load" or "hang fire", proceed with immediate action:

1. Keep the pistol pointed in a **safe direction** and **remove your finger** from the trigger guard.
2. **Hit the bottom of the magazine** with your support hand to ensure it is seated properly or to possibly free a magazine follower or spring hang-up.
3. Swiftly **rack the slide** by pulling it briskly back to its rearmost position and releasing. Do not ease the slide forward, let the force of the recoil spring do the work. This process should expel the bad cartridge or case from the chamber or ejection port and get a new round in the chamber while returning the slide back into battery.
4. Aim and **resume firing**.
5. If the pistol does not fire, **remove the magazine** from the magazine well, pulling it out if necessary (see Figure 4).
6. Fully **retract the slide several times** if necessary to remove any cartridge or cartridge case from the chamber or ejection port. Inspect the chamber and ejection port area for a cartridge or spent case and remove if either is present.
7. If the pistol is clear you may **reload the pistol to resume firing** or secure it if you do not intend to fire at that time.

NOTE: The magazine floorplates and the bottom of the grip were purposely designed to allow the magazine to be grasped firmly. There is also a distinct clearance between the bottom of the grip and inserted magazine floorplate.

NOTE: There are other efficient procedures that can be followed when clearing malfunctions. Any malfunction clearing method not described herein should only be attempted with appropriate training and understanding of the specific firearm, its state and inherent risks.

STORAGE AND TRANSPORT

1. Store and transport the pistol without any cartridges in the chamber or in the inserted magazine, or in the place of storage/transport container.
2. Store and transport the pistol with the slide forward (closed).
3. Store or transport the pistol and its components clean and lubricated.
4. Clean and lubricate the pistol and its components at least every twelve (12) months during storage.
5. Store the pistol and its components in a clean, dry, dust-free environment with stable room temperature.
6. Store the pistol and ammunition separately and securely locked.

SELECTION AND USE OF A HOLSTER



WARNING: A loaded pistol must never be holstered unless the holster has been checked and verified for safety and fit. Chosen holster must not interfere with the trigger during holstering/unholstering and must cover the trigger completely, making it inaccessible during carry. Proper verification of the holster must be carried out or injury or death could occur.

Selection - When selecting a carrying holster for the AREX *delta* pistol, it is important to consider the following points:

1. The holster must not make contact with trigger or actuate any of the operating controls during holstering/unholstering or during carry. This includes the ambidextrous slide catch/release, magazine release buttons and (optional) safety levers.
2. The holster must not cause the slide to move back/unlock when the pistol is holstered.
3. If the pistol is equipped with an accessory mounted on the dustcover this must be taken into account when selecting a holster.
4. If possible, choose a holster designed specifically for the AREX *delta* pistol. A list of manufacturers that make adequate holsters will be available at the Arex website or by contacting your local Arex distributor (see details on the back cover).



WARNING: Never carry your AREX *delta* pistol with a loaded chamber out of a suitable holster.

DISASSEMBLY & ASSEMBLY

DISASSEMBLY

The level of user disassembly described herein (also referred to as "field stripping") is sufficient to allow for proper cleaning & maintenance of the AREX *delta* pistol. Further disassembly should only be done by a qualified gunsmith or certified Arex armorers.



WARNING: Before attempting to disassemble the AREX *delta* pistol, make sure it is completely unloaded - clear. This includes the magazine and chamber.

1. Clear the AREX *delta* (see Clearing, Pg.15)!

NOTE: You do not need to operate the trigger to enable disassembly. The pistol should however, be disassembled after the trigger has been depressed following the clearing procedure. Do this with the muzzle pointed in a safe direction.

2. With slide closed ("in battery") move the slide back for less than 2 millimeters and hold it in that position. You can do that by hooking your index finger over the rear sight pulling it back slightly with thumb against the back of the grip (see Figure 23).
3. With slide held just slightly back, the disassembly latch may be pulled down on both sides of the frame using the other hand (see Figure 24).
4. With disassembly latch held down, release the slide and push it forward approx. 4 millimeters and lift it from the frame (see Figure 25).

NOTE: The striker will decock in the process if it was partially cocked prior to disassembly (red dot visible in the slide cover plate opening).



Figure 23
Pulling slide back slightly and holding it



Figure 24
Pulling down the locking latch on both sides of the frame then pushing slide forward



Figure 25
Lifting the slide from the frame

5. Turn the slide upside down, push the recoil spring assembly forward a few millimeters and carefully lift it out of slide (see Figure 26).

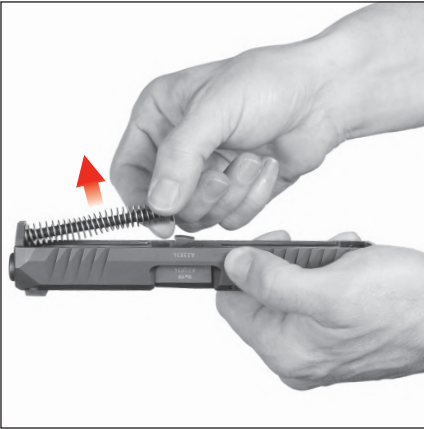

Figure 26 — Removing the recoil spring assembly. Note: the recoil spring is captive.

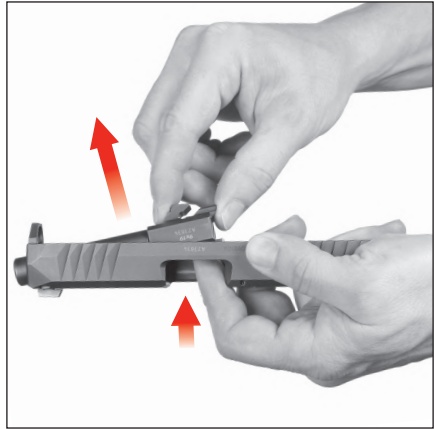

Figure 27 — Removing the barrel from the slide by lifting it up

6. With the slide still upside down, take the barrel out of the slide by pushing up on the rear portion of the barrel through the ejection port, lifting it out, and separating it from the slide (see Figure 27).



WARNING: Do not attempt to disassemble your pistol beyond the point explained in this manual.

MAGAZINE DISASSEMBLY

CAUTION: Be aware the magazine spring is under tension when removing and installing the magazine floorplate. Keep the base of the magazine pointed away from the face and eyes at all times during disassembly and reassembly. Wear eye protection.

Disassembly of regular-capacity magazines

1. Using a flat screwdriver, slightly lift the locking detent located in the floorplate and keep it lifted (see Figure 28).
2. Slowly slide the floorplate forward off the magazine housing with thumb over the base of the magazine to control the release of the magazine spring (see Figure 29).
3. Gradually allow the magazine spring to expand and take it out of the magazine housing (see Figure 30).

NOTE: This level of disassembly is sufficient to allow thorough cleaning of the magazine components.

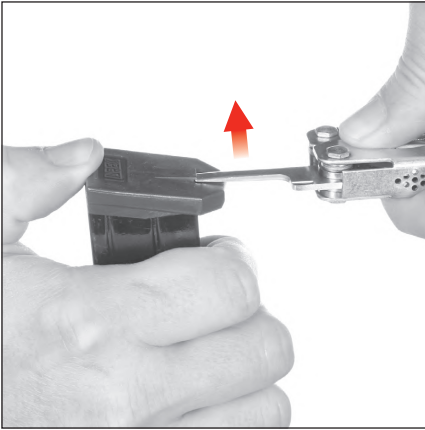

Figure 28 — Lifting the locking detent slightly using a flat tool

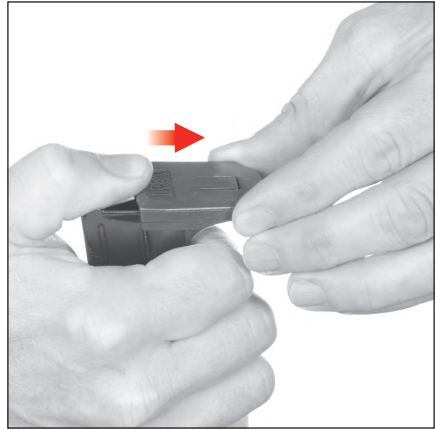

Figure 29 — Sliding the floorplate forward
Caution: spring under tension!



Figure 30 — Removing the spring with follower

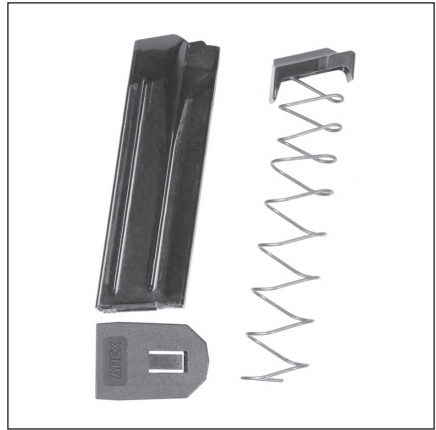

Figure 31 — magazine components

DISASSEMBLY OF PLUS 2 MAGAZINES

1. Use the tip of your thumb or thumbnail to slide the slotted locking plate tab located on the back side of the magazine away and clear of the magazine floorplate and hold it there (see Figure 32).
2. While pressing the locking plate by the tab against the back side of the magazine, slowly slide the floorplate forward off the magazine housing (see Figure 33).
3. Place the palm of either hand over the base of the magazine to control the expansion of the magazine spring and locking plate. Gradually allowing the locking plate and magazine spring to expand out of the magazine housing (see Figure 34).
4. Remove the locking plate, magazine spring and magazine follower from the magazine housing (see Figure 35).

NOTE: This level of disassembly is sufficient to allow a thorough cleaning of the magazine components.



Figure 32 — Pulling on the locking plate tab to free the floorplate



Figure 33 — Sliding the floorplate forward
Caution: spring under tension!

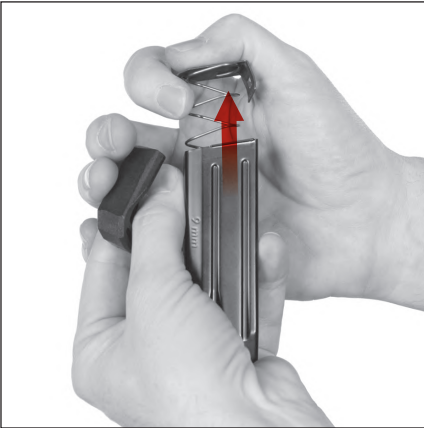

Figure 34 — Controlling the expansion of the magazine spring with palm, removing it from the housing.

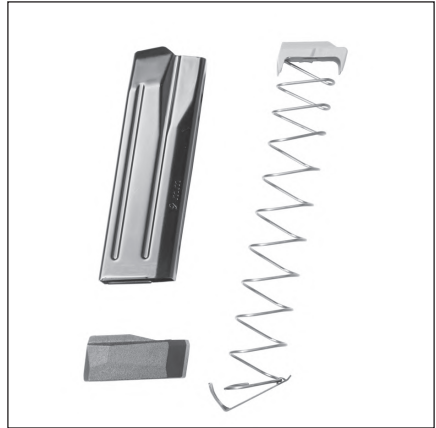

Figure 35 — 17-round (PLUS 2) magazine components

ASSEMBLY

Checking the striker block

Prior to assembly you should always routinely check if the striker block is functioning properly by turning the slide upside down, pulling the striker back and trying to push it forward. It should not protrude from the breechface (see Figure 36). Only with the striker block plunger depressed (this occurs when trigger is depressed) can the striker be pushed forward, making it protrude through the breechface (see Figure 37). When released (keeping the striker block plunger depressed) striker should be pulled back into the breechface by the striker rebound spring.



WARNING: Never use the firearm if it fails the striker block check. If this essential safety feature is compromised the pistol might fire if struck or dropped or if disassembly is attempted with a loaded chamber.

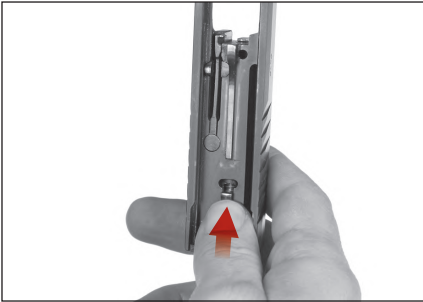

Figure 36 — Verify striker block function - striker should not move forward under pressure

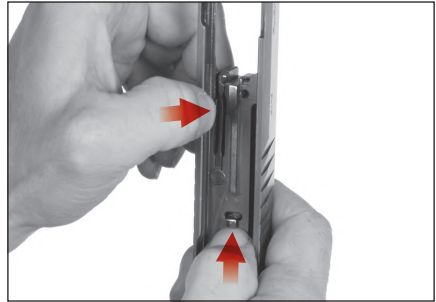

Figure 37 — Depressing striker block plunger will allow striker to be pushed forward

1. Keep the slide upside down and insert the barrel into the slide, muzzle first, with the flat side of the enlarged back portion facing downwards until it seats into the slide's ejection port (see Figure 38).
2. Insert the stepped end of the recoil spring assembly into the opening in front of the slide, below the muzzle (see Figure 39).
3. Push the recoil spring assembly forward into position, compressing the recoil spring just slightly to position the flat end of the recoil spring guide in front of the barrel's guiding lug on its circular recess (see Figure 40). Note a slight gap between the barrel's guiding lug and the recoil spring guide which is not resting on the top flat shelf of the barrel's guiding lug.

NOTE: If the recoil spring assembly is positioned with the flat end of the recoil spring guide forward and the stepped end backward, the pistol cannot be assembled.

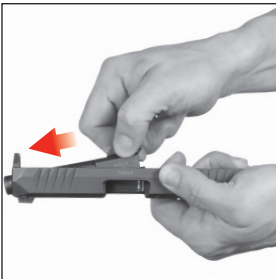

Figure 38
Inserting the barrel into the slide so it locks in the ejection port



Figure 39
Inserting the stepped end of the recoil spring assembly into the front of the slide

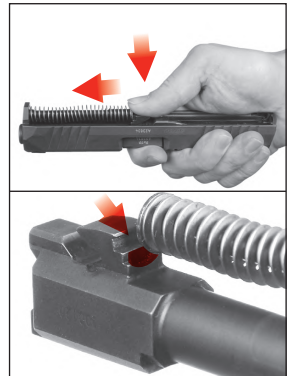

Figure 40
Positioning the flat end of recoil spring guide on a circular shelf in front of barrel's guiding lug

4. Ensuring that NO magazine is present in the magazine well, place the slide onto the frame, aligning the cutouts at the bottom of the slide with frame guides (see Figure 41).
5. Push the slide down against the pressure of the disassembly latch spring (see Figure 42) and move it backward slightly until you hear and see the disassembly latch engage (it springs up on both sides of the frame, see Figure 43).
6. Perform function check (see Function check, Pg. 35).

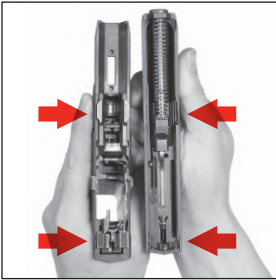

Figure 41
Four cutouts at the bottom of the slide will accept the four frame guides



Figure 42
Placing the slide on the frame (note slide is slightly forward in regard to its closed position)



Figure 43
Push the slide down and pull it back seeing the disassembly latch spring up

MAGAZINE ASSEMBLY

ASSEMBLY OF REGULAR-CAPACITY MAGAZINES

Start at step 2 if the magazine follower is already attached to the spring.

1. Place the magazine spring in the magazine follower so the narrower end of the spring snaps in the recess at the bottom of the follower (top front part of the follower is pointing up).
2. Insert the follower and magazine spring into the magazine housing compressing the magazine spring (see Figure 44,45).
3. Push the spring into the magazine housing and hold it there while sliding the floorplate all the way onto the guides until the detent locks in place (see Figure 46).



WARNING: The magazine spring is brought under tension in this process. If released prematurely, it can be expelled from the magazine body causing injury or damage. Point it away from the face and eyes. Wear eye protection.

NOTE: Check the magazine for proper function by insuring that the follower slides up and down within the magazine housing freely under spring tension. Also, check that the magazine follower rests at the top of the magazine housing, with its highest edge almost in line with the magazine feed lips.

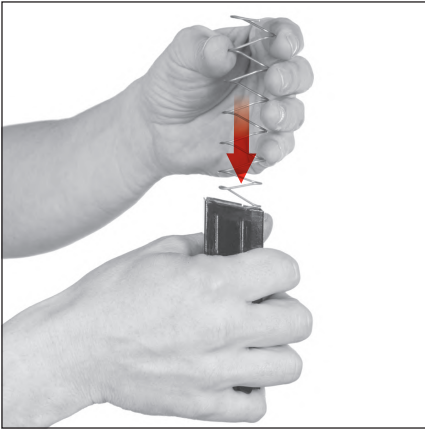

Figure 44 — Insert the follower and spring



Figure 45 — Compress the spring into the magazine body while sliding the floorplate onto guides



Figure 46 — Push the floorplate all the way back until detent clicks in place

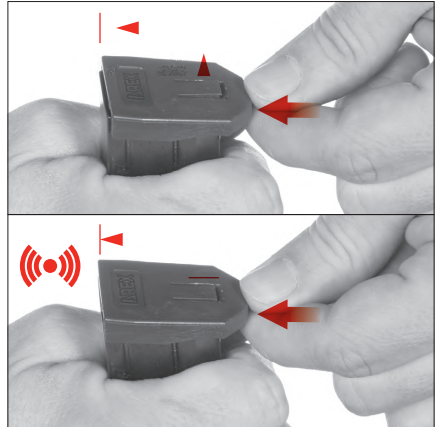

Figure 47 — Check the floorplate is arrested (detent not elevated)

ASSEMBLY OF PLUS 2 MAGAZINES

Start at step 3 if the magazine follower and the locking plate are already attached to the spring.

1. Place the magazine spring in the magazine follower so the top loop at the narrower end of the spring snaps under the tabs at the bottom of the follower (top front part of the follower is pointing up).
2. Place the locking plate onto the wider end of the magazine spring by guiding the spring through the loop in the plate orienting the slotted tab up and towards the back of the magazine.
3. Insert the follower and magazine spring into the magazine housing compressing the magazine spring (see Figure 48).



WARNING: The magazine spring is brought under tension in this process. If released prematurely, it can be expelled from the magazine body causing injury or damage. Point it away from the face and eyes. Wear eye protection.

4. Hold the locking plate against the bottom of the magazine housing with slotted tab on the outside of the back side of the magazine (see Figure 49).
5. Align the floorplate onto guides and slide it from the front all the way until the locking plate slips into the floorplate arresting it (see Figure 50).

NOTE: Check the magazine for proper function by insuring that the follower slides up and down within the magazine housing freely under spring tension. Also, check that the magazine follower rests at the top of the magazine housing, with its highest edge almost in line with the magazine feed lips.

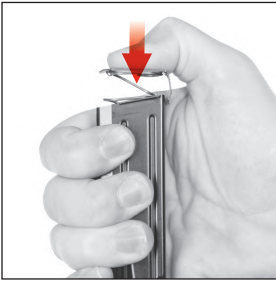

Figure 48
Insert the spring with follower and locking plate attached to it

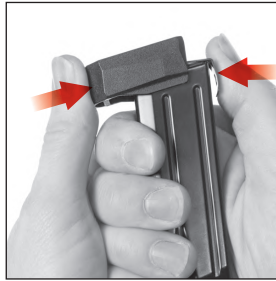

Figure 49
Hold the locking plate while sliding the floorplate onto guides

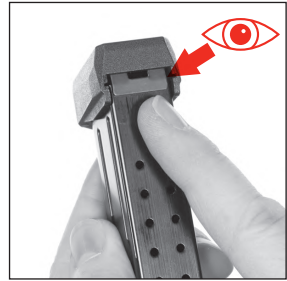

Figure 50
Check the floorplate is arrested by the locking plate

FUNCTION CHECK

It is essential that a basic function check be performed on the AREX *delta* every time after assembly to ensure that the firearm's components have been installed correctly. Below sequence is not random but can be changed if operator knows and understands the pistol's functions.

1. Clear the AREX *delta* (see Clearing, Pg.15)!
2. **Slide action** - Ensuring that fingers are off the trigger and outside the trigger guard, rack the slide (pulling it briskly to its rearmost position and releasing) three or four times. The slide should be able to glide smoothly back and snap forward, under the tension of the recoil spring, without binding or locking up.
3. **Striker partially cocking** - Return the slide into battery and check the striker - red dot should be visible through the slide cover plate opening indicating it is partly cocked.
4. **Striker Double Action trigger** - Keeping the unloaded pistol pointed in a safe direction, press the trigger of the AREX *delta* - striker (with a red dot at the end) should protrude slightly through the opening of the slide cover plate before striking forward and disappearing.

5. **Disconnecter function** - While maintaining backward pressure on the trigger, keeping it fully depressed, rack the slide to the rear and release it, holding the trigger to the back, until the slide returns to battery (protruding, fully cocked striker should be visible). Release the trigger - it should return to its forward position (audible and felt "click" after it moves forward 2 mm) - the striker should remain partially cocked (red dot visible through the slide cover plate).

6. **Trigger safety latch** - With the muzzle pointed in a safe direction grasp both sides of the trigger (without touching or depressing the trigger safety latch) and try to pull the trigger to the rear (see Figure 51). The trigger safety latch should prevent rearward movement of the trigger and the striker should not be fully cocked and released (red dot should be visible through the slide cover plate opening indicating striker is partly cocked).

7. **Slide catch-release function** - Insert an empty magazine in the magazine well and rack the slide to rear. The slide should lock open with an empty magazine inserted. Depress the magazine release button (left or right) and remove the magazine from the pistol. Push down on the slide catch/release lever. The slide should snap forward and return to battery (close completely).

8. **Manual safety function** - Engage the (optional) safety (i.e. push the safety lever to its upper position on either side of the frame - to do so, striker must be partially cocked - red dot visible through the slide cover plate) and press the trigger with the pistol pointing in a safe direction. The trigger should be blocked and not move backward and the pistol should not dry-fire upon pressing the trigger. When trigger is relieved of pressure, striker should remain partially cocked (red dot visible through the slide cover plate). Disengage the safety (i.e. push the safety lever to its lower position) and press the trigger while keeping the unloaded pistol pointed in a safe direction. The striker should protrude slightly through the opening of the slide cover plate before striking forward and disappearing. When trigger is relieved of pressure it should not return to its forward position - striker is not cocked. The (optional) manual safety may only be engaged when striker is partially cocked (after the slide has been pulled fully rearward and released). Front serrations enable easier slide manipulation whenever (optional) manual safety is engaged.



WARNING: Never use a firearm that shows signs of damage or fails any of the points in above function check. If the condition or function of the pistol or magazine is suspect, contact your local Arex distributor to determine if either the pistol or magazine should be sent in for service.

Contact your local Arex distributor (see details on the back cover) or Arex Customer Service Department by email: support@arex.si if you encounter any problems attempting to disassemble, assemble, and/or conduct a function check on the AREX *delta* pistol.

Figure 51
Checking the trigger safety - trigger should not move rearward under pressure if the safety latch is not depressed

CLEANING & MAINTENANCE

CLEANING

NOTE: The service life and performance of your AREX *delta* pistol is dependent upon proper care and maintenance.

Materials Required - we suggest you use at least the following cleaning set and materials to properly clean the AREX *delta* pistol:

- Appropriate cleaning rod with handle
- Patch holder
- Nylon bore brush (in the appropriate caliber)
- Bronze bore brush (in the appropriate caliber)
- Cotton bore mop
- Cleaning patches
- Lint-free wiping rag
- Cleaning solvent/lubricant

Cleaning Intervals - Regular and Extensive are the two types of operator cleaning for the AREX *delta* pistol. The recommended cleaning schedule is considered adequate if only quality factory loaded ammunition with non-corrosive primers is used.

Regular Cleaning - Performed after firing every 500 cartridges or every twelve (12) months.

Extensive Cleaning - Often referred to as "detailed cleaning." Performed after the firing of every 2,500 cartridges or whenever the pistol has been exposed to or immersed in sand, dust, water (especially seawater) or other foreign contaminants.



WARNING: Always clear the pistol before proceeding to disassembly and cleaning (see Clearing, Pg.15)! Wear eye protection and follow other precautions stipulated by the manufacturer when using cleaning solvents/lubricants.

Regular Cleaning

Barrel

- Saturate the bronze or nylon bore brush with solvent and push it through the bore from chamber to muzzle one or two passes, one direction preferably.
- After applying the solvent, set the barrel aside while cleaning slide and frame.
- After leaving the solvent in the bore for 5-10 minutes, run the bronze or nylon bore brush through the bore from chamber to muzzle at least five passes, one direction preferably, to remove any fouling.
- Use patch holder to run cleaning patches through the bore from chamber to muzzle, removing fouling or solvent residue. Change the patches until a clean one emerges from the muzzle end of the barrel.
- Brush or wipe the exterior of the barrel with the nylon brush and rag moistened with solvent to remove fouling.

NOTE: Moisten the cotton bore mop with lubricant and run it through the barrel to apply a thin oil film to complete the bore cleaning process if the pistol is to be stored, not carried.

CAUTION: We do not recommend the use of a steel bore brush to avoid scratching the bore thus reducing accuracy in the long run. If the cleaning solvent is not safe for the skin, it is not recommended for use with the AREX *delta* pistol.

Slide

- Gently brush all internal surfaces of the slide using the nylon brush moistened with solvent.
- Remove all surface fouling from internal and external surfaces of the slide using a rag.

Recoil spring assembly

- Remove all visible fouling using solvent and a nylon brush or a rag.

Frame

- Scrub all visible internal surfaces where carbon fouling is present using the nylon brush.
- Using a rag and cleaning patches, remove all fouling from accessible internal and all external surfaces of the frame.

Magazine

- Scrub the magazine follower and feed lips, using the nylon brush moistened with solvent.
- Using a rag, remove all fouling from all external surfaces of the magazine.

Extensive Cleaning

Extensive cleaning is the same as regular cleaning except that:

- The magazine is disassembled for cleaning.
- All parts should be either rinsed with or completely immersed in cleaning solvent and thoroughly scrubbed with a nylon brush. Compressed air should then be used to remove the loose fouling/contaminants and excess solvent and to dry all assemblies and components.

NOTE: Cleaning should always be followed by lubrication to prepare the AREX *delta* pistol for operation (see Lubrication, Pg. 39).

NOTE: The AREX *delta* pistol can be cleaned using an ultrasonic cleaning solution. However, the use of ultrasonic cleaning can result in the unwanted removal of colored safety reference markings on the slide (optional) or on the striker. Use of ultrasonic cleaning is normally neither necessary nor recommended. All components must be thoroughly dried and properly lubricated after being immersed in solvents or cleaning solutions of any kind before reassembly. For additional cleaning recommendations after use in extreme environments, please contact your local Arex distributor (see details on the back cover) or Arex Customer Service Department by email: support@arex.si

INSPECTION

During and after cleaning, visually inspect the pistol and its components for any irregularities that may cause problems or stoppages/jams during operation. Generally, you should always keep an eye on any of the discrepancies listed below.



WARNING: Always clear the pistol before conducting an inspection (see Clearing, Pg.15)!

Check for:

- Damaged or missing parts
- Improper assembly or function
- Absence of free movement, where expected
- Absence of spring tension, where expected

- Unexpected tolerances, movement and looseness
- Parts exhibiting signs of cracks, burrs, dents or obvious signs of damage or stress
- Lack of stops or tactile clicks, where expected
- General overall cleanliness
- Presence of inadequate or heavy lubrication
- Presence of corrosion or degradation of surfaces.

Note: The recoil spring is a high workload part and we recommend it be routinely changed after the firing of every 5,000 cartridges. We have chosen the flat wire helical recoil spring for its durability and ability to perform even after failure.

CAUTION: The AREX *delta* was designed to achieve optimal safety and exceptional reliability in an ergonomic and durable pistol. Do not try to “improve” the pistol by altering any of its components. Altering any part of the AREX *delta* or its magazines may cause serious injury or death and will void manufacturer’s warranty on the product.

LUBRICATION

Metal surfaces of the AREX *delta* pistol are treated with advanced corrosion and wear resistant finishes while polymer frame is impervious to corrosion. This does not mean that the firearm is maintenance free. It is imperative to properly lubricate the pistol to achieve reduced friction between interacting surfaces and ensure proper functioning. Any type of high-quality oil, specifically designed for use on firearms will work well on the AREX *delta*. Do not use lubricants that claim to be able to “creep” or penetrate metal as these substances may incapacitate primers in ammunition. Figure 52 shows areas on the pistol requiring particular attention to lubrication.



Figure 52 — Main components with medium lubrication points marked (right: slide underside)

Where and How Much

No lubrication (surface feels dry and is not slippery to the touch).

- Frame and all plastic components
- Ammunition
- Sights
- All external operating levers
- External accessories (e.g. lights, lasers)

Light lubrication (surface lubrication is visible but feels only slightly lubricated to the touch).

- Barrel exterior
- Bore and chamber **(during storage only)**
- All metal parts
- All internal parts in slide and frame
- Magazine spring
- Recoil spring assembly
- Magazine housing

Medium lubrication (surface feels slippery to the touch, but oil does not run down vertically held surfaces).

- The enlarged rear portion of the barrel: stepped forward edge and guiding lug
- Barrel unlocking block in the frame
- Slide grooves and frame guides
- Extractor
- Trigger axle, firing mechanism

Heavy lubrication (oil runs down the surface when it is held in a vertical position).

No heavy lubrication is required on the AREX *delta* pistols.

Re-apply lubricant periodically after firing the pistol as the heat will evaporate it. Apply lubricant using clean cotton swabs, patches or a rag. A spray bottle of lubricant may also be used directly when compressed air is used afterwards to circulate the lubricant into all parts and to remove the excess from the pistol.

TROUBLESHOOTING PROBLEMS AND REPAIR

Common causes of problems that are often overlooked include:

- Fouled, unlubricated or improperly lubricated pistol
- Bad ammunition
- Damaged magazines
- Operator error.

MALFUNCTION	CAUSE	CORRECTION
FEED		
No round fed into the chamber	Magazine not properly inserted	Insert magazine properly
	Magazine is deformed or dirty	Clean or replace magazine
	Incorrect or defective ammunition	Inspect and replace ammunition
Slide does not close easily or completely	Pistol or cartridge is fouled (dirty) or pistol is too heavily lubricated	Clean and lubricate pistol and/or replace the ammunition
	Incorrect ammunition	Replace ammunition
	Unknown	Pistol requires service
IGNITION		
Striker strikes but round does not fire	Faulty ammunition	Rack the slide to cycle next round and press the trigger again
	Striker obstructed/ damaged	Pistol requires cleaning/service
	Unknown	Pistol requires service
EXTRACTION/EJECTION		
After firing, the case stays in the chamber or is jammed in the ejection port	Insufficient recoil due to dirt	Clean and lubricate the pistol
	Slide movement slowed/blocked by the firing grip	Correct/change firing grip
	Light hold or limp wrist	Apply solid grip, rigid hold
	Low-powered ammunition	Change ammunition

EXTRACTION/EJECTION		
After firing, the case stays in the chamber or is jammed in the ejection port	Fouling in the extractor area	Clean the extractor area
	Damaged or broken extractor	Replace, pistol requires service
	Unknown	Pistol requires service
OTHER		
Slide is not locked open after last round fired	Magazine spring weak/defective	Replace spring or magazine
	Faulty ammunition	Replace ammunition
	Slide catch/release held down	Correct/change firing grip
	Slide catch/release damaged	Pistol requires service
Point of impact shifted laterally	Ammunition related	Change ammunition or adjust sights
	Front or rear sight shifted	Adjust, pistol requires service
Point of impact changed vertically	Ammunition related	Change ammunition or adjust sights
	Front sight damaged	Replace, pistol requires service



WARNING: If the pistol failed to fire - STOP! Keep the pistol pointed in a safe direction, remove your finger from the trigger, wait 30 seconds. A "hang fire" might have occurred and the cartridge could ignite with delay. Clear the pistol (see Clearing, Pg. 15) and examine the primer of ejected cartridge. If the striker indentation is light, off-center, or not present, the pistol might require cleaning or service - please contact your local Arex distributor. If the striker indentation on the primer appears similar to ones on previously fired empty cartridges, the cartridge may be defective.

SERVICE POLICY

If your AREX *delta* pistol still fails to function after applying malfunction procedures (see Malfunction Procedures, Pg. 25) and troubleshooting problems (see above table), please contact your local Arex distributor (see details on the back cover) or Arex Customer Service Department by email: support@arex.si to determine if it should be sent in for service and for the name and address of your nearest Authorized Repair Facility. Law enforcement users, contact your unit armorer or local Arex distributor (see details on the back cover).

WARRANTY REGISTRATION

New AREX firearms are covered with 24 months limited Warranty. The necessary condition for activation of warranty protection is an online registration of the purchased handgun within 30 days from the date of purchase (warranty registration card with QR code is included in the handgun box or go online www.arex.si/warranty-registration). Without online registration, the manufacturer will not accept the complaint. For more information you can contact customer service department by email: support@arex.si

OPTICS READY PLATFORM

AREX delta can be optionally factory equipped with a universal reflex optics platform (Arex Optics Ready) - a special recess milled into the slide. Five standardized mounting plates are included to provide secure and low profile interface for most proven miniature reflex sights ("red dots").



Figure OR1 - Rear view of reflex optics equipped Arex delta fitted with regular sights



Figure OR2 - Mount the reflex optical sight according to manufacturer's instructions

Specific Optics Ready interface plates accommodate the following brands of reflex optical sights (see Compatibility Table for more, Pg. 47):

- Docter/Noblex, Vortex, Burris, Sightmark, Delta Optical, Vector Optics - mounting plate OR type 1
- Trijicon, Holosun, Vector Optics, Swampfox - mounting plate OR type 2
- Leupold - mounting plate OR type 3
- C-more, Delta Optical, Vortex - mounting plate OR type 4
- Shield, Holosun, Swampfox - mounting plate OR type 5

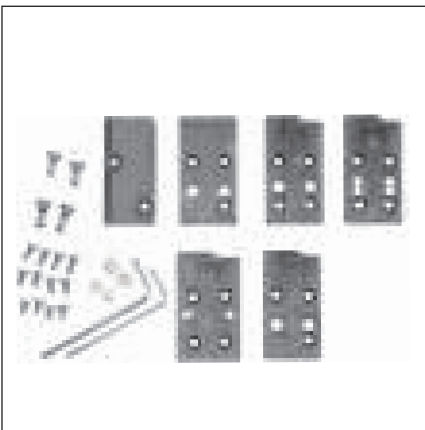

Figure OR3 - AOR interface plates, cover plate and included mounting hardware



Figure OR4 - Removing the Arex Optics Ready slide cover plate

NOTE: Although Arex delta OR interface plates were designed and tested with specific sights, compatibility with other sights that share the same footprint is not excluded. Insure that the reflex sight you intend to mount on the pistol fits one of the plates exactly and that appropriate plate is selected for mounting (see the above list).

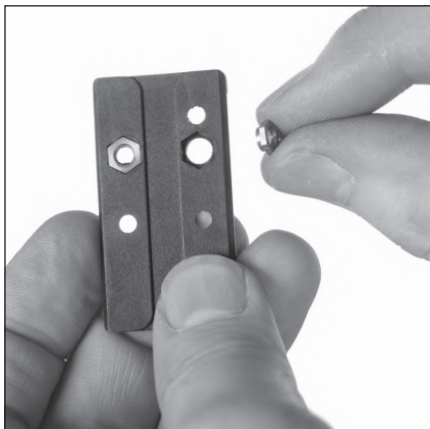

Figure OR5 - Inserting threaded hex nuts into their slots in the interface plate



Figure OR6 - Mounting the appropriate interface plate

The AOR platform set includes three sets of M3 screws with countersunk Allen (hex) socket heads in three lengths with appropriate Allen key (2,5 mm) for mounting the interface plates and some optical sights. Mounting hardware includes two pairs of hex nuts (M3 and M4) that have to be inserted in the chosen mounting plate (cylindrical end first), depending on the reflex sight to be mounted. Also included are two pairs of flat Allen socket head M4 screws in two lengths with appropriate Allen key (3 mm) for mounting specific optics.

To mount a chosen reflex optic ("red dot") onto the AREX delta slide, first clear the firearm (see Clearing, Pg. 15). Remove the OR cover plate secured in place with two M3 screws (use the included 2,5 mm Allen key).

Choose the applicable OR interface plate, insert two appropriate hex nuts into the plate (depending on the reflex sight to be mounted, see Figure OR5), then place it on the slide orienting it correctly. Choose the appropriate length of the countersunk head screws and apply a small amount of non-permanent thread locking compound (such as Loctite 243) to threads only (barely covering the threads). Tighten all four screws (if possible) to fix the AOR interface plate to the slide of the AREX delta. Do not overtighten. Tighten to 2 Nm (12 in-lb) using a torque wrench or hand tighten by inserting the short end of the provided Allen key into the socket head then turning it till slight flex is felt in the key. With the AOR interface plate mounted correctly, you can proceed with installation of the specific reflex sight according to the directions of the sight manufacturer preferably using mounting hardware (M3 or M4 fasteners) included with the AOR platform.



WARNING: It is the owner's responsibility to be absolutely certain that any chosen optical sight fits the chosen OR interface plate and is installed properly. Improper installation of an accessory may result in shifting point of impact, a dangerous malfunction, damage to the firearm, and serious injury to the shooter and other persons. The owner of the pistol and installer of accessories accepts full responsibility for the correct installation and functioning of the firearm after any such installation.

NOTE: Only fire the AREX delta with the AOR cover plate mounted or an interface plate AND reflex sight installed.

ACCESSORIES

RAIL MOUNTED ACCESSORIES

The AREX *delta* has a universal interface rails molded in the dustcover (the front, lower portion of the frame). This interface allows the operator to mount a wide variety of lights, laser aimers and other accessories to the handgun by means of the simple and proven universal interface (see Figure 53, 54).



Figure 53 — Installing accessory weapon light / laser module onto the rails



Figure 54 — Accessory laser aiming module mounted on AREX *delta*



WARNING: Always ensure the AREX *delta* pistol is “clear” before installing or removing accessories.

To avoid damage to the accessory and the AREX *delta*, carefully follow the instructions of the manufacturer for installing, operating, and removing a particular accessory from the mounting rails. Most lights, laser aimers, and similar accessories are installed by sliding them onto the front of the rail system while depressing a locking mechanism or clipping them on from the bottom.

NOTE: Weight of any frame (dust cover) mounted accessories should not exceed 11 ounces (300 grams) to ensure reliable function. The accessory might not fit correctly if it is not adjustable or it was not manufactured specifically for the AREX *delta* pistol.

For a list of accessories that fit the AREX *delta* pistol, contact your local Arex distributor.

CAUTION: Improperly designed or installed accessories may result in damage to the mounting interface and/or the pistol. Such damage is not covered under warranty.

NOTE: If after reviewing this manual you still have questions, please contact your local Arex distributor (see details on the back cover) or Arex Customer Service Department by e-mail support@arex.si

SECTION 8

PARTS LIST & EXPLODED VIEW

Parts Policy

Arex Customer Service Department maintains a full complement of replacement parts. Even though most gunsmiths have the knowledge, training, and the ability to make necessary repairs to your firearm, the skill and workmanship of any particular gunsmith is quite beyond our control.

NOTE: Should your firearm ever require service, we strongly recommend that you contact your local Arex distributor to determine if and how it should be sent in for service (see details on the back cover, see Service Policy, Pg. 41). The AREX *delta* pistol is a precision instrument built to highest standards and tight tolerances so original replacement parts will generally require no fitting.

If any part is ordered without returning the firearm to Arex, the customer takes full responsibility for ensuring that the part supplied is correct for their particular firearm and is properly installed and fitted by a qualified gunsmith.

AREX d.o.o. CANNOT BE HELD RESPONSIBLE FOR THE FUNCTIONING OF ANY FIREARM WHICH IS MODIFIED IN ANY WAY OR IN WHICH REPLACEMENT PARTS ARE INSTALLED BY THIRD PARTIES.



WARNING: It is the purchaser's responsibility to be absolutely certain that any parts ordered from the factory are correctly fitted and installed. Firearms are complicated mechanisms and improper installment of parts or any modification may result in a dangerous malfunction, damage to the firearm, and serious injury to the shooter and other persons. The purchaser and installer of parts accepts full responsibility for the correct adjustment and functioning of the firearm after such installation or modification.

PARTS LIST (see Pg. 46 — exploded view — Figure 55)

ITEM DESCRIPTION	CODE	ITEM DESCRIPTION	CODE	ITEM DESCRIPTION	CODE	ITEM DESCRIPTION	CODE				
1	FRAME L	503355	10	STRIKER	503340	27	SEAR SPRING	402012	48	STRIKER BLOCK PLUNGER (3DS)	402274
1	FRAME M	503329	11	LOADED CHAMBER INDICATOR (BR)	503147	28	SAFETY POSITIONING PIN	501240	49	STRIKER BLOCK SPRING	402339
1	FRAME X	503358	11	LOADED CHAMBER INDICATOR (STD.)	402007	29	DISCONNECTOR SPRING	402019	50	SLIDE COVER PLATE	501912
2	GRIP BACK STRAP SMALL (L X FRAME)	503229	12	OR COVER PLATE	503238	30	FRONT FRAME INSERT / UNLOCKING BLOCK	402020	51	STRIKER SLEEVE	501955
2	GRIP BACK STRAP SMALL (M FRAME)	503325	13	MOUNTING PLATE OR TYPE 1	503232	31	TRIGGER	501276	52	STRIKER RETAINER CUP	501974
3	GRIP BACK STRAP MEDIUM (L X FRAME)	503228	14	MOUNTING PLATE OR TYPE 2	503233	32	TRIGGER SAFETY LATCH (3DS)	501519	53	STRIKER SPRING	402359
3	GRIP BACK STRAP MEDIUM (M FRAME)	503326	15	MOUNTING PLATE OR TYPE 3	503234	33	TRIGGER SAFETY LATCH SPRING	402024	54	STRIKER REBOUND SPRING	402484
4	GRIP BACK STRAP LARGE (L X FRAME)	503227	16	MOUNTING PLATE OR TYPE 4	503235	34	TRIGGER BAR	501712	55	LOADED CHAMBER INDICATOR SPRING	402009
4	GRIP BACK STRAP LARGE (M FRAME)	503327	17	MOUNTING PLATE OR TYPE 5	503236	35	TRIGGER SAFETY LEVER AXLE	402008	56	LOADED CHAMBER INDICATOR AXLE	402041
5	GRIP BACK STRAP EXTRA LARGE (L X FRAME)	503225	18	BARREL (L)	503194	36	SLIDE CATCH / RELEASE (AMB)	402061	57	RECOIL SPRING GUIDE	502009
5	GRIP BACK STRAP EXTRA LARGE (M FRAME)	503328	18	BARREL (M, X)	502641	37	TRIGGER / SLIDE CATCH SPRING	402062	58	RECOIL SPRING RETAINER CUP	502035
6	EJECTOR	503400	19	MAGAZINE (X, L) 17RD	503155	38	TRIGGER AXLE	502046	59	RECOIL SPRING	402637
7	SLIDE L OR	503205	19	MAGAZINE (M) 15RD	503183	39	MAGAZINE RELEASE BUTTON (AMB)	501713	60	M3 FASTENER SET OR	402320
7	SLIDE M	503196	20	MAGAZINE (L, X) 17+2RD	503156	40	MAGAZINE CATCH	402046	61	THREADED OR PLATE INSERT M3	503149
7	SLIDE X	503351	20	MAGAZINE (M) 15+2RD	503182	41	MAGAZINE CATCH SPRING	402048	62	THREADED OR PLATE INSERT M3	503148
7	SLIDE M OR	503142	21	REAR FRAME INSERT / TRIGGER HOUSING	401208	42	MAGAZINE CATCH AXLE	402198	63	SAFETY LEVER - LEFT	503345
7	SLIDE X OR	503354	22	DISCONNECTOR / SEAR SAFETY RAMP (3DS)	401425	43	DISASSEMBLY LATCH	402206	64	SAFETY LEVER - RIGHT	503339
7	SLIDE L	503181	23	SEAR LEVER	401730	44	DISASSEMBLY LATCH SPRING	402250	65	SAFETY LEVER PIN	402035
8	FRONT SIGHT	503145	24	SEAR	401874	45	FRAME PIN	402254	66	M4 FASTENER SET + KEY	502242
9	REAR SIGHT OR	503146	25	SEAR LEVER AXLE	502484	46	GRIP BACK STRAP / LANYARD PIN	402255			
9	REAR SIGHT (STD.)	402636	26	SEAR AXLE	401882	47	EXTRACTOR	501899			

Figure 55 — AREX *delta* Exploded Diagram

AREX *delta* gen.2

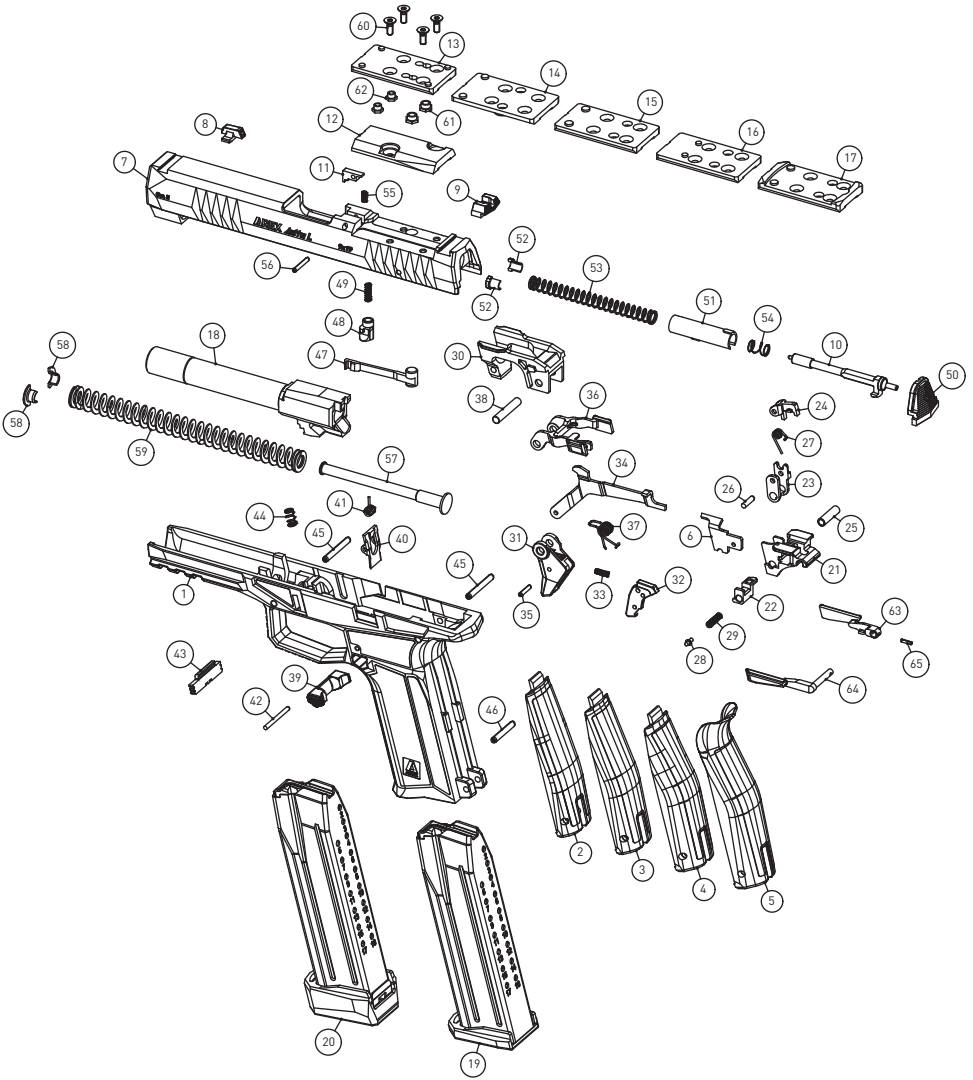



manufactured in EU
SLOVENIA

AREX

AREX d.o.o. Šentjernej
Trubarjeva cesta 7, SI-8310 Šentjernej, Slovenia, EU
NCAGE: 1064Q
Phone: +386 7 393 34 50 / Fax: +386 7 393 34 51
support@arex.si
www.arex.si